



Catalogo



GLOBALTE
Always Innovative





GLOBALTE[®]
Always Innovative

Siamo arrivati alla 5ª edizione del nostro catalogo, che continua ad essere un testimone prezioso della nostra storia, della nostra crescita e trasformazione. In tutti i cataloghi abbiamo cercato di trasmettere soprattutto la passione con cui cerchiamo ogni giorno di fare il nostro lavoro. Non abbiamo tradito la filosofia che abbiamo applicato nei precedenti cataloghi e quindi anche in quest'ultimo abbiamo cercato di riversare il meglio dei precedenti e i suggerimenti arrivati dal confronto continuo con i nostri clienti che non finiremo mai di ringraziare per questo e soprattutto per la fiducia che continuano ad accordarci. Le nuove potenzialità produttive e progettuali interne hanno portato un contributo facilmente notevole, sfogliando il catalogo, sui prodotti in vari materiali plastici e non e sui prodotti elettronici. E' difficile far intuire da un catalogo, che per forza di cose deve a con codici e descrizioni dettagliate, la nostra notevole flessibilità e capacità produttiva, possiamo solo invitare i nostri clienti a non esitare nel chiedere.

We arrived at the 5th edition of our catalog, which continues to be a precious witness of our history, of our growth and transformation. In all the catalogs we have tried to convey above all the passion with which we try every day to do our work. The spirit of our previous catalogues has been enhanced this year making this catalogue even better than the others. Our customers' suggestions and the continuous exchange with them were really useful, we will never stop to thank them for their trust and their precious collaboration. Our productive internal project potentialities brought new positive results in the production of plastic and non-plastic materials as well as of electronic products. Whenever our catalogue -with its codes and detailed descriptions - is not enough to make customers understand our remarkable flexibility and production ability, just contact us. We are available for any clarification. Please, do not hesitate; we are glad to help you!



GLOBALTE[®]
Always Innovative

La quinta edizione mantiene la struttura delle precedenti versioni. I prodotti sono divisi in diverse sezioni per dare una linea guida nella ricerca dei prodotti e delle soluzioni. Come nei cataloghi precedenti il codice di un prodotto va spesso completato aggiungendo due cifre finali per definire il colore. La tabella dei colori è notevolmente aumentata, ovvia conseguenza della possibilità data dalle macchine di stampa del gruppo.

L'indice analitico a fine catalogo aiuta nella ricerca di un codice specifico.

This fifth edition has the same structure of the previous ones. All our products are catalogued in different sections in order to help looking for different products and possible solutions. As in the past editions just adding to the code of a product two more digits you will get the colour. The colour table has been increased as a consequence of the new opportunities offered by the printing machines of the group. The index at the end of the catalogue helps when searching for a specific code.



LEGENDA COLORE

Colours

01 BIANCO White	17 DORATO Gold
02 BLU Blue	21 BEIGE Beige
03 GIALLO Yellow	22 GRIGIO CHIARO Light grey
04 MARRONE Brown	23 VIOLA Purple
05 NERO Black	24 ROSA Pink
06 ROSSO Red	31 ACCIAIO Steel
07 VERDE Green	32 ECRU Ecu
08 TRASPARENTE Transparent	33 TERRACOTTA Earthenware-like colour
09 ARANCIO Orange	34 LEGNO CHIARO Light wood
10 GRIGIO SCURO Dark grey	35 LEGNO SCURO Dark wood
12 SILVER Silver	98 NATURALE Natural color
13 AZZURRO Light blue	99 NON DEFINITO Undefined color
14 FUCSIA Fuchsia	

Colori Fluo

Fluorescent colours

50 GIALLO Yellow
51 ROSSO Red
52 VERDE Green
53 ARANCIO Orange
54 FUCSIA Fuchsia

Texture Legno

Wood texture

55 PINO Pine tree	60 PALISSANDRO Rosewood
56 ABETE Fir tree	W1 WOOD 1 Wood 1
57 CILIEGIO Cherry tree	W2 WOOD 2 Wood 2
58 FRASSINO Ash tree	W3 WOOD 3 Wood 3
59 NOCE Walnut tree	W4 WOOD 4 Wood 4

LEGENDA DELLA DISPONIBILITÀ

Availability

 Prodotti per i quali i tempi di evasione possono essere molto variabili, pertanto Vi consigliamo di contattarci preventivamente.
Products whose processing time may vary over time, therefore we suggest you to contact us in advance

 Prodotti con procedure di approvvigionamento e/o di produzione che normalmente garantiscono l'evasione in 15 giorni lavorativi
Products with procurement and / or production procedures normally available within 15 working days

 Prodotti con scorta a magazzino e quindi normalmente disponibili in 5 giorni lavorativi
Products with stock on hand and therefore available in 5 working days

I nostri codici sono concepiti per dare delle indicazioni immediate sui prodotti. Per completare il codice bisogna aggiungere, in coda, i 2 caratteri riferiti al colore. Se le ultime 2 cifre sono già inserite nel codice significa che non sono previsti colori diversi. Our codes are conceived to give immediate indication on products. To complete the codes you need to add the 2 colour characters at the end. If the last 2 digits are already included in the code product, different colours are not available.

Nota: Le foto sono solo indicative, l'azienda si riserva il diritto di modificare i prodotti a sua discrezione.

Note: Photos are for illustrative purpose only, the company reserves the right to change the products at any time and for any reason.

SISTEMI ESPOSITIVI

DISPLAY SYSTEMS



Contenitori Containers	8
Contenitori ortofrutta Fruit and vegetable containers	16
Cestini e contenitori Baskets and containers	18
Espositore baguette Baguette display	25
Alzate in PMMA PMMA risers	27
Divisori Dividers	33
Ardesia e finta ardesia Slate and fake slate	35
Taglieri e contenitori in essenza di legno Cutting boards and containers in wood essence	39
Vassoi fast food Fast food trays	42
Vaschette sovrapponibili Stackable trays	44
Complementi da banco Counter accessories	46
Decorazioni da banco Counter decorations	49
Finto food Fake Food	51

COMUNICAZIONE PREZZO

PRICE COMMUNICATION



Smart Card Printer Smart Card Printer	56
Segnaprezzi Price markers	62
Serie cancellabile Erasable series	66
Lavagne sagomate cancellabili Erasable shaped blackboard	78
Attacchi e accessori Attachments and accessories	84
Attacchi per segnaprezzi: aghi Attachments for price tags: needles	85
Attacchi per segnaprezzi: aste e bracci snodabili Attachments for price tags: articulated rods and hooks	87
Attacchi per segnaprezzi: mollette e pinze Attachments for pricetags: clamps and clips	88
Attacchi per segnaprezzi: mini piantane Attachments for price tags: mini floor lamps	92
Profili portaprezzo Data strip	95

COMUNICAZIONE GLOBALE

GLOBAL COMMUNICATION



Supporti promozionali Promotional supports	100
Promo Stop Promo Talkers	102
Cornici, cavalletti ed espositori Aluminum frames	113
Barra Double Double bar	125

ACCESSORI AREA VENDITA

SALES AREA ACCESSORIES



Copri Pallet Pallet Guards	132
Moduli espositivi Display modules	138
Rotoseller Rotoseller	145
Shopping baskets Shopping baskets	147
Stampa digitale Digital Print	154
Distributori guanti e sacchetti Glove dispensers and bags	163
Separatori e spingiprodotto Dividers and sliding forward systems	166
Accessori Accessories	179

PLEXIWORLD

PLEXIWORLD



Enoteca Wine shop	189
Pasticceria e gelateria Pastry and ice-cream shop	194
Finger food Finger food	196
Espositori Display Products	197
Moduli espositivi Display modules	203
Portamessaggi e targhe Message holders and plates	204
Contenitori e mensole Urns and shelves	206
Pelletteria e gioielleria Leather goods and jewelry	207

PREZZATRICI ETICHETTE ROTOLI

LABELLERS LABELS ROLLS



Rotoli Rolls	210
Linerless Linerless	214
Etichette adesive Adhesive labels	216
Etichette adesive per bilancia Adhesive labels for scale	217
Etichette promozionali Promotional Labels	219
Etichette termiche e a trasferimento termico Thermal labels and a thermal transfer	222
Cartoncini e frontolini Cards and fronts	223
Prezzatrici Labellers	225
Etichette per prezzatrici Labeling labels	230
Stampanti per etichette Label printers	236
Ribbon Ribbon	241

CONSUMABILI ANTITACCHEGGIO

ANTI-THEFT CONSUMABLES



Sistema acustico magnetico Magnetic acoustic systems	244
Sistema radiofrequenza Radio frequency systems	246

GESTIONE CODE E VIDEO COMUNICAZIONE

CODE MANAGEMENT AND VIDEO COMMUNICATION



Eliminacode No-queue system	252
Distributori Codalux touch Modello A Codalux touch Model A	254
Distributori Codalux touch Modello A Wall Codalux touch Model A Wall	255
Distributori Codalux touch ModelloB Codalux touch Model B	256
Codalux Codalux	257
Distributori ticket Ticket distributors	258
Box eliminacode multimediale Multimedial no-queue box	260
Visori gestione code Queue management displays	261
Software gestionali Management software	264
Videocomunicazione Videocommunication	265
Totem touch screen menù Touch screen totem menu	268
Libro ingredienti Ingredient book	269
Applicazioni ristorazione Catering applications	270
Nuove tecnologie New technologies	271

A still life photograph with a dark, moody atmosphere. In the foreground, a silver spoon is positioned diagonally across the frame. Below it, a wicker basket is partially visible, containing a large, round, golden-brown object, possibly a loaf of bread or a large vegetable. To the right, a dark bowl is filled with green peas, with a silver spoon resting inside. The background is dark and out of focus. The text 'DISPLAY Systems' is overlaid in the center, with 'DISPLAY' in a bold, cyan, sans-serif font and 'Systems' in a white, elegant script font.

DISPLAY
Systems



Sistemi

ESPOSITIVI



CONTENITORI CONTAINERS

I contenitori in PMMA, ABS e MELAMINA e le relative griglie in PP sono realizzati con materiali e processi produttivi in grado di garantire la piena conformità alle normative italiane ed europee riguardanti oggetti destinati a venire a contatto con i prodotti alimentari.

Norme di riferimento:

- Regolamento EU 1935/2004
- Regolamento EU 10/2011 e successivi emendamenti fino al Regolamento EU 1183/2012 • Regolamento CE 2023/2006 • DM del 21 marzo 1973
- DPR 777/82 e successivi aggiornamenti e modifiche
- DM n. 140 del 11 novembre 2013.

PMMA, ABS and MELAMINE containers and their related PP grids are made using materials and production processes, which are fully compliant to Italian and European safety Standards in regards to objects intended to be in contact with foods.

Regulations:

- EU Regulation 1935/2004
- EU Regulation 10/2011 and later amendments up to EU Regulation 1183/2012 - EC Regulation 2023/2006
- Italian Ministry decree of March 21st 1973
- Italian Republic President decree 777/82 and subsequent updates and changes
- Italian Ministry decree nr. 140 of 11 November 2013.



VASSOIO TRAY ANGOLI STONDATI NUOVO SISTEMA IMPILABILE
Rounded edge tray new stackable system

COMPOSIZIONE / MADE OF : PMMA
COLORI / COLOURS :

05 01

NEW

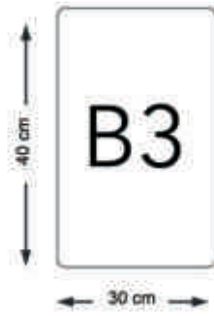

COD: SECTPN10 D: 40 x 30 x 10 H cm

VASSOIO TRAY ANGOLI STONDATI NUOVO SISTEMA IMPILABILE
Rounded edge tray new stackable system

COMPOSIZIONE / MADE OF : PMMA
COLORI / COLOURS :

05 01

NEW

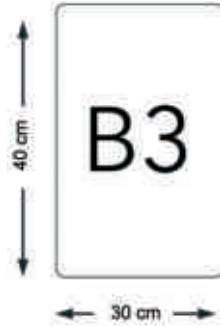

COD: SECTPN50 D: 40 x 30 x 5 H cm

VASSOIO TRAY ANGOLI STONDATI NUOVO SISTEMA IMPILABILE
Rounded edge tray new stackable system

COMPOSIZIONE / MADE OF : PMMA
COLORI / COLOURS :

05 01

NEW



COD: SECTPN30 D: 40 x 30 x 3 H cm

VASSOIO TRAY ANGOLI STONDATI NUOVO SISTEMA IMPILABILE

COMPOSIZIONE / MADE OF : PMMA
COLORI / COLOURS :

05 01

NEW

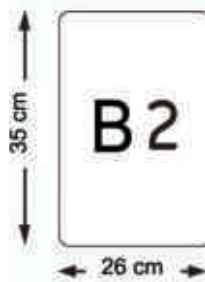

COD: SECTPM60 D: 35 x 26 x 6 H cm

VASSOIO TRAY ANGOLI STONDATI NUOVO SISTEMA IMPILABILE
Rounded edge tray new stackable system

COMPOSIZIONE / MADE OF : PMMA
COLORI / COLOURS :

05 01

NEXT

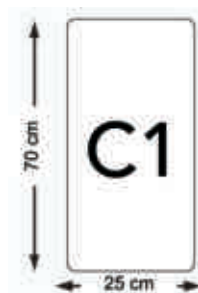

COD: SECTPM26 D: 70 x 25 x 2,6 H cm

VASSOIO TRAY MODELLO A6 CON BORDO STONDATO
A6 model tray with rounded edge

COMPOSIZIONE / MADE OF : PMMA
COLORI / COLOURS :

05 01

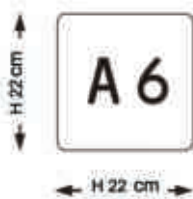

- ▶ COD: SECTP685 D: 22 x 22 x 8,5 H cm
- ▶ COD: SECTP650 D: 22 x 22 x 5 H cm
- ▶ COD: SECTP635 D: 22 x 22 x 3,5 H cm
- ▶ COD: SECTP626 D: 22 x 22 x 2,6 H cm

VASSOIO TRAY MODELLO A4 CON BORDO STONDATO
A4 model tray with rounded edge

COMPOSIZIONE / MADE OF : PMMA
COLORI / COLOURS :

05 01

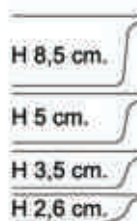

- ▶ COD: SECTP485 D: 29,5 x 22 x 8,5 H cm
- ▶ COD: SECTP450 D: 29,5 x 22 x 5 H cm
- ▶ COD: SECTP435 D: 29,5 x 22 x 3,5 H cm
- ▶ COD: SECTP426 D: 29,5 x 22 x 2,6 H cm

VASSOIO TRAY MODELLO A7 CON BORDO STONDATO
A7 model tray with rounded edge

COMPOSIZIONE / MADE OF : PMMA
COLORI / COLOURS :

05 01

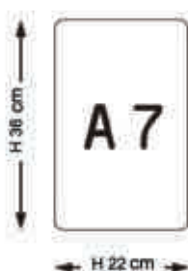

- ▶ COD: SECTP785 D: 36 x 22 x 8,5 H cm
- ▶ COD: SECTP750 D: 36 x 22 x 5 H cm
- ▶ COD: SECTP735 D: 36 x 22 x 3,5 H cm
- ▶ COD: SECTP726 D: 36 x 22 x 2,6 H m

VASSOIO TRAY MODELLO A5 CON BORDO STONDATO
A5 model tray with rounded edge

COMPOSIZIONE / MADE OF : PMMA
COLORI / COLOURS :

05 01

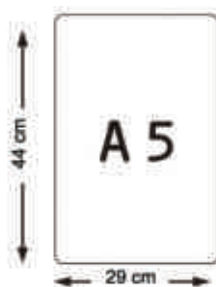

- ▶ COD: SECTP510 D: 44 x 29 x 10 H cm
- ▶ COD: SECTP585 D: 44 x 29 x 8,5 H cm
- ▶ COD: SECTP550 D: 44 x 29 x 5 H cm
- ▶ COD: SECTP535 D: 44 x 29 x 3,5 H cm
- ▶ COD: SECTP526 D: 44 x 29 x 2,6 H cm

VASSOIO TRAY MODELLO A3 CON BORDO STONDATO
A3 model tray with rounded edge

COMPOSIZIONE / MADE OF : PMMA
COLORI / COLOURS :

05 01

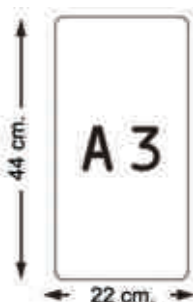

- ▶ COD: SECTP385 D: 44 x 22 x 8,5 H cm
- ▶ COD: SECTP350 D: 44 x 22 x 5 H cm
- ▶ COD: SECTP335 D: 44 x 22 x 3,5 H cm
- ▶ COD: SECTP326 D: 44 x 22 x 2,6 H cm

VASSOIO TRAY MODELLO A1 CON BORDO VIVO
A1 model tray with raw cut edge

COMPOSIZIONE / MADE OF : PMMA
COLORI / COLOURS :

05 01

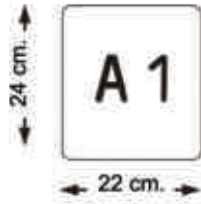

H 8,5 cm.

H 5 cm.

H 3,5 cm.

Bordi vivi
Raw cut edges

▶ COD: SECTP185 D: 24 x 22 x 8,5 H cm

▶ COD: SECTP150 D: 24 x 22 x 5 H cm

▶ COD: SECTP135 D: 24 x 22 x 3,5 H cm

VASSOIO TRAY MODELLO A2 CON BORDO VIVO
A2 model tray with raw cut edge

COMPOSIZIONE / MADE OF : PMMA
COLORI / COLOURS :

05 01

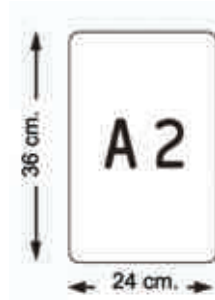

H 8,5 cm.

H 5 cm.

H 3,5 cm.

Bordi vivi
Raw cut edges

▶ COD: SECTP285 D: 36 x 24 x 8,5 H cm

▶ COD: SECTP250 D: 36 x 24 x 5 H cm

▶ COD: SECTP235 D: 36 x 24 x 3,5 H cm

VASSOIO TRAY MODELLO H CON BORDO STONDATO
H model tray with rounded edge

COMPOSIZIONE / MADE OF : PMMA
COLORI / COLOURS :

05 01

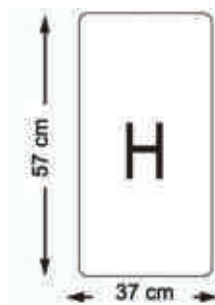

H 2,6 cm

▶ COD: SECTP026 D: 57 x 37 x 2,6 H cm

VASSOIO TRAY MODELLO L CON BORDO STONDATO
L model tray with rounded edge

COMPOSIZIONE / MADE OF : PMMA
COLORI / COLOURS :

05 01

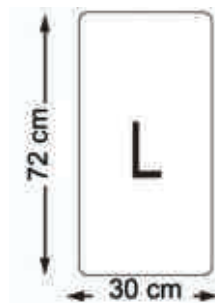

H 2,6 cm

▶ COD: SECTPL26 D: 72 x 30 x 2,6 H cm

VASSOIO CIRCOLARE Ø 26 cm
Round tray Ø 26 cm

COMPOSIZIONE / MADE OF : PMMA
COLORI / COLOURS :

▶ COD: SECTPX26 D: Ø 26 cm

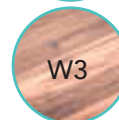
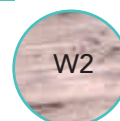

N. B. : Per altri diametri chiedere
N. B. : Ask for other diameters

GRIGLIA GRID

Griglia Tray modulare per contenitori
Tray modular grids for containers



La griglia in LDPE è subito utilizzabile con i modelli A5, ma può essere adattata ad altri vassoi della serie Tray (A6, A4, A7, A3, B3, B2), tagliando lungo le tacche o comunque con le dimensioni preferite.

The LDPE grid can be used immediately with A5 models, but it can also be adapted to fit other trays of the Tray series (A6, A4, A7, A3, B3, B2), by cutting around the marked notches.

GRIGLIA MODULARE PER VASSOI
Modular grid for containers

05 01

COD: SECTGRTY D: 38,5 x 24,5 cm

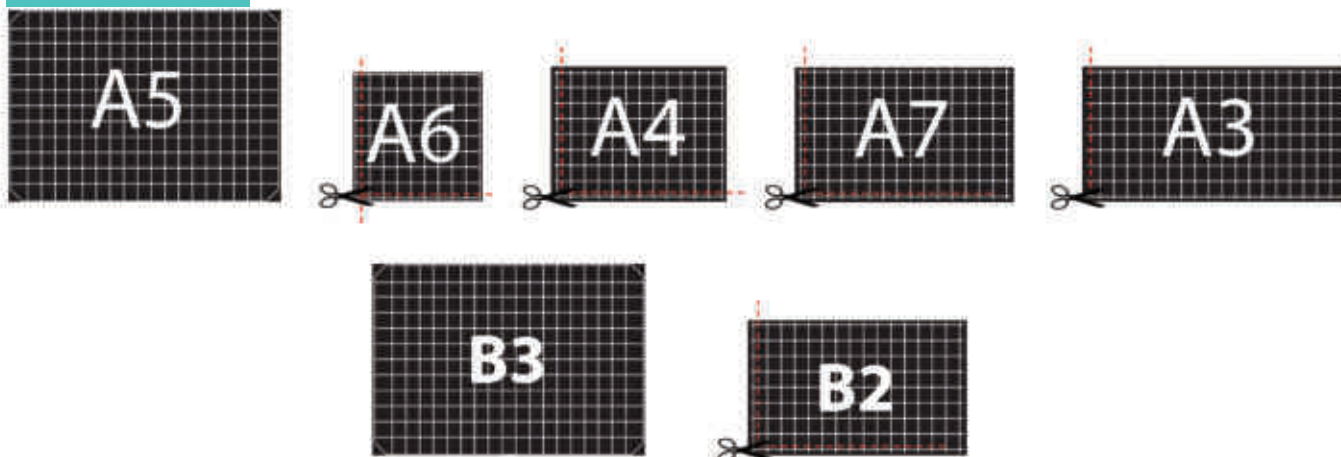

COPERCHI LIDS

Coperchi in PMMA con doppia apertura
PMMA lids with a double opening

COPERCHIO CON DOPPIA APERTURA
Double opening lid

► COD: SECTLDF108 D: 24 x 22 cm



COPERCHIO CON DOPPIA APERTURA
Double opening lid

► COD: SECTLDF208 D: 36 x 24 cm



COPERCHIO CON DOPPIA APERTURA
Double opening lid

► COD: SECTLDF308 D: 44 x 22 cm



COPERCHIO CON DOPPIA APERTURA
Double opening lid

► COD: SECTLDC408 D: 29,5 x 22 cm



COPERCHIO CON DOPPIA APERTURA
Double opening lid

► COD: SECTLDG508 D: 44 x 29 cm



COPERCHIO CON DOPPIA APERTURA
Double opening lid

► COD: SECTLD1608 D: 22 x 22 cm



COPERCHIO CON DOPPIA APERTURA
Double opening lid

► COD: SECTLDD708 D: 36 x 22 cm



B2

COPERCHIO CON DOPPIA APERTURA
Double opening lid

► COD: SECTCPF208 D: 35 x 26 cm

B3

COPERCHIO CON DOPPIA APERTURA
Double opening lid

► COD: SECTCPF308 D: 40 x 30 cm

Coperchi in PMMA di spessore 5 mm con doppia asola per mestoli e fuoriuscita di vapore (anticondensa). Taglio laser e piega a caldo.

5 mm thick PMMA covers with a double buttonhole for spoons and vapor – escaping (anti-condensation) Laser cut and hot folded



KIT

Realizzati in materiale plastico ultra resistente i vassoi dei Kit Tray rendono la composizione del vostro bancone rapida ed intuitiva. Grazie agli elementi componibili, di vari formati e colori, realizzerete un'esposizione ordinata e accattivante, così da rendere irresistibili i vostri prodotti.

Made of highly resistant plastic material, these kit trays can make your sale stand easy and fast to use. Thanks to their different shapes and colours these modular elements will make it possible for you to get a clean and attractive stand, making your products irresistible.



KIT
kit

05 01

È possibile scegliere tra diversi kit composti da vassoi in PMMA di vari colori, altezze e dimensioni
 You can choose between different kits made of PMMA trays of various colours, heights and sizes



N. B. : Per colori diversi da bianco e nero chiedere.
 N. B.: You can ask for colours other than black and white.

KIT ANFITEATRO

AMPHITHEATER KIT

La foto è solo di riferimento. È possibile acquistare 2 kit diversi tra loro.
 The photo is for reference only. You can buy 2 different kits from each other.

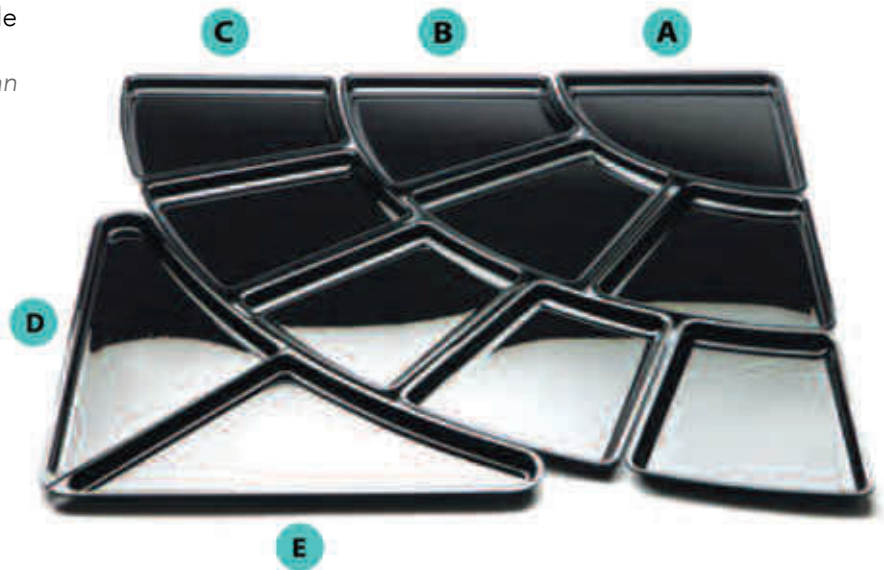

KIT 1ª VERSIONE

Kit 1st version

KIT COMPLETO

Complete kit

▶ COD: SECTPMA105



▶ COD: SECTPMCC05

D : 15 x 26 x 4 cm



▶ COD: SECTPMAA05

D : 27,5 x 27,5 x 4 cm



▶ COD: SECTPMBB05

D : 16,5 x 25 x 4 cm



▶ COD: SECTPMDD05

D : 52 x 38 x 4 cm



▶ COD: SECTPMEE05

D : 52 x 38 x 4 cm

KIT 2ª VERSIONE

Kit 2nd version

Al contrario della 1ª versione, questa 2ª versione è h 2 cm e ha anche le dimensioni dei singoli vassoi leggermente diverse.
 Unlike the 1st version, this 2nd version is h 2 cm and also has the dimensions of the individual trays slightly different.

KIT COMPLETO

Complete kit

▶ COD: SECTCR0205



▶ COD: SECTYSC3

D : 19 x 28 x 2 cm



▶ COD: SECTYSC5

D : 28 x 28 x 2 cm



▶ COD: SECTYSC1

D : 17 x 28 x 2 cm



▶ COD: SECTYTL1

D : 58 x 35 x 2 cm



▶ COD: SECTYTR1

D : 58 x 35 x 2 cm



CONTENITORI ORTOFRUTTA

Fruit containers

Una novità di questo catalogo sono i vassoi da esposizione a parete di prodotti ortofrutticoli che completano la nostra offerta per questo settore che comprende già altre proposte come isole espositive. I vassoi forex sono prodotti internamente e possono quindi essere facilmente personalizzati e adattati a varie dimensioni.

A new item in this catalogue is represented by the fruit and vegetable wall mounted display trays, which complete our offer for this section along with other solutions, such as the display islands. The forex trays are produced internally so they can be easily customized.



CONTENITORE ORTOFRUTTA
Fruit and vegetable container

COMPOSIZIONE / MADE OF : FOREX



Contenitore Ortofrutta con fascia da 7 cm
Fruit and vegetable container with 7 cm band

► COD: SECTFX0705 D: 36 x 22 x 7 H cm

Contenitore Ortofrutta con fascia da 12 cm
Fruit and vegetable container with 12 cm band

► COD: SECTFX1205 D: 36 x 22 x 12 H cm

Fascia supplementare da 7 cm
Additional band 7 cm forex

► COD: SEACFX0705

Fascia supplementare da 12 cm
Additional band 12 cm forex

► COD: SEACFX1205



► COD: CPLAF6VS05

Segnaprezzo in forex per ortofrutta A6

Price tag for fruit and vegetables in forex A6



Coppia di mensole per attacco a barra
Pair of shelves for bar attachment

► COD: SEMNFE3605 D: 38,5 x 4 H cm

Materiale: ST
Material: ST



Barra per aggancio a murale cm 125
Wall mounting bar 125 cm

► COD: SEDPBSP105

Materiale: ST
Material: ST

CONTENITORE STANDARD IN TERMOFORMATURA
Standard thermoforming container

COMPOSIZIONE / MADE OF: ABS



Contenitore Standard in termoformatura
Standard thermoforming container

► COD: SEDPCF0105 D: 36 x 22 x 12 H cm



Coppia di mensole per attacco a barra
Pair of shelves for bar attachment

► COD: SEMNFE3605 D: 38,5 x 4 H cm

Materiale: ST
Material: ST



Barra per aggancio a murale cm 125
Wall mounting bar 125 cm

► COD: SEDPBSP105

Materiale: ST
Material: ST



CESTINI E CONTENITORI

Baskets and containers

I cesti in polipropilene e acciaio inox sono realizzati con materiali e processi produttivi in grado di garantire l'idoneità al contatto con cereali, panini, pizza, paste secche, frutta, ortaggi, crostacei e molluschi, formaggi interi, alimenti secchi. La presenza dell'acciaio inox come elemento strutturale di rinforzo consente il trattamento in lavastoviglie.

Norme di riferimento:

- Regolamento EU 1935/2004
- Regolamento EU 10/2011 e successivi emendamenti fino al Regolamento EU 1183/2012 • Regolamento CE 2023/2006 • DM del 21 marzo 1973
- DPR 777/82 e successivi aggiornamenti e modifiche
- DM n. 140 del 11 novembre 2013.



Stainless steel and polypropylene baskets are suitable to be in contact with food (cereals, bread, pizza, dry pastry, fruits, vegetables, shellfish, whole-milk cheese, dry food products). They're also dishwasher safe since they are made of reinforced stainless steel.

Reference standards:

- EU Regulation 1935/2004
- EU Regulation 10/2011 and later amendments up to EU Regulation 1183/2012 - EC Regulation 2023/2006
- Italian Ministry decree of March 21st 1973
- Italian Republic President decree 777/82 and later up- dating and modifications
- Italian Ministry decree nr. 140 of 11 November 2013.



CESTO CIRCOLARE
Steel-framed circular basket



CESTO RETTANGOLARE
Steel-framed rectangular basket



▶ **COD: SECBBG3017** D: Ø 30 x 38 cm

▶ **COD: SECBBG6417** D: 60 x 40 x 60 cm

CESTO RETTANGOLARE
Steel-framed rectangular basket

VASSOIO A5 H 85
Tray model A5 H85

CESTO CON CONTENITORE
Basket with black container

05 01



▶ **COD: SECBC10032** D: 45 x 32 x 9,5 H cm

▶ **COD: SECTP585** D: 44 x 29 x 8,5 H cm

▶ **COD: SECBC15532** D: 45 x 32 x 9,5 H cm

CESTO RETTANGOLARE
Steel-framed rectangular basket

VASSOIO A7 H 85
Tray model A7 H85

CESTO CON CONTENITORE
Basket with black container

05 01



▶ **COD: SECBC20032** D: 37 x 25 x 9,5 H cm

▶ **COD: SECTP785** D: 36 x 22 x 8,5 H cm

▶ **COD: SECBC27532** D: 37 x 25 x 9,5 H cm

CESTO QUADRATO
Steel-framed square basket

VASSOIO A6 H 85
Tray model A6 H85

CESTO CON CONTENITORE
Basket with black container

05 01



▶ **COD: SECBC30032** D: 23 x 23 x 9,5 H cm

▶ **COD: SECTP685** D: 22 x 22 x 8,5 H cm

▶ **COD: SECBC36532** D: 23 x 23 x 9,5 H cm

CESTO QUADRATO SMALL
Small square basket



▶ COD: SECBSQ1632 D: 29 x 29 x 16 H cm

INSERTO QUADRATO DA 4,5 LT
4.5 Lt. square container



▶ COD: SECTPY0905 D: 31,5 x 31,5 x 9 H cm

CESTO CON INSERTO DA 4,5 LT
Small basket with 4.5 Lt. container



▶ COD: SECBS51632 D: 31,5 x 31,5 x 16 H cm

CESTO QUADRATO SMALL
Small square basket



▶ COD: SECBSQ1632 D: 29 x 29 x 16 H cm

INSERTO QUADRATO DA 6,5 LT
6.5 Lt. square container



▶ COD: SECTPY1605 D: 31,5 x 31,5 x 16 H cm

CESTO CON INSERTO DA 6,5 LT
Small basket with 6.5 Lt. container



▶ COD: SECBS61232 D: 31,5 x 31,5 x 16 H cm

CESTO QUADRATO BIG
Big square basket



▶ COD: SECBSQ2232 D: 29 x 29 x 22 H cm

INSERTO QUADRATO 4,5 LT
4.5 Lt. square container



▶ COD: SECTPY0905 D: 31,5 x 31,5 x 9 H cm

CESTO CON INSERTO DA 4,5 LT
Big basket with 4.5 Lt. container



▶ COD: SECBS52232 D: 31,5 x 31,5 x 22 H cm

CESTO QUADRATO BIG
Big square basket



▶ COD: SECBSQ2232 D: 29 x 29 x 16 H cm

INSERTO QUADRATO DA 6,5 LT
6.5 Lt. square container



▶ COD: SECTPY1605 D: 31,5 x 31,5 x 22 H cm

CESTO CON INSERTO DA 6,5 LT
Big basket with 6.5 Lt. container



▶ COD: SECBS62232 D: 31,5 x 31,5 x 16 H cm

CESTO CIRCOLARE SMALL
Small steel-framed round basket



▶ COD: SECB140032 D: Ø 32 x 16 H cm

INSERTO CIRCOLARE 4,5 LT
4.5 Lt. capacity container



▶ COD: SECTIC4505 D: Ø 30,5 x 9 H cm

CESTO CON INSERTO 4,5 LT
Small basket with 4.5 Lt. container



▶ COD: SECB144532 D: Ø 32 x 16 H cm

CESTO CIRCOLARE SMALL
Small steel-framed round basket



▶ COD: SECB140032 D: Ø 32 x 16 H cm

INSERTO CIRCOLARE 6,5 LT
6.5 Lt. capacity container



▶ COD: SECTIC6505 D: Ø 30,5 x 15 H cm

CESTO CON INSERTO 6,5 LT
Small basket with 6.5 Lt. container



▶ COD: SECB146532 D: Ø 32 x 16 H cm

CESTO CIRCOLARE BIG
Big steel-framed round basket



▶ COD: SECB210032 D: Ø 32 x 22 H cm

INSERTO CIRCOLARE 4,5 LT
4.5 Lt. capacity container



▶ COD: SECTIC4505 D: Ø 30,5 x 9 H cm

CESTO CON INSERTO 4,5 LT
Big basket with 4.5 Lt. container



▶ COD: SECB214532 D: Ø 32 x 22 H cm

CESTO CIRCOLARE BIG
Big steel-framed round basket



▶ COD: SECB210032 D: Ø 32 x 22 H cm

INSERTO CIRCOLARE 6,5 LT
6.5 Lt. capacity container



▶ COD: SECTIC6505 D: Ø 30,5 x 15 H cm

CESTO CON INSERTO 6,5 LT
Big basket with 6.5 Lt. container



▶ COD: SECB216532 D: Ø 32 x 22 H cm

CESTO QUADRATO IN POLIPROPILENE PIENO Ø 5 MM
Square basket in full polypropylene ø 5 mm

COMPOSIZIONE / MADE OF: PP
 COLORI / COLOURS :

05 04



► COD: SECBCS02 D: 30 x 30 x 8 H cm

CESTO RETTANGOLARE IN POLIPROPILENE PIENO Ø 5 MM
Ø 5 mm full polypropylene rectangular basket

COMPOSIZIONE / MADE OF: PP
 COLORI / COLOURS :

05 04 17
 *



► COD: SECBCS01 D: 30 x 22,5 x 8 H cm

► COD: SECBCS03 * D: 40 x 30 x 10 H cm

► COD: SECBCS06 D: 45 x 30 x 10 H cm

CESTO RETTANGOLARE A DUE ALTEZZE IN POLIPROPILENE Ø 5 MM
Ø 5 mm full polypropylene rectangular basket with double heights

COMPOSIZIONE / MADE OF: PP
 COLORI / COLOURS :

05 04



► COD: SECBCS07 D: 45 x 30 x 6/10 H cm

CESTO RETTANGOLARE A DUE ALTEZZE IN POLIPROPILENE Ø 5 MM
Ø 5 mm full polypropylene rectangular basket with double heights

COMPOSIZIONE / MADE OF: PP
 COLORI / COLOURS :

05 04



► COD: SECBCS08 D: 45 x 60 x 6/12 H cm

CESTO RETTANGOLARE IN POLIPROPILENE Ø 5 MM
 Ø 5 mm full polypropylene rectangular basket

COMPOSIZIONE / MADE OF: PP
 COLORI / COLOURS :

05 04



▶ COD: SECBCS20 D: 60 x 40 x 12 H cm

▶ COD: SECBCS09 D: 60 x 45 x 10 H cm

CESTO RETTANGOLARE IN POLIPROPILENE Ø 3 MM
 Ø 3 mm stainless steel-framed polypropylene rectangular basket

COMPOSIZIONE / MADE OF: PP
 COLORI / COLOURS :

05 04 17



▶ COD: SECBCA10 D: 30 x 25 x 3,5 H cm

CESTO RETTANGOLARE IN POLIPROPILENE Ø 3 MM
 Ø 3 mm stainless steel-framed polypropylene rectangular basket

COMPOSIZIONE / MADE OF: PP
 COLORI / COLOURS :

05 04 17



▶ COD: SECBCA03 D: 40 x 28 x 8 H cm

CESTO RETTANGOLARE IN POLIPROPILENE Ø 3 MM
 Ø 3 mm stainless steel-framed polypropylene rectangular basket

COMPOSIZIONE / MADE OF: PP
 COLORI / COLOURS :

05 04 17



▶ COD: SECBCA09 D: 40 x 30 x 3,5 H cm

▶ COD: SECBCA08 D: 45 x 30 x 3,5 H cm



CESTO RETTANGOLARE IN POLIPROPILENE Ø 3 MM
Ø 3 mm stainless steel-framed polypropylene rectangular basket

COMPOSIZIONE / MADE OF: PP

COLORI / COLOURS :



► COD: SECBCA02 D: 45 x 30 x 10 H cm

CESTO RETTANGOLARE IN POLIPROPILENE Ø 3 MM
Ø 3 mm stainless steel-framed polypropylene rectangular basket

COMPOSIZIONE / MADE OF: PP

COLORI / COLOURS :



► COD: SECBCA07 D: 60 x 30 x 3,5 H cm

CESTO RETTANGOLARE IN POLIPROPILENE Ø 3 MM
Ø 3 mm stainless steel-framed polypropylene rectangular basket

COMPOSIZIONE / MADE OF: PP

COLORI / COLOURS :



► COD: SECBCA01 D: 60 x 45 x 12 H cm



ESPOSITORE PANE

Bread display

La nostra gamma si arricchisce di un nuovo prodotto: l'espositore per baguette.

Questa pratica e leggera piantana consente di agganciare i cestì in vimini adatti al contenimento delle baguette. È adatto per panifici, ma anche per i supermercati.

La piantana è alta 60 cm è completamente smontabile senza l'utilizzo di viteria. Disponibile verniciata.

Our range of products now includes also a baguette display. This practical and light floor stand allows to hook the wicker baskets suitable for baguette containment. It is suitable for bakeries, but also for supermarkets. The floor stand is 60 cm high and can be completely dismantled without using screws. Available painted.



ESPOSITORE BAGUETTE
Baguette display



Espositore 1 cesto
1 basket display

COD: SEKTPB01 D: 60 H cm

Espositore 2 cesti
2 baskets displays

COD: SEKTPB02 D: 60 H cm

Espositore 3 cesti
3 baskets displays

COD: SEKTPB03 D: 60 H cm

Espositore 4 cesti
4 baskets displays

COD: SEKTPB04 D: 100 H cm

Espositore 5 cesti
5 baskets displays

COD: SEKTPB05 D: 100 H cm

CESTO
Steel-framed circular basket



SOSTEGNI PER CESTI
Holders for baskets



COD: SECBBG3017 D: Ø 30 x 38 cm

COD: SEKTPB06

ASTA PER ESPOSITORE
Display Pole



COD: SEKTPB07 D: 60 H cm

ESEMPI DI COMBINAZIONI
Possible combinations

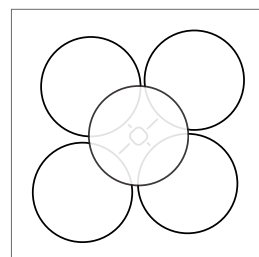
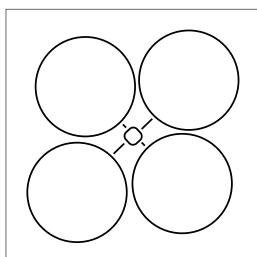
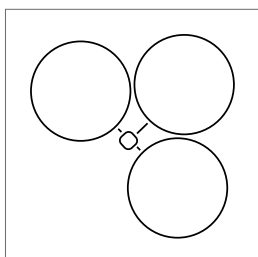
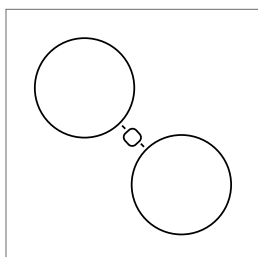
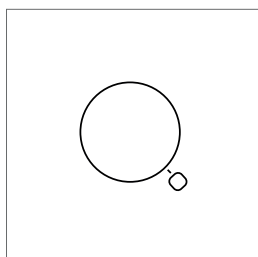



ALZATE IN PMMA 5 MM

PMMA 5 mm risers

La possibilità di lavorare il plexiglass e tanti altri materiali (vedi capitolo Stampa Digitale) internamente (taglio, piega e stampa) amplia notevolmente la nostra offerta di alzate. Nelle pagine seguenti ci sono alcuni esempi delle nostre soluzioni.

Processing plexiglass and other materials internally (i.e. cutting, folding and printing - see the Digital Printing Chapter), expanded our offer of risers. The following pages show some examples of our solutions.





ALZATA QUADRATA A CROCE
Cross-shaped square riser.

COMPOSIZIONE / MADE OF: PMMA
COLORI / COLOURS:

05 01 08



► COD: SECBRX05 D: 15 x 5 H cm

► COD: SECBRX10 D: 15 x 10 H cm

► COD: SECBRX15 D: 15 x 15 H cm

ESPOSITORE INCLINATO
Hot-moduled stand riser.

COMPOSIZIONE / MADE OF: PMMA
COLORI / COLOURS:

05 01 08



► COD: SECBEXP1 D: 28 x 20 x 11,5 H cm

► COD: SECBEST1 D: 28 x 20 x 11,5 H cm

ALZATA DA BANCO
Hot-moduled stand riser.

COMPOSIZIONE / MADE OF: PS
COLORI / COLOURS:

05 01



► COD: SECBAZ02 D: 81 x 44 X 7,5 H cm

► COD: SECBAZ01 D: 54 x 44 X 8 H cm

ALZATA DA BANCO 3 PIANI CON PIEGA LATO CORTO
Three-level-table riser with short folding edge



COMPOSIZIONE / MADE OF: PMMA
 COLORI / COLOURS:

- 05
- 01
- 08

► **COD: SECBAR03** Dimensioni / Size 1:
 40 x 25 x 8 H cm
 Dimensioni / Size 2:
 38,5 x 25 x 5 H cm
 Dimensioni / Size 3:
 37 x 25 x 3 H cm

Misure personalizzabili
Customizable sizes

ALZATA DA BANCO 3 PIANI CON PIEGA LATO LUNGO
Three-level-riser stand with long side fold



COMPOSIZIONE / MADE OF: PMMA
 COLORI / COLOURS:

- 05
- 01
- 08

► **COD: SECBAS03** Dimensioni / Size 1:
 40 x 25 x 8 H cm
 Dimensioni / Size 2:
 40 x 25 x 5 H cm
 Dimensioni / Size 3:
 40 x 25 x 3 H cm

Misure personalizzabili
Customizable sizes

ALZATA DA BANCO 3 PIANI CON PIEGA LATO LUNGO
Three-level-riser stand



COMPOSIZIONE / MADE OF: PMMA

► **COD: SECBAW03** Dimensioni / Size 1:
 40 x 25 x 8 H cm
 Dimensioni / Size 2:
 40 x 25 x 5 H cm
 Dimensioni / Size 3:
 40 x 25 x 3 H cm

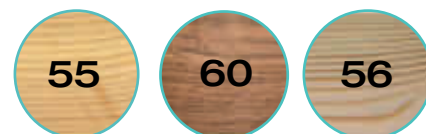

55 Pino Pine
 60 Palissandro Rosewood
 56 Abete Fir

Misure personalizzabili
Customizable sizes

ALZATA DA BANCO 3 PIANI CON SUPPORTI
Three-level-riser stand with holders



COMPOSIZIONE / MADE OF: PMMA
 COLORI / COLOURS:

- 05
- 01
- 08

► **COD: SECBAW03** Dimensioni / Size 1:
 40 x 25 x 8 H cm
 Dimensioni / Size 2:
 40 x 25 x 5 H cm
 Dimensioni / Size 3:
 40 x 25 x 3 H cm

Misure personalizzabili
Customizable sizes

SISTEMI ESPOSTIVI

ALZATA DA BANCO 3 PIANI IN PMMA FINITURA LUCIDA
Glossy finish PMMA three-level counter top stand riser

COMPOSIZIONE / MADE OF: PMMA 0,5 cm



► COD: SECBAF9005 D: 80 x 80 cm

ALZATA DA BANCO 3 PIANI IN FOREX FINITURA OPACA
Matte finish forex three-level counter top

COMPOSIZIONE / MADE OF: FOREX 1 cm



► COD: SECBAF9005 D: 80 x 80 cm

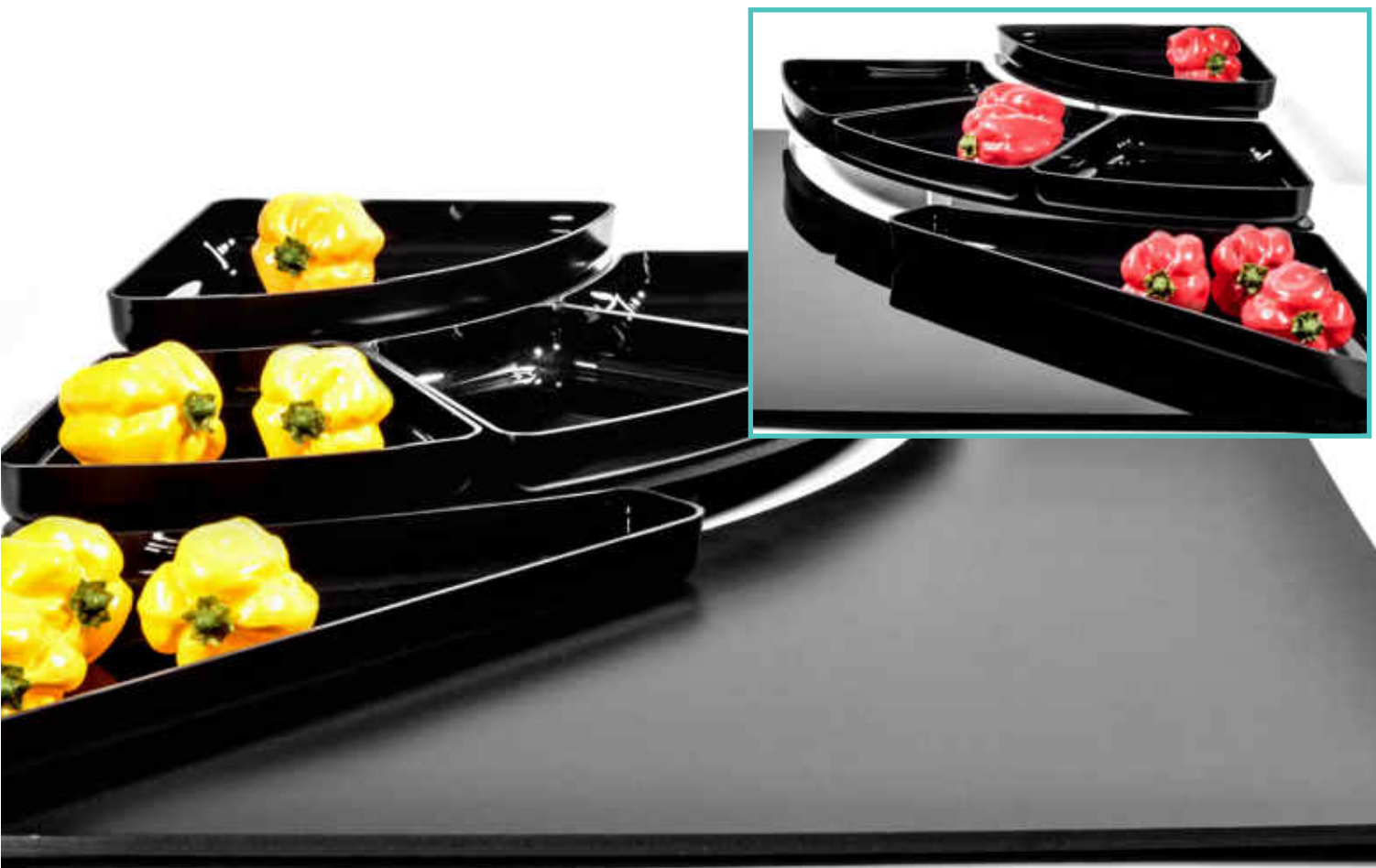



FINTA MASSA
Fake mass

COMPOSIZIONE / MADE OF: ABS

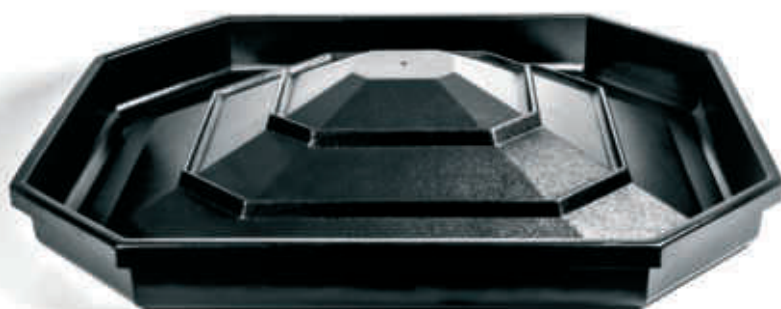

▶ **COD: SEEPBEC205** D: 107,8 x 89 x 21 H cm

FINTA MASSA
Fake mass

COMPOSIZIONE / MADE OF: ABS



▶ **COD: SEEPBO0220** D: 123 x 123 x 21 H cm

PORTABANANE
Banana holder

COMPOSIZIONE: POLISTIROLO COMPRESSO
MADE OF: COMPRESSED POLYSTYRENE



▶ **COD: SEPBMPI005** D: 60 x 40 x 13 H cm

Utilizzabile anche con le isole
espositive

To be used with display islands too



VETRINA PROTETTIVA
Prism shaped protecting glass



COMPOSIZIONE / MADE OF: PMMA

- ▶ COD: SECBVPX108 D: 22 / 17 x 45 X 20 H cm
- ▶ COD: SECBVPC208 D: 22 / 17 x 60 x 20 Hcm
- ▶ COD: SECBVPD308 D: 22 / 17 x 80 X 20 H cm



VETRINA PROTETTIVA
Prism-shaped protecting glass

COMPOSIZIONE / MADE OF: PMMA



- ▶ COD: SECBVT4408 D: 26 x 44 X 20 H cm
- ▶ COD: SECBVT6408 D: 26 x 65 x 20 H cm
- ▶ COD: SECBVT8608 D: 26 x 86 X 20 H cm

VETRINA PROTETTIVA
Prism-shaped protecting glass

COMPOSIZIONE MADE OF: PMMA



- ▶ COD: SECBV24408 D: 27 x 44 X 33 H cm
- ▶ COD: SECBV26408 D: 27 x 65 x 33 H cm
- ▶ COD: SECBV28608 D: 27 x 86 X 33 H cm



DIVISORI IN PMMA

PMMA Dividers

Sui divisori in plexi l'offerta è veramente completa.

Con la lavorazione interna del materiale (stampa, taglio, piega e incollaggio) si possono produrre con dimensioni e forme concordate con il cliente.

Una grande opportunità per organizzare la presentazione dei prodotti in modo chiaro e ordinato.

For plexi dividers our offer is really complete.

Thanks to internal processing of materials (printing, cutting, folding and gluing) we can produce customized dividers (both in dimensions and shapes) according to our customers' need.

A great opportunity to organize the presentation of products in a clear and clean way.



DIVISORI PERSONALIZZABILI NELLE SAGOME 3/5 mm Customized dividers in 3 mm or 5mm shapes



COMPOSIZIONE / MADE OF: PMMA

- È possibile realizzare divisori personalizzati in diverse forme e sagome, secondo esigenze specifiche.

It is possible to customize dividers in different sizes and shapes, according to specific needs.

DIVISORI INCOLLATI 5 mm 5 mm glued dividers



COMPOSIZIONE / MADE OF: PMMA

- COD: FC98DIV/17 D: 80 x 20 H cm
- COD: FC97DIV/17 D: 80 x 12 H cm
- COD: FC95DIV/17 D: 40 x 2 H cm

DIVISORI CON PIEDINI AD INCASTRO 3 mm 3 mm Dividers with interlocking feet



COMPOSIZIONE / MADE OF: PMMA + PC

- COD: SEDVR61508 D: 60 x 15 H cm
- COD: SEDVR71508 D: 70 x 15 H cm
- COD: SEDVR81508 D: 80 x 15 H cm
- COD: SEDVR63008 D: 60 x 30 H cm
- COD: SEDVR73008 D: 70 x 30 H cm
- COD: SEDVR83008 D: 80 x 30 H cm
- COD: SEDVHDR108 Piede Foot

DIVISORI CON PIEGA "A Z" 5 mm 5 mm Dividers with "AZ" bend

COMPOSIZIONE / MADE OF: PMMA



- Divisorio neutro o personalizzabile, con base realizzata in PMMA piegato a 90°.

Neutral or customizable divider with a PMMA basis bent at 90 degrees.

DIVISORI PERSONALIZZABILI CON STAMPA UV DIRETTA Direct UV printed customized dividers

COMPOSIZIONE / MADE OF: PMMA + PC



- È possibile realizzare divisori personalizzati con stampa diretta UV ad alta risoluzione. Sia mono che bifacciali.

We can customize dividers by a high resolution UV printing. They can be both single and double-sided.



ARDESIA E FINTA ARDESIA

Slate and slate-like

La presentazione di prodotti (in stile gourmet) è importante in ambiti e realtà commerciali sempre più diffusi.

I piatti in ardesia o in altri materiali che ne replicano forme e caratteristiche sono una delle opzioni principali da valutare. Le proposte delle pagine seguenti permettono di scegliere tra diverse possibilità in modo da poter selezionare i prodotti più adatti ad una specifica esigenza o scelta estetica.

Gourmet-style presentation of products is more and more important in widespread contexts and commercial situations.

Slate or other materials that repeat their shape and features are options to be taken into consideration. Our following proposals let you choose among different opportunities in order to make you select the most suitable ones either for a specific need or just for an aesthetic choice.



PIATTO RETTANGOLARE IN ARDESIA
Rectangular slate tray



COMPOSIZIONE: ARDESIA
 MADE OF : SLATE

- ▶ COD: SECTVA0105 D: 60 x 30 cm
- ▶ COD: SECTVA0205 D: 41 x 29 cm
- ▶ COD: SECTVA0305 D: 40 x 30 cm
- ▶ COD: SECTVA0405 D: 30 x 20 cm
- ▶ COD: SECTVA0505 D: 20 x 13 cm

PLACCA RETTANGOLARE IN ARDESIA GASTRONORM
Rectangular Gastronorm slate plate



COMPOSIZIONE: ARDESIA
 MADE OF : SLATE

- ▶ COD: SECTVA0605 D: 53 x 32,5 cm
- ▶ COD: SECTVA0705 D: 32,5 x 26,5 cm
- ▶ COD: SECTVA0805 D: 32,5 x 17,5 cm
- ▶ COD: SECTVA0905 D: 26,5 x 16,2 cm

PLACCA QUADRATA IN ARDESIA
Square slate plate



COMPOSIZIONE: ARDESIA
 MADE OF : SLATE

- ▶ COD: SECTVA1005 D: 31 x 31 cm
- ▶ COD: SECTVA1105 D: 30 x 30 cm
- ▶ COD: SECTVA1205 D: 25 x 25 cm
- ▶ COD: SECTVA1305 D: 22 x 22 cm

PIATTO RETTANGOLARE IN ARDESIA
Rectangular slate tray



COMPOSIZIONE: ARDESIA
 MADE OF : SLATE

- ▶ COD: SECTVA1505 D: 14 x 8 cm

PLACCA RETTANGOLARE IN ARDESIA
Rectangular slate plate



COMPOSIZIONE: ARDESIA
 MADE OF : SLATE

- ▶ COD: SECTVA1605 D: 32 x 15 cm
- ▶ COD: SECTVA1705 D: 30 x 10 cm

PLACCA CIRCOLARE IN ARDESIA
Round slate plate

COMPOSIZIONE: ARDESIA
MADE OF : SLATE

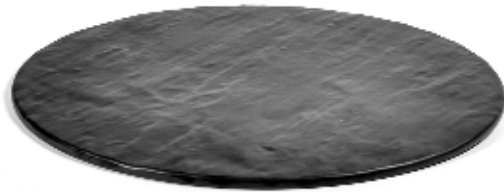

▶ COD: SECTVA1805 Ø 28,5 cm

▶ COD: SECTVA1905 Ø 33 cm

PIATTO QUADRATO IN ARDESIA
Square slate tray

COMPOSIZIONE: ARDESIA
MADE OF : SLATE



▶ COD: SECTDP0705 D: 30 x 30 cm

▶ COD: SECTDP0805 D: 25 x 25 cm

PIATTO RETTANGOLARE IN ARDESIA GASTRONORM
Gastronorm rectangular slate plate

COMPOSIZIONE: ARDESIA
MADE OF : SLATE



▶ COD: SECTDP0905 D: 32 x 26,5 cm

PIATTO RETTANGOLARE IN ARDESIA GASTRONORM
Gastronorm rectangular slate plate

COMPOSIZIONE: ARDESIA
MADE OF : SLATE



▶ COD: SECTDP1005 D: 32,5 x 17,5 cm

PIATTO RETTANGOLARE IN ARDESIA GASTRONORM
Gastronorm rectangular slate plate

COMPOSIZIONE: ARDESIA
MADE OF : SLATE



▶ COD: SECTDP1105 D: 53 x 16 cm



PIATTO RETTANGOLARE EFFETTO PIETRA GASTRONORM
Rectangular Gastronorm stone effect dish

COMPOSIZIONE: PORCELLANA
 MADE OF : PORCELAIN



- ▶ COD: SECTDP0105 D: 53 x 32,5 cm
- ▶ COD: SECTDP0205 D: 53 x 16 cm
- ▶ COD: SECTDP0305 D: 35 x 22 cm
- ▶ COD: SECTDP0405 D: 30 x 15 cm

PIATTO RETTANGOLARE IN MELAMINA EFFETTO ARDESIA NERO OPACO
Rectangular flat matt melamine slate-like dish

COMPOSIZIONE: MELAMINA
 MADE OF : MELAMIN

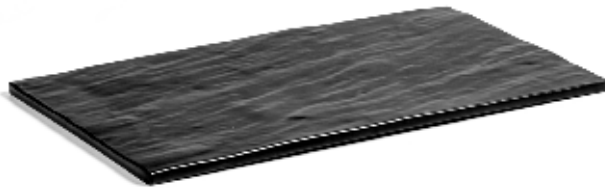

- ▶ COD: SECTBT0205 D: 52,4 x 32,3 x 0,9 H cm
- ▶ COD: SECTBT0305 D: 32,3 x 17,3 x 0,9 H cm

PIATTO QUADRATO IN MELAMINA EFFETTO ARDESIA NERO OPACO
Square melamine matt slate-like dish

COMPOSIZIONE: MELAMINA
 MADE OF : MELAMIN

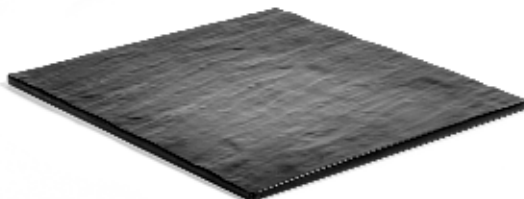

- ▶ COD: SECTBT0405 D: 32,5 x 32,5 x 0,9 H cm

PIATTO CIRCOLARE IN MELAMINA EFFETTO ARDESIA NERO OPACO
Round matt slate-like melamine dish

COMPOSIZIONE: MELAMINA
 MADE OF : MELAMIN

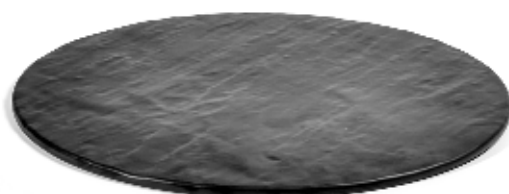

- ▶ COD: SECTBT0505 D: Ø 40 x 0,9 cm
- ▶ COD: SECTBT0605 D: Ø 33 x 0,9 cm



TAGLIERI E CONTENITORI IN ESSENZA DI LEGNO

*Wooden chopping boards and
containers*

Come per l'ardesia anche piatti ed espositori in legno diventano sempre più importanti nella presentazione dei prodotti. Alcune misure sono solo indicative perché, ad esempio, ricavate dal taglio di tronchi che non possono, ovviamente, avere sempre la stessa sezione.

L'azienda si impegna a rifornirsi, quando possibile, da fornitori che garantiscano la sostenibilità ambientale.

As for slate, even wooden plates and displays are becoming more and more important in product presentations. Some of the sizes are purely indicative because of the section cutting of logs which cannot always be the same.

Whenever possible our company undertakes to obtain supplies from companies that guarantee environmental sustainability.



TAGLIERE ROTONDO IN LEGNO
Round wooden chopping board



COMPOSIZIONE: LEGNO
MADE OF: WOOD

▶ COD: SECTWD2534 D: Ø 25 x 1,5 cm

▶ COD: SECTWD3034 D: Ø 30 x 1,5 cm

TAGLIERE ROTONDO IN LEGNO
Round wooden chopping board



COMPOSIZIONE: LEGNO
MADE OF: WOOD

▶ COD: SECTWD9634 D: Ø 30 X 1,5 cm

TAGLIERE ROTONDO IN LEGNO
Round wooden chopping board



COMPOSIZIONE: LEGNO
MADE OF: WOOD

▶ COD: SECTWD3035 D: Ø 30 x 2 cm

TAGLIERE RETTANGOLARE IN LEGNO
Rectangular wooden chopping board



COMPOSIZIONE: LEGNO
MADE OF: WOOD

▶ COD: SECTWD8134 D: 81 x 32 cm

TAGLIERE IN LEGNO
Wooden cutboard



COMPOSIZIONE: LEGNO
MADE OF: WOOD

▶ COD: SECTCT45 D: 45 x 20 x 1,5 cm

▶ COD: SECTCT55 D: 55 x 22 x 1,5 cm

▶ COD: SECTCT65 D: 65 x 23 x 1,8 cm

▶ COD: SECTCT75 D: 75 x 26 x 1,8 cm

Le misure riportate hanno una tolleranza di circa 5 cm.

The sizes shown have a 5 cm tolerance.

CASSETTA IN LEGNO
Wooden box

COMPOSIZIONE: LEGNO
MADE OF: WOOD



- ▶ COD: SECTCS2622 D: 26 x 16 x 14 H cm
- ▶ COD: SECTCS3122 D: 31 x 21 x 16 H cm
- ▶ COD: SECTCS4122 D: 41 x 31 x 20 H cm

CASSETTA IN LEGNO CON LAVAGNA
Wooden box with blackboard

COMPOSIZIONE: LEGNO
MADE OF: WOOD



- ▶ COD: SECTCS2601 D: 26 x 16 x 14 H cm
- ▶ COD: SECTCS3101 D: 31 x 21 x 16 H cm
- ▶ COD: SECTCS4101 D: 41 x 31 x 20 H cm

Completa di inserto per
segnaprezzo in finta ardesia.
With a slate-like price insert.

CASSETTA IN LEGNO
Wooden box

COMPOSIZIONE: LEGNO
MADE OF: WOOD



- ▶ COD: SECTCS3234 D: 32 x 27 x 10 H cm
- ▶ COD: SECTCS5334 D: 53 x 32 x 10 H cm

MOBILE IN LEGNO PORTA PANE/ PATATE
Wooden bread and potatoes cabinet

COMPOSIZIONE: LEGNO
MADE OF: WOOD



- ▶ COD: SECTPP3134 D: 31 x 25 x 44 H cm
- ▶ COD: SECTPP3734 D: 37 x 30 x 50 H cm



VASSOI FAST FOOD

Fast food trays

La possibilità di acquistare cibo e piatti pronti e di consumarli direttamente nel punto vendita è una realtà sempre più diffusa. La crescita della vendita on-line si affronta anche enfatizzando una vendita completamente "on-air". Per questo motivo, novità del catalogo, abbiamo una proposta completa di vassoi dedicati al fast food.

Buying ready to be eaten on the spot food or ready made meals is a widespread reality. The growth of online sales can be faced by enhancing a total "on-air" sale. That's why in the catalogue, we have a new complete proposal for fast food trays.



SEMPRE DISPONIBILI IN PRONTA CONSEGNA I VASSOI NEI COLORI NERO GRAFITE E ROSSO.

THE TRAYS IN BLACK GRAPHITE AND RED ARE ALWAYS AVAILABLE AND READY FOR DELIVERY.



VASSOIO GASTRONORM
Gastronorm tray



COMPOSIZIONE / MADE OF: PP
COLORI / COLOURS:

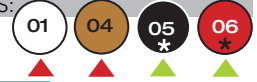

COD: SECTFF53

Misure esterne: 53 x 32,5 cm
Misure interne: 47 x 28 cm

External dimensions: 53 x 32,5 cm
Internal dimensions: 47 x 28 cm

* Colori in pronta consegna.
Per altri colori richiedere preventivo
*Ready for delivery colours.
Ask for a quote for other colours

VASSOIO PIZZERIA
Pizzeria tray



COMPOSIZIONE / MADE OF: PP
COLORI / COLOURS:



COD: SECTFF34

Misure esterne: 34,5 x 27 cm
Misure interne: 30,5 x 23 cm

External dimensions: 34,5 x 27 cm
Internal dimensions: 30,5 x 23 cm

* Colori in pronta consegna.
Per altri colori richiedere preventivo
*Ready for delivery colours.
Ask for a quote for other colours

VASSOIO FAST FOOD
Fast food tray



COMPOSIZIONE / MADE OF: PP
COLORI / COLOURS:

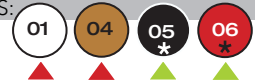

COD: SECTFF41

Misure esterne: 41,5 x 30,5 cm
Misure interne: 37,5 x 26,7 cm

External dimensions: 41,5 x 30,5 cm
Internal dimensions: 37,5 x 26,7 cm

* Colori in pronta consegna.
Per altri colori richiedere preventivo
*Ready for delivery colours.
Ask for a quote for other colours

VASSOIO SAGOMATO
Shaped tray



COMPOSIZIONE / MADE OF: PP
COLORI / COLOURS:



COD: SECTFFPG

Misure esterne: 53 x 32,5 cm
Misure interne: 47 x 28 cm

External dimensions: 53 x 32,5 cm
Internal dimensions: 47 x 28 cm

* Colori in pronta consegna.
Per altri colori richiedere preventivo
*Ready for delivery colours.
Ask for a quote for other colours

VASSOIO GASTRONORM CON PRESE LATERALI
Gastronorm tray with side sockets



COMPOSIZIONE / MADE OF: PP
COLORI / COLOURS:



COD: SECTFFMN

Misure esterne: 53 x 32,5 cm
Misure interne: 44,5 x 29,3 cm

External dimensions: 53 x 32,5 cm
Internal dimensions: 44,5 x 29,3 cm

* Colori in pronta consegna.
Per altri colori richiedere preventivo
*Ready for delivery colours.
Ask for a quote for other colours



VASCHEE SOVRAPPONIBILI

Stackable trays

Tutto quello che serve per la lavorazione delle materie prime e il trasporto dei prodotti. Anche questo settore cerca di intercettare tendenze e necessità del mercato seguendo gli input che si ricevono dai clienti.

All you need for processing raw materials and transporting products. This section responds to market trends and market needs according to our customers' inputs.



CASSETTE SOVRAPPONIBILI
Stackable boxes

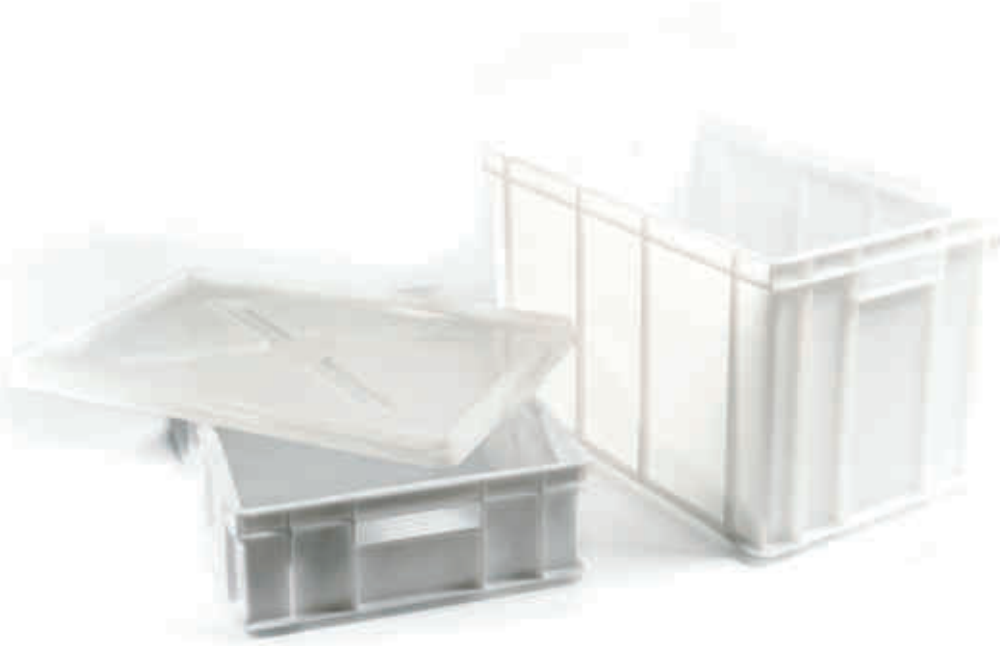

CASSETTA SOVRAPPONIBILE 60x40
Stackable box 60x40

- ▶ COD: SECSMP0701 D: 60 x 40 x 7 cm
- ▶ COD: SECSMP1001 D: 60 x 40 x 10 cm
- ▶ COD: SECSMP1301 D: 60 x 40 x 13 cm
- ▶ COD: SECSMP2001 D: 60 x 40 x 20 cm
- ▶ COD: SECSMP3201 D: 60 x 40 x 32 cm

CASSETTA SOVRAPPONIBILE 40x30
Stackable box 40x30

- ▶ COD: SECSMP1001 D: 40 x 30 x 10 cm
- ▶ COD: SECSMP2201 D: 40 x 30 x 22 cm

COPERCHI
Covers

- ▶ COD: SECP604001 D: 60 x 40 cm
- ▶ COD: SECP603001 D: 40 x 30 cm

CASSETTE FORATE SOVRAPPONIBILI
Stackable perforated boxes



CASSETTA FORATA
Perforated box

- ▶ COD: SECFMP1301 D: 60 x 40 x 13 cm
- ▶ COD: SECFMP4001 D: 72 x 36 x 47 cm

CARRELLO PORTACASSETTE CON RUOTE PIROETTANTI
Carrying trolley box with four rotating wheels



- ▶ COD: SEEPPN0206 D: 60 x 40 cm

CARRELLO PORTACASSETTE IN FILO METALLICO
Metal wire carrying trolley box with four rotating wheel



- ▶ COD: SEEPPN0112 D: 60 x 40 cm



COMPLEMENTI DA BANCO

Counter accessories: food tools

In plastica (melamina, policarbonato,...) e metallo (acciaio inox) tutti i monopezzi necessari per servire facilmente in tutti i contesti.

All one-piece products made of plastic (melamine, polycarbonate ...) and metal (stainless steel) to serve in any situation.



CUCCHIAIO
Spoon

COLORI:
COLOURS:



COD: SEC BSP01 L :23,5 cm

COMPOSIZIONE: SAN
MADE OF: SAN

CUCCHIAIO PER ANTIPASTI
Appetizer spoon

COLORI:
COLOURS:



COD: SEC BSP02 L :26 cm

COMPOSIZIONE: SAN
MADE OF: SAN

PALETTA
Scoop

COLORI:
COLOURS:



COD: SEC BSP03 L :25 cm

COD: SEC BSP04 L :31 cm

COMPOSIZIONE: SAN
MADE OF: SAN

PINZA
Tongs

COLORI:
COLOURS:



COD: SEC BSP012 L :24 cm

COMPOSIZIONE: SAN
MADE OF: SAN

PINZA PER SPAGHETTI
Spaghetti clamp



▶ COD: SEC BL10331 L: 16 cm

COMPOSIZIONE: STS
MADE OF: STS

PINZA PER IL PANE
Bread tongs



▶ COD: SEC BL10431 L: 23 cm

COMPOSIZIONE: STS
MADE OF: STS

PALETTA PER PASTICCERIA CON LAMA SEGHETTATA
Pastry scoop with serrated blade



▶ COD: SEC BPM3731 L: 29,5 cm

COMPOSIZIONE: STS
MADE OF: STS

SCHIUMAROLA
Skimmer



▶ COD: SEC B251131 L: 38,5 cm

COMPOSIZIONE: STS
MADE OF: STS

PINA PER SERVIRE
Serving tongs



▶ COD: SEC BL10531 L: 24 cm

COMPOSIZIONE: STS
MADE OF: STS

CUCCHIAIO PER SOTTOLIO E SPAGHETTI
Spaghetti spoon



▶ COD: SEC B167331 L: 32,5 cm

COMPOSIZIONE: STS
MADE OF: STS

PINZA PER CARNI E VEGETALI
Meat tongs



► COD: SECBL30931 L: 23,5 cm

COMPOSIZIONE: STS
MADE OF: STS

CUCCHIAIONE
Large spoon



► COD: SECBM25631 L: 48 cm

COMPOSIZIONE: STS
MADE OF: STS

MESTOLO Ø 90 MM
Ø 90 mm ladle



► COD: SECB500931 L: 36 cm

COMPOSIZIONE: STS
MADE OF: STS

PINZA PER AFFETTATI
Cold cuts tongs



► COD: SECBL11931 L: 10 cm

COMPOSIZIONE: STS
MADE OF: STS

PINZA PER SOTTOLO E SOTTACETO
Salad tongs



► COD: SECB811931 L: 21,5 cm

COMPOSIZIONE: STS
MADE OF: STS

CUCCHIAIONE MULTIUSO FORATO
Large multipurpose holed spoon



► COD: SECB102F31 L: 30 cm

COMPOSIZIONE: STS
MADE OF: STS

PALETTA PER FRITTI
Scoop for fried food



► COD: SECB270931 L: 32 cm

COMPOSIZIONE: STS
MADE OF: STS

PINZA PER DOLCI
Cake tongs



► COD: SECB811131 L: 20 cm

COMPOSIZIONE: STS
MADE OF: STS

PINZA PER CARNI E VEGETALI
Salad and meat tongs



► COD: SECBL39931 L: 25 cm

COMPOSIZIONE: STS
MADE OF: STS

PALETTA CON FORI
Scoop with holes



► COD: SECB270231 L: 48 cm

COMPOSIZIONE: STS
MADE OF: STS



DECORAZIONI DA BANCO

Stand decorations

Per dare vivacità e colore al bancone in questa sezione ci sono diversi prodotti in plastica molto ben realizzati che consentono infinite combinazioni.

In this section there are several very well made plastic products that allow endless combinations to give brightness and colour to your stand.



GHIRLANDA DI PREZZEMOLO
Garland of parsley



▶ COD: SECBPS10 L: 90 cm
COMPOSIZIONE: PP
MADE OF: PP

GHIRLANDA DI EDERA
Garland of ivy



▶ COD: SECB1037 L: 180 cm
COMPOSIZIONE: PP
MADE OF: PP

VITE CON GRAPPOLI DI UVA NERA
Black grapes



▶ COD: SECBSB21 L: 185 cm
COMPOSIZIONE: PP
MADE OF: PP

GHIRLANDA AUTUNNALE
Fall garland



▶ COD: SECB1036 L: 185 cm
COMPOSIZIONE: PP
MADE OF: PP

DECORAZIONE DA BANCO CON PIANTE VERDI
Green plant stand decoration

COLORI:

05 01



▶ COD: SECBD032 D: 75 x 8 cm
COMPOSIZIONE: PP
MADE OF: PP

DECORAZIONE DA BANCO CON PIANTE ROSSO/VERDI
Green/red plant stand decoration

COLORI:

05 01



▶ COD: SECBDR32 D: 75 x 8 cm
COMPOSIZIONE: PP
MADE OF: PP

DECORAZIONE DA BANCO CON PIANTE VERDE CHIARO
Light green plant stand decoration

COLORI:

05 01



▶ COD: SECBDG30 D: 75 x 8 cm
COMPOSIZIONE: PP
MADE OF: PP

RAFFIA
Raffia

COLORE:

98



▶ COD: SEACYT1K98 1 Kg

JUTA
Jute



▶ COD: SEACTX5098
D: 5000 X 100 H cm

TAPPETO IN ERBA SINTETICA
Synthetic grass food carpet



▶ COD: SEBCP8107
D: 180 X 90 cm

TAPPETO ANTISCIVOLO
Non-slip mat

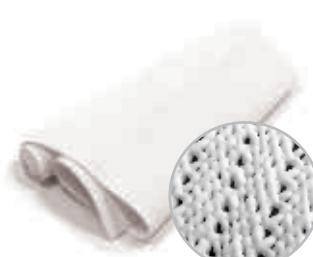

▶ COD: SETPASCC01
D: 43 x 150 cm

TAPPETO SPUGNOSO
Spongy mat



▶ COD: SETPSPCC05
D: 65 x 100 cm



FINTO FOOD

Food-like

Questa categoria di prodotti è perfetta per creare composizioni, bacheche, allestimenti e qualsiasi altra idea creativa che contenga frutta artificiale. Disponiamo di una gran varietà di frutta e verdura finta e ogni prodotto è caratterizzato da una perfezione quasi ingannevole. Con questi prodotti si possono fare composizioni di frutta matura che sembra appena colta.

This product category is perfect for creating compositions, boards, displays and any other creative idea associated to the artificial fruit.

We have a wide variety of fake fruit and vegetable and each product is characterized by an almost deceptive perfection.

With these products you can make compositions of ripe fruit that looks like freshly picked.



SCOPRI LA GAMMA COMPLETA SUL SITO
FIND OUT THE COMPLETE RANGE ON WEBSITE

ALBICOCCA
Apricot



▶ COD: SECBFRAB99
COMPOSIZIONE: PP
MADE OF: PP

PEPERONE
Pepper



▶ COD: SECBFRPP99
COMPOSIZIONE: PP
MADE OF: PP

POMPELMO
Grapefruit



▶ COD: SECBFRPM99
COMPOSIZIONE: PP
MADE OF: PP

RADICCHIO
Reddish



▶ COD: SECBFRRD99
COMPOSIZIONE: PP
MADE OF: PP

FRAGOLA
Strawberry



▶ COD: SECBFRFA99
COMPOSIZIONE: PP
MADE OF: PP

LIMONE
Lemon



▶ COD: SECBFRLM99
COMPOSIZIONE: PP
MADE OF: PP

KIWI
Kiwi



▶ COD: SECBFRKW99
COMPOSIZIONE: PP
MADE OF: PP

ANANAS
Pineapple



Ananas intera
Complete pineapple
▶ COD: SECBFRAA98
Ananas a metà
Half pineapple
▶ COD: SECBFRMA98
COMPOSIZIONE: PP
MADE OF: PP

MELA
Apple



▶ COD: SECBFRML99
COMPOSIZIONE: PP
MADE OF: PP

BANANA
Banana



▶ COD: SECBFRBN99
COMPOSIZIONE: PP
MADE OF: PP

ARAGOSTA
Lobster



▶ COD: SECBITAA99
COMPOSIZIONE: PP
MADE OF: PP

PARMIGIANO REGGIANO
Parmesan Cheese



▶ COD: SECBFOPR99
COMPOSIZIONE: PP
MADE OF: PP

GRANCHIO
Crab



▶ COD: SECBITGA99
COMPOSIZIONE: PP
MADE OF: PP

PROSCIUTTO DI PARMA
Parma ham



▶ COD: SECBSAP99
COMPOSIZIONE: PP
MADE OF: PP

PESCE
Fish



▶ COD: SECBITP199
COMPOSIZIONE: PP
MADE OF: PP

PANE
Bread



▶ COD: SECBBRPN99
COMPOSIZIONE: PP
MADE OF: PP

PESCE
Fish



▶ COD: SECBITP299
COMPOSIZIONE: PP
MADE OF: PP

BAGUETTE
Baguette



▶ COD: SECBBRBG99
COMPOSIZIONE: PP
MADE OF: PP

PESCE
Fish



▶ COD: SECBITP399
COMPOSIZIONE: PP
MADE OF: PP

UOVA
Eggs



▶ COD: SECBEGOE99
COMPOSIZIONE: PP
MADE OF: PP



PRICE
Communication



Comunicazione **PREZZO**

OFFERTA

0,85

ER
SALATI

CRACKERS



SMART CARD PRINTER

Il nostro sistema di stampa easy card nasce per facilitare la gestione della comunicazione di prezzo su card. Semplice e affidabile questo sistema è stato studiato in ogni aspetto. Le stampanti sono professionali, a caricamento automatico e consentono la stampa fronte-retro. Il software, progettato in esclusiva per i nostri clienti, permette la creazione di segnaprezzi e la modifica dei cartellini in tempi record. È possibile acquistare le card nere o bianche in pratici kit per ottimizzare i costi. Con le stampanti **Magicard 300** e **Pronto** si può stampare in bianco e nero o a colori. È disponibile una vasta gamma di distintivi intercambiabili per personalizzare ogni categoria di prodotto con pratici supporti in plastica.

A pagina 59 trovate la descrizione di un software di nostra progettazione che può aiutare a realizzare grafiche molto originali e professionali.

Our easy card printing system has been made to facilitate the management of price communication by cards. This system is simple and reliable, it has been studied in every aspect. The printers are professional, self-loading and allow double-sided printing. The software allows the creation of price tags and the fast modification of the cards. You can buy black or white cards in practical kits to optimize costs. With Magicard 300 and Pronto printers you can have black, white or coloured prints. A wide range of available interchangeable badges make each product category customizable using practical plastic supports.

On page 59 you will find a description of a software we designed that can help you create very original and professional graphics.



STAMPANTE PROFESSIONALE MAGICARD 300

MagiCard 300 professional printer



COD: CPSCMGC300

Robusta, resistente e affidabile e dotata di Digital shredding (TM), MagiCard 300 è perfetta per scuole, università e aziende di medie dimensioni che stampano fino a 10.000 carte all'anno. Quando si tratta di stampare carte sicure e affidabili, puoi affidarti a MagiCard 300.

Strong, durable and reliable, MagiCard 300 is equipped with Digital shredding™. It is perfect for schools, colleges and medium sized businesses which print up to 10,000 cards per year. You can trust MagiCard 300 for safe and reliable cards



Peso Weight
4.98kg

Funzionamento Operation

Per funzionare rapidamente e facilmente, MagiCard 300 si integra via USB, riducendo al minimo i tempi di installazione e richiedendo poche conoscenze tecniche.

MagiCard 300 can be easily and quickly ready to work via USB, reducing setup time and requiring little technical knowledge

Sicurezza Safety

MagiCard 300 sfrutta la tecnologia Digital shredding™, il che significa che una volta che le informazioni sono state utilizzate per un lavoro di stampa, sono frammentate e disperse, rendendole irrecuperabili.

MagiCard 300 uses Digital shredding™ technology which destroys any printing information making it unrecoverable.

Garanzia Warranty

MagiCard 300 è coperto da una garanzia limitata di 3 anni che include la copertura della testina di stampa** e l'accesso diretto al team di supporto tecnico globale di MagiCard. Al momento dell'acquisto è disponibile un'ulteriore garanzia di un anno.

MagiCard 300 has a 3 year limited warranty which covers its printhead and grants direct access to the global MagiCard technical support team. A further one-year warranty is available when purchasing MagiCard 300.

Qualità Quality

MagiCard 300 offre un'ampia gamma di colori e stampe a 300 x 300 dpi, ideali per fotografie su carte d'identità e una rappresentazione più accurata dei loghi aziendali e di altre immagini.

MagiCard 300 offers a wide range of colours and 300 x 300 dpi printings – fit for ID card photos and more accurate performances of company logos or of other images.

Driver Driver

Windows, Mac OS
Windows, Mac OS

Aggiornamenti Upgrades

MagiCard 300 è facile da aggiornare con le ultime funzionalità e correzioni man mano che vengono resi disponibili.

MagiCard 300 is easy to upgrade with the newest functions and available revisions.

Alimentazione Elettrica Power supply

Multistandard

Dimensioni Dimensions

21,5 x 24,2 x 40,8 cm

Velocità di stampa Printing speed

Ogni carta a colori su un solo lato, può essere stampata in meno di 23 secondi mentre una versione solo resina richiede meno di 6 secondi.

Each colour card can be printed in less than 23 seconds on only one side, while for a resin-only version it takes less than 6 seconds.

Resistenza Resistance

Realizzato con materiali appositamente progettati ad alte prestazioni e componenti avanzati

Made of advanced and high performance material components specially designed.

Efficienza Efficiency

Il firmware analizza i colori inviati e il tipo di pellicola montato e stampa in modo che i pannelli di pellicola non vengano sprecati.

The firmware analyses all the sent colours and the film type used so that it doesn't waste film panels printing them in sequence.

Tipo di stampa Type of printing

Stampa in serie con l'alimentatore intercambiabile da 100 carte o stampa carte singole o riscrivibili con l'alimentatore manuale.

Batch print with 100 cards interchangeable power supply or single cards or rewritable cards by hand supply.

STAMPANTE PROFESSIONALE PRONTO

Pronto professional printer

COD: CPSCPC00

La stampante compatta e portatile per la stampa delle vostre carte a colori.

Cosa puoi chiedere di più ad una stampante di questo tipo, se non che stampi bene, sia veloce, affidabile e facile da utilizzare?

Bene, Pronto ha tutte queste caratteristiche. È anche economica, grazie all'economizzatore di stampa sui nastri monocromatici consumerete solo l'effettiva porzione di nastro necessaria alla stampa, di conseguenza l'autonomia dei nastri sarà la più elevata possibile.

The compact and portable printer for printing your cards in colour.

What would you like your printer to do? It should print well, be fast, reliable and easy to use! Well, Pronto is the right choice then. It is also cheap. Thanks to the print economizer on monochrome tapes you will only use the actual portion of tape required for printing, that's why the tapes autonomy will be as high as possible.



Peso Weight

4,4 kg

Sicurezza Safety

Possibilità di stampa di filigrana virtuale e hot stamping hologram durante il processo di stampa, con immagini prestabilite, senza utilizzare nastri di stampa aggiuntivi.

Possibility of printing a virtual watermark and hot hologram stamping during the printing process, with predetermined images, without using additional printing tapes.

Garanzia Warranty

Su tutte le parti ad esclusione delle parti di consumo (nastri, card e testine di stampa).

By law on all parts except consumables, such as tapes, cards and printheads.

Interfaccia Interface

USB 1.1 – compatibile USB 2.0

USB 1.1 - USB 2.0 compatible

Driver Driver

Windows 2000, 2003 Server, XP, Vista, Seven

Windows 2000, 2003 Server, XP, Vista, Seven

Alimentazione card Power supply card

Manuale.

Manual feeding.

Alimentazione Elettrica Power supply

Multistandard

Dimensioni Dimensions

27 cm x 21,5 cm x 23,3 cm

Temperatura di esercizio Operating temperature

Da 10 a 30 gradi centigradi.

30 centigrade degrees.

Velocità di stampa Printing speed

A colori 35 secondi per card bordo-bordo, in monocromatico 7 secondi per card.

35 seconds per colour edge-edge cards, 7 seconds per monochrome cards.

Tipologia di carte accettate Types of cards accepted

ISO standard CR 80 in PVC spessore suggerito da 0,51 mm a 1,02 mm, altri spessori da testare. Stampa su carte bianche, colorate e preprintate.

ISO standard CR 80 in PVC suggested thickness from 0.51 mm to 1.02 mm, other thicknesses to be tested. Print on white, coloured and preprinted papers.

Kit di pulizia Cleaning kit

Composto da carte di pulizia e in funzione della necessità penna di pulizia testina.

Made of cleaning papers and head cleaning pen depending on the needs .

Rulli di pulizia Cleaning rollers

Inseriti in ogni nastro di stampa o acquistabili in kit da 5.

Added in each printing tape or to be purchased in kits of 5.



SOFTWARE STAMPA CARD

Card print software

Le nostre stampanti per CARD possono essere usate creando le proprie grafiche con qualsiasi SW.

Un semplice programma di testo (come quelli che sono già disponibili nel corredo SW di base di qualsiasi PC o tablet) può permettere di realizzare stampe personalizzate e accattivanti.

Ovviamente con programmi dedicati alla grafica si possono ottenere risultati migliori e per facilitare l'utilizzo di quest'ultimi ne abbiamo progettato uno specifico per queste stampanti.

Per utilizzarlo è sufficiente collegarsi ad un sito WEB tramite una passw che renderà sicuro l'accesso.

Saranno disponibili 10 o più modelli (pensati per diverse realtà commerciali) che possono essere utilizzati in modo estremamente flessibile (le combinazioni ipotetiche sono migliaia) per rendere unica la vostra CARD.

Con questo software si potranno anche gestire le promozioni in maniera estremamente veloce ed efficace. Sempre all'interno del sito si potranno scegliere le opzioni di stampa e memorizzare in un'area riservata e protetta le grafiche definite in modo da poterle utilizzare in seguito. Uno strumento efficace che completa la nostra offerta di accessori per le stampanti per CARD. Su richiesta e preventivo si possono inserire modelli disegnati per uno specifico utilizzatore e che potranno essere usati solo da quest'ultimo.



Our CARD printers can be used by creating your own graphics with any SW.

A simple text program (such as those that are already available in the basic SW kit of any PC or tablet) can allow you to define customized and eye-catching prints.

Obviously with programs dedicated to graphics you can get better results and to facilitate the use of the latter we have designed a specific one for these printers.

To use it, it is sufficient to connect to a WEB site through a pass that will make access secure.

10 or more models will be available (designed for different commercial realities) that can be used in an extremely flexible way (there are thousands of hypothetical combinations) to make your CARD unique.

With this software you can also manage promotions in an extremely fast and effective way.

Always within the site you can choose the print options and store the defined graphics in a reserved and protected area so that you can use them later.

An effective tool that completes our range of accessories for CARD printers. Upon request and estimate, models designed for a specific user can be inserted and can be used only by the latter.

RIBBON

Ribbon

Grazie ai nostri speciali ribbon otterrai la massima qualità di stampa, alta resistenza antigraffio e possibilità di sovrastampare. Resistenza all'acqua e alle variazioni di temperatura.

Thanks to our special ribbons you will get the maximum print quality, high scratch resistance and the possibility to overprint. Resistance to water and temperature variations.

NASTRO NERO STAMPA CARD BIANCHE
Black ribbon white card print

COD: CPASCDRB05



Num. stampe 1000 (500 bifacciali)
1000 prints (500 double-sided prints)

NASTRO BIANCO STAMPA CARD NERE
White ribbon black card print

COD: CPASCDRB01



Num. stampe 1000 (500 bifacciali)
1000 prints (500 double-sided prints)

NASTRO A COLORI STAMPA CARD BIANCHE
CMYK ribbon white card print

COD: CPASCDRB99



Num. stampe 300 (150 bifacciali)
300 prints (150 double-sided prints)

KIT CARD BIANCHE
Black ribbon white card print

COD: CPASCDKC01



KIT CARD NERE
White ribbon black card print

COD: CPASCDKC05



KIT PULIZIA STAMPANTE
CMYK ribbon white card print

COD: CPASCDKTCL



DISTINTIVI

Distinctive

Visibilità immediata. Pratici da assemblare. Ordinabili in kit.
Materiale: PVC 0,5 mm.

Immediate visibility. Practical to assemble. Can be ordered in kit.
Material: PVC 0,5 mm



Possibilità di personalizzazione
Customization available

DISTINTIVI SUPERIORI

Upper legends

F.TO : 8,4 x 4 cm



COD: SUPSNOW



COD: SUPSOF



COD: SUPSOFF



COD: SUPSPDN



COD: SUPSBIO



COD: SUPSFRE



COD: SUPSVGN



COD: SUPSPES

DISTINTIVI LATERALI

Lateral distinctive

F.TO : 5,4 x 2 cm



COD: SUPLBIO



COD: SUPLVEG



COD: SUPLVGN



COD: SUPLSC



COD: SUPLOFF



COD: SUPLOFS



COD: SUPLPDN



COD: SUPLPC



COD: SUPLCC



COD: SUPLCAR



COD: SUPLCIT



COD: SUPLCD



COD: SUPLPK



COD: SUPLSG



COD: SUPLCON



COD: SUPLPT



ESEMPI DI DISTINTIVI SUPERIORI E LATERALI
Examples of upper and side badges

SUPPORTO H
H support



SUPPORTI IN PLASTICA E ADATTATORI
Plastic supports and adaptors

SUPPORTI CARD
Card supports



Supporto card a H. Materiale: POM.
Dimensione: 8,8 x 4,7 cm
H card support. Material: POM.
Dimensions: 8,8 x 4,7 cm

COD: CPPCT-BC



Adattatore verticale. Materiale: POM
Vertical adaptor. Material: POM

COD: CPAAMU64

05 01

Un vasto assortimento di supporti in plastica resistente e certificata dal design innovativo. Tante opzioni di assemblaggio per una comunicazione versatile ed efficace.

A wide range of resistant plastic supports guaranteed by an innovative design. Lots of assembly options for versatile and effective communication.



SEGNAPREZZO

Price tag

La produzione dei segnaprezzi può essere considerata uno dei nostri punti di forza. La continua evoluzione che abbiamo dedicato a questo settore garantisce oggi molteplici soluzioni anche personalizzabili. Nelle pagine seguenti sono elencate le tipologie che hanno riscosso maggior successo sul mercato.

The production of price tags can be considered one of our strengths. The continuous attention and the innovative processes we introduced into this sector paved the way to innumerable customizable solutions. The following pages list the most successful kinds now on sale.



SEGNAPREZZO SEMIERMETICO ETIJACK*Semi-hermetic Etijack price tag*

COD: CPSPJK20

COLORI :
COLOURS:

D: 10,6x 8 H cm

Segnaprezzo semiermetico ETI JACK con vetrino ad effetto lente lavabile in lavastoviglie Temp. Max 70°C. Materiale: ABS + PMMA. Confezione da 25 pezzi con adattatori piani.

ETI JACK semi hermetic price tag with effect glass small lens, dishwasher safe. Max temp.70 degrees. Material: ABS + PMMA. 25 items packaging with flat adaptors.

SUPPLEMENTI E ACCESSORI PROMOZIONALI PER ETIJACK*Etijack advertising accessories*COLORI :
COLOURS:

COD: CPSPJK30

COD: CPSPJK31

COD: CPSPJK3206

COD: CPSPJBLD

COD: CPSPLR01



Kit da 25 pz
(supporto+ cursore)
25 pcs kit
(holder+cursor)



Kit da 25 pz
(supporto+ cursore)
25 pcs kit
(holder+cursor)



Kit da 25 pz
(supporto+ cursore)
25 pcs kit
(holder+cursor)



25 Label drops per settori
merceologici e loghi
aziendali. Materiale: ABS
25 Label drops for product
categories and business
logos. Material: ABS



Etichette adesive resinare
personalizzate
Fogli da 25 etichette
Customized resin adhesive
labels
Sheets of 25 labels

SEGNAPREZZO ERMETICO ETISABY DOPPIO UTILIZZO*Etisaby hermetic double-sided price tag*

COD: CPSPSB20



COD: CPSPSB20



Primo utilizzo con numeri ad inserimento. Lavabile in lavastoviglie. Max 70°C. Materiale: ABS+PMMA. Confezione da 25 pz con adattatori.

First side with numbers to be inserted. Dishwasher safe. Max 70°C. Material: ABS+PMMA. 25 items package with adaptors.

Secondo utilizzo per cartoncino pretagliato. Lavabile in lavastoviglie. Max 70°C. Materiale: ABS+PMMA. Confez. da 25 pz con adattatori.

Second side for pre-cut small cardboard. Dishwasher safe. Max 70°C. Material: ABS+PMMA. 25 items package with adaptors.

SUPPLEMENTI E ACCESSORI PROMOZIONALI PER ETISABY*Etisaby advertising accessories*COLORI :
COLOURS:

COD: CPSPSB3006

COD: CPSPSB3106

COD: CPSPSB3306

COD: CPSPJBLD

COD: CPSPLR01



Kit da 25 pz
(supporto+ cursore)
25 pcs kit
(holder+cursor)



Kit da 25 pz
(supporto+ cursore)
25 pcs kit
(holder+cursor)



Kit da 25 pz
(supporto+ cursore)
25 pcs kit
(holder+cursor)



25 Label drops per settori
merceologici e loghi
aziendali. Materiale: ABS
25 Label drops for product
categories and business
logos. Material: ABS



Etichette adesive resinare
personalizzate
Fogli da 25 etichette
Customized resin adhesive
labels
Sheets of 25 labels

SEGNAPREZZO MINITASCA

Minitasca price tag

COD: CPSPMT2008



D: 9,8 X 6,8 H cm

Segnaprezzo porta etichette trasparente MINITASCA. Retro trasparente per visualizzare i riferimenti agli operatori. Materiale: PP. Confezione 25 pezzi con adattatori verticali.

MINITASCA transparent price tag holder. Transparent back side to display indications to operators. Material: PP. 25 pcs package with vertical adapters.

SUPPLEMENTI E ACCESSORI PROMOZIONALI PER MINITASCA

Minitasca advertising accessories

COD: CPSPMT30



Dimensioni 9,8 x 3,2 cm.
25 supplementi promozionali
Size 9,8 x 3,2 cm.
25 advertising items

COD: CPSPMT31



Dimensioni 9,8 x 3,2 cm.
25 supplementi promozionali
Size 9,8 x 3,2 cm.
25 advertising items

COD: CPSPMT34



Dimensioni 9,8 x 3,2 cm.
25 supplementi promozionali
Size 9,8 x 3,2 cm.
25 advertising items

SEGNAPREZZO TASCA

Tasca price tag

COD: CPSPTA2008



D: 11,5 X 8,5 H cm

Segnaprezzo porta etichette trasparente TASCA. Retro trasparente per visualizzare i riferimenti agli operatori. Materiale: PP. Confezione 25 pezzi con adattatori verticali.

TASCA transparent price tag holder. Transparent back side to show indications to operators. Material: PP. 25 pcs package with vertical adapters.

SUPPLEMENTI E ACCESSORI PROMOZIONALI PER TASCA

Tasca advertising accessories

COD: CPSPTA30



Dimensioni 11 x 4,5 cm.
25 supplementi promozionali
Size 11 x 4,5 cm.
25 advertising items

COD: CPSPTA31



Dimensioni 11 x 4,5 cm.
25 supplementi promozionali
Size 11 x 4,5 cm.
25 advertising items

COD: CPSPTA34



Dimensioni 11 x 4,5 cm.
25 supplementi promozionali
Size 11 x 4,5 cm.
25 advertising items

SUPPORTO SEGNAPREZZO IN PLEXIGLASS

Perspex price tag holder

Porta prezzo per vasca surgelati con segnaprezzo H 39 Materiale: PMMA spessore 3 mm
Per altri formati richiedere preventivo.

Price holder for frozen food container with 39 h. price tag Material: 3 mm thick PMMA.
Ask for a quote for other sizes



COD: CPSPVF3508

COD: CPSPVF4508

COD: CPSPVF5508



Dimensioni: 8,5 x 35 H cm.
Size 8,5 x 35 H cm.



Dimensioni: 8,5 x 45 H cm.
Size 8,5 x 45 H cm.



Dimensioni: 8,5 x 55 H cm.
Size 8,5 x 55 H cm.



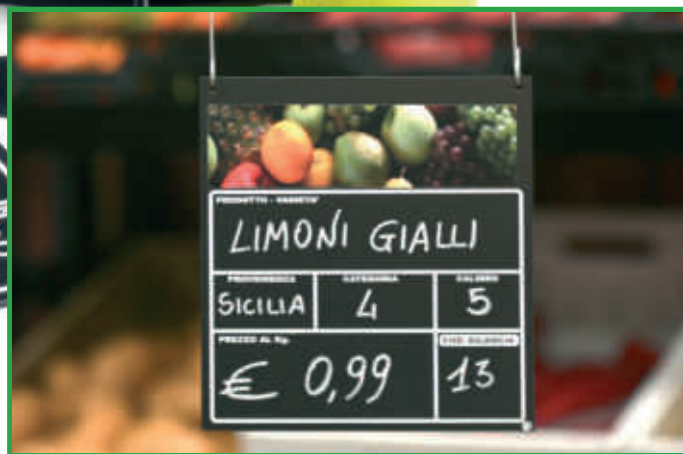

SEGNAPREZZO CANCELLABILI

Eraseable price tag

I marcatori proposti insieme ai nostri segnaprezzi sono in gesso liquido o permanenti a base acqua. Atossici.

Markers proposed together with our price tags are in liquid chalk or water-based permanent. Non-toxic.



SEGNAPREZZO CANCELLABILE SU PVC

SEGNAPREZZO CANCELLABILE PVC NEUTRO

Neutral PVC erasable price tag



COD: CPLA010105

COD: CPLAWD0101

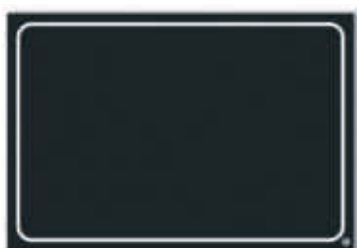

Dimensioni: 10 x 7 H cm

Segnaprezzo cancellabile neutro. Materiale: PVC nero spessore 0,5 mm. Confezione da 25 pezzi
Neutral erasable price tag, Black. Material: 0.5mm thick black PVC 25 pcs package.

Dimensioni: 10 x 7 H cm

Segnaprezzo cancellabile bordo legno. Materiale: PVC nero Spessore 0,5 mm. Confezione da 25 pezzi
Neutral erasable price tag with wooden frame. Material: 0.5mm thick black PVC. 25 pcs package

SEGNAPREZZO CANCELLABILE PESCHERIA

Fishmonger erasable price tag



COD: CPLA110101

COD: CPLA120102



Dimensioni: 15 x 10 H cm

Segnaprezzo cancellabile per pescheria Tracciabilità prodotto. Materiale: PVC bianco spessore 0,7mm .Confezione da 25 pezzi.
Fishmonger erasable price tag. Made of: 0.7 mm white PVC. 25 pcs package

Dimensioni: 15 x 10 H cm

Segnaprezzo cancellabile per pescheria Tracciabilità prodotto. Materiale: PVC blu spessore 0,7 mm. Confezione da 25 pezzi.
Fishmonger erasable price tag. Made of: 0.7mm thick blue PVC. 25 pcs package.

SEGNAPREZZO CANCELLABILE ORTOFRUTTA

Fruit and vegetable erasable price tag



MONOFACCIALE COD: CPLAMFA305

BIFACCIALE COD: CPLABFA305



D: 29,7 x 42 H cm

D: 29,7 x 42 H m

Segnaprezzo cancellabile serie lavagna ortofrutta A3 verticale. Per cornici con tracciabilità prodotto. Materiale: PVC nero spessore 0,5 mm. Confezione da 10 pezzi. 1 Pennarello bianco

A3 vertical fruit and vegetable blackboard erasable price tag series with frames for product traceability. Made of: 0,5mm thick black PVC. 10 pcs package. 1 white marker pen

SEGNAPREZZO CANCELLABILI OFFERTA

Erasable price tag for special offers

ORIZZONTALE MONOFACCIALE COD: CPLAOFH405
Horizontal and single-sided

VERTICALE MONOFACCIALE COD: CPLAOFV405
Vertical single-sided

D: 29,7 x 21 H cm

D: 21 x 29,7 H cm

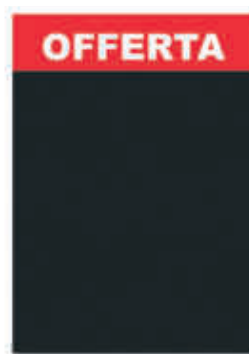

ORIZZONTALE BIFACCIALE COD: CPLABFH405

VERTICALE BIFACCIALE COD: CPLABFV405

Segnaprezzo cancellabile ortofrutta orizzontale "Offerta". A4 per cornici, tracciabilità prodotto. Materiale: PVC nero spessore 0,5 mm. Confezione da 10 pezzi. 1 Pennarello bianco

Erasable horizontal price tag for special offers. A4 frames for fruit and vegetable traceability. Made of: 0,5mm thick black PVC. 10 pcs package. 1 white marker pen

Segnaprezzo cancellabile ortofrutta verticale "Offerta". A4 per cornici, tracciabilità prodotto. Materiale: PVC nero spessore 0,5 mm. Confezione da 10 pezzi. 1 Pennarello bianco

Erasable vertical price tag for special offers. A4 frames for fruit and vegetable traceability. Made of: 0,5mm thick black PVC. 10 pcs package. 1 white marker pen

SEGNAPREZZO CANCELLABILE PASTICCERIA

Erasable pastry price tag



COD: CPLAP20101

COD: CPLAP30101



D: 9 x 6 H cm

Segnaprezzo pasticceria da abbinare con gli accessori appositi presenti nella sezione "accessori per segnaprezzo". Materiale: PVC spessore 0,7 mm. Senza nessun attacco. Confezione da 25 pezzi.

Pastry price tag to be combined with the appropriate accessories in the "price tag accessories" section. Made of: 0,7 mm thick PVC. Without holder. Pack of 25 pcs.



D: 8 x 9 H cm

Segnaprezzo pasticceria da abbinare con gli accessori appositi presenti nella sezione "accessori per segnaprezzo". Materiale: PVC spessore 0,7 mm. Senza nessun attacco. Confezione da 25 pezzi.

Pastry price tag to be combined with the appropriate accessories in the "price tag accessories" section. Made of: 0,7 mm thick PVC. Without holder. Pack of 25 pcs.

COD: CPLAP40101

COD: CPLA50101



D: 9 x 6 H cm

Segnaprezzo pasticceria. Materiale: PVC spessore 0,7 mm. Confezione da 25 pezzi.

Pastry price tag. Made of: 0,7 mm thick PVC. Without holder. Pack of 25 pcs.



D: 8 x 9 H cm

Segnaprezzo da appoggio. Materiale: PVC spessore 0,7 mm. Confezione da 25 pezzi.

Price holder tag. Made of: 0,7 mm thick PVC. Pack of 25 pcs.

SEGNAPREZZO CANCELLABILE IN PPL

SEGNAPREZZO CANCELLABILE PPL

PPL erasable price tag

COD: CPLAPL20

COLORI :
COLOURS:



D: 12 x 8 H cm

Segnaprezzo cancellabile serie lavagna PPL, fustellato e stampato in serigrafia. Materiale: PPL lineare spessore 1,2 mm. Con inserto a "C" A7
PPL blackboard die-cut and screen printed erasable price tag series. Made of: 1.2mm thick linear PP. With an A7 "C"-shaped accessory

SEGNAPREZZO CANCELLABILE PPL PESCHERIA

PPL erasable price tag for fishmonger's

COD: CPLAPP2005



D: 15 x 11 H cm

Segnaprezzo cancellabile serie PPL tracciabilità pescheria. Materiale: PPL lineare spessore 1,2 mm Con inserto a "C" A6
PPL traceability product erasable price tag for fish. Made of: 1.2mm thick linear PP. With an A6 "C"-shaped accessory

SEGNAPREZZO CANCELLABILE ORTOFRUTTA

PPL erasable for fruits and vegetables price tag

COD: CPLA1F2005

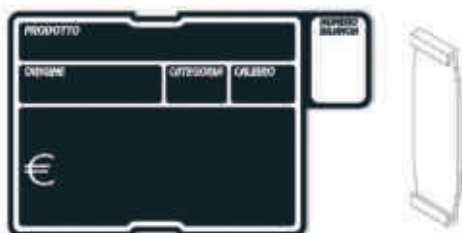

D: 18 x 11 H cm

Segnaprezzo cancellabile serie lavagna PPL tracciabilità ortofrutta 1, codice bilancia esterno. Materiale: PP lineare spessore 1,2 mm.
Con inserto a "C" A6
PPL product traceability fruit and vegetables erasable blackboard price tag series with external scales code Made of: 1.2 mm thick linear PP With an A6 "C"-shaped accessory

COMBINAZIONI PER SEGNAPREZZO ORTOFRUTTA

For fruits and vegetables price tag kits

COD: CPLA1F0605

COD: CPLA1F3205

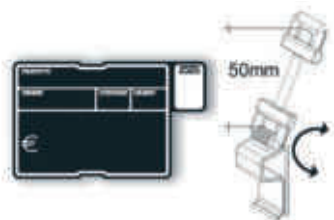

Kit da 25 pz. + 1 pennarello bianco
(segnaprezzi+mollette)
Kit of 25 pcs + 1 white marker (price tags + clips)



Kit da 25 pz. + 1 pennarello bianco
(segnaprezzi+mollette)
Kit of 25 pcs + 1 white marker (price tags + clips)

SEGNAPREZZO CANCELLABILE ORTOFRUTTA

PPL Erasable fruit and vegetable price tag

COD: CPLA2F2005



D: 15 x 11 H cm

Segnaprezzo cancellabile PPL tracciabilità ortofrutta 2, codice bilancia interno. Materiale: PP lineare spessore 1,2 mm. Con inserto a "C" A6
 PPL product traceability erasable fruit and vegetables price tag with internal scales code. Made of: 1.2 mm thick linear PP. With an A6 "C"-shaped accessory

COMBINAZIONI PER SEGNAPREZZO ORTOFRUTTA

Fruits and vegetable price tag kits

COD: CPLA2F0605

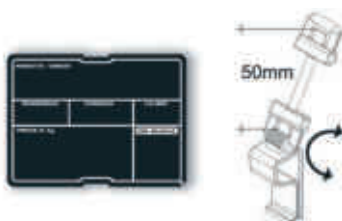

Kit da 25 pz. + 1 pennarello bianco (segnaprezzi+mollette)
 Kit of 25 pcs + 1 white marker (price tags + clips)

COD: CPLA2F3205

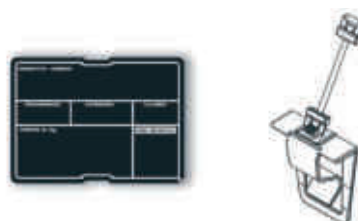

Kit da 25 pz. + 1 pennarello bianco (segnaprezzi+mollette)
 Kit of 25 pcs + 1 white marker (price tags + clips)

SEGNAPREZZO CANCELLABILE ORTOFRUTTA

PPL erasable fruit and vegetable price tag

COD: CPLA3F2005



D: 15 x 11 H cm

Segnaprezzo cancellabile PPL tracciabilità ortofrutta 3, codice bilancia interno. Materiale: PPL lineare spessore 1,2 mm. Con inserto a "C" A6
 PPL product traceability erasable fruit and vegetables price tag with internal scales code. Made of: 1.2 mm thick linear PP. With an A6 "C"-shaped accessory

COMBINAZIONI PER SEGNAPREZZO ORTOFRUTTA

Fruit and vegetable price tag kits

COD: CPLA3F0605

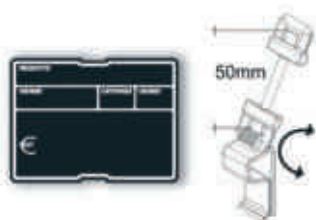

Kit da 25 pz. + 1 pennarello bianco (segnaprezzi+mollette)
 Kit of 25 pcs + 1 white marker (price tags + pressure clips)

COD: CPLA3F3205



Kit da 25 pz. + 1 pennarello bianco (segnaprezzi+mollette)
 Kit of 25 pcs + 1 white marker (price tags + clips)

SEGNAPREZZO CANCELLABILE IN FOREX

SEGNAPREZZO PER ORTOFRUTTA A6

A6 forex erasable price tag for fruits and vegetables

COD: CPLAF60105



D: 14,8 x 10,5 H cm

Segnaprezzo cancellabile serie lavagna in FOREX per ortofrutta con tracciabilità prodotto. Materiale: FOREX espanso spessore 3mm. Confezione da 25 pezzi.

Product traceability forex erasable fruit-and-vegetable blackboard price tag series. Made of :3 mm thick expanded FOREX. 25 pcs package.

COMBINAZIONI SEGNAPREZZO PER ORTOFRUTTA A6

A6 price tag kits for fruits and vegetables

COD: CPLAF60605

COD: CPLAF63005

COD: CPLAF63105



Kit da 25 pz + 1 pennarello bianco (segnaprezzi+mollette da 50 mm+ adattatori)

Kit of 25 pcs + 1 white marker (price tags + 50 mm pressure clips + adapters)



Kit da 25 pz + 1 pennarello bianco (segnaprezzi+pinze da 50 mm)

Kit of 25 pcs + 1 white marker (price tags + 50 mm clips)



Kit da 25 pz + 1 pennarello bianco (segnaprezzi+pinze da 150 mm)

Kit of 25 pcs + 1 white marker (price tags + 150 mm clips)

SEGNAPREZZO CANCELLABILE FOREX PER ORTOFRUTTA A5

A5 forex erasable price tag for fruits and vegetables

COD: CPLAF50105



D: 21 x 14,8 H cm

Segnaprezzo cancellabile serie lavagna in FOREX per ortofrutta con tracciabilità prodotto. Materiale: FOREX espanso spessore 3mm. Confezione da 25 pezzi.

Product traceability forex fruit-and-vegetable erasable blackboard series price tag. Made of:3mm thick expanded FOREX. 25 pcs package.

COMBINAZIONI SEGNAPREZZO PER ORTOFRUTTA A5

A5 price tag kits for fruits and vegetables

COD: CPLAF50605

COD: CPLAF53005

COD: CPLAF53105



Kit da 25 pz + 1 pennarello bianco (segnaprezzi+mollette da 50 mm+ adattatori)

Kit of 25 pcs + 1 white marker (price tags + 50 mm pressureclips + adapters)



Kit da 25 pz + 1 pennarello bianco (segnaprezzi+pinze da 50 mm)

Kit of 25 pcs + 1 white marker (price tags + 50 mm clips)



Kit da 25 pz + 1 pennarello bianco (segnaprezzi+pinze da 150 mm)

Kit of 25 pcs + 1 white marker (price tags + 150 mm clips)

SEGNAPREZZO CANCELLABILE FOREX EXTRA PER FRUTTA

Erasable extra forex price tag for fruits

COD: CPLAXF0105



D: 21 x 20 H cm

Segnaprezzo cancellabile serie lavagna in FOREX EXTRA per reparto frutta con tracciabilità prodotto. Materiale: FOREX espanso spessore 3 mm. Con foratura 4 mm.

Erasable product traceability extra forex blackboard for fruit price tag series. Made of: 3 mm thick expanded FOREX. With 4 mm holes.



GANCIO METALLICO PER SOSPENSIONE

Metal hook for suspension

D: 10 cm

D: 15 cm

▶ COD: CPAA010012

▶ COD: CPAA015012

D: 30 cm

D: 50 cm

▶ COD: CPAA030012

▶ COD: CPAA050012

D: 70 cm

D: 100 cm

▶ COD: CPAA070012

▶ COD: CPAA100012

COMBINAZIONI SEGNAPREZZO PER FRUTTA

Fruit price tag kits

COD: CPLAXF0605

COD: CPLAXF3005

COD: CPLAXF3105



Kit da 10 pz + 1 pennarello bianco (segnaprezzi+mollette da 50 mm+ adattatori)

Kit of 10 pcs + 1 white marker (price tags + 50 mm pressure clips + adapters)



Kit da 10 pz + 1 pennarello bianco (segnaprezzi+pinze da 50 mm)

Kit of 10 pcs + 1 white marker (price tags + 50 mm clips)



Kit da 10 pz + 1 pennarello bianco (segnaprezzi+pinze da 150 mm)

Kit of 10 pcs + 1 white marker (price tags + 150 mm clips)

SEGNAPREZZO CANCELLABILE FOREX EXTRA PER FRUTTA

Erasable extra forex price tag for fruits

COD : CPLAFF0105

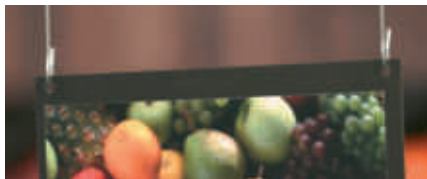

D: 29,7 x 31 H cm

Segnaprezzo cancellabile serie lavagna in FOREX EXTRA per reparto frutta con tracciabilità prodotto. Materiale: FOREX espanso spessore 3 mm. Con foratura 4 mm.

Product traceability extra forex erasable blackboard for fruit price tag series. Made of: 3 mm thick expanded FOREX. With 4mm holes.



GANCIO METALLICO PER SOSPENSIONE

Metal hook for suspension

D: 10 cm

D: 15 cm

▶ COD : CPAA010012

▶ COD : CPAA015012

D: 30 cm

D: 50 cm

▶ COD : CPAA030012

▶ COD : CPAA050012

D: 70 cm

D: 100 cm

▶ COD : CPAA070012

▶ COD : CPAA100012

COMBINAZIONI SEGNAPREZZO PER FRUTTA

Fruit price tag kits

COD. : CPLAFF3005

COD. : CPLAFF3105



Kit da 10 pz + 1 pennarello bianco (segnaprezzi+pinze da 50 mm)

Kit of 10 pcs + 1 white marker (price tags + 50 mm clips)



Kit da 10 pz + 1 pennarello bianco (segnaprezzi+pinze da 150 mm)

Kit of 10 pcs + 1 white marker (price tags + 150 mm clips)

SEGNAPREZZO CANCELLABILE FOREX EXTRA PER VERDURA

Erasable extra forex price tag for vegetables

COD: CPLAXV0105



D: 21 x 20 H cm

Segnaprezzo cancellabile in FOREX EXTRA per reparto verdura con tracciabilità prodotto. Materiale: FOREX espanso spessore 3 mm. Con foratura 4 mm.

Erasable product traceability extra forex price tag for vegetables. Material: 3 mm thick expanded FOREX. With 4mm holes.



GANCIO METALLICO PER SOSPENSIONE

Metal hook for suspension

D: 10 cm

D: 15 cm

COD: CPAA010012

COD: CPAA015012

D: 30 cm

D: 50 cm

COD: CPAA030012

COD: CPAA050012

D: 70 cm

D: 100 cm

COD: CPAA070012

COD: CPAA100012

COMBINAZIONI SEGNAPREZZO PER VERDURA

Price tag kits for vegetables

COD: CPLAXV0605

COD: CPLAXV3005

COD: CPLAXV3105



Kit da 10 pz + 1 pennarello bianco (segnaprezzi+mollette da 50 mm+ adattatori)

Kit of 10 pcs + 1 white marker (price tags + 50 mm clips + adapters)



Kit da 10 pz + 1 pennarello bianco (segnaprezzi+pinze da 50 mm)

Kit of 10 pcs + 1 white marker (price tags + 50 mm pliers)



Kit da 10 pz + 1 pennarello bianco (segnaprezzi+pinze da 150 mm)

Kit of 10 pcs + 1 white marker (price tags + 150 mm pliers)

SEGNAPREZZO CANCELLABILE FOREX EXTRA PER VERDURA

Erasable extra forex price tag for vegetables

COD: CPLAFV0105



D: 29,7 x 31 H cm



GANCIO METALLICO PER SOSPENSIONE

Metal hook for suspension

D: 10 cm

D: 15 cm

COD: CPAA010012

COD: CPAA015012

D: 30 cm

D: 50 cm

COD: CPAA030012

COD: CPAA050012

D: 70 cm

D: 100 cm

COD: CPAA070012

COD: CPAA100012

Segnaprezzo cancellabile in FOREX EXTRA per reparto verdura con tracciabilità prodotto. Materiale: FOREX espanso spessore 3 mm. Con foratura 4 mm.

Erasable product traceability extra forex price tag for vegetables. Made of : 3 mm thick expanded FOREX. With 4mm holes.

COMBINAZIONI SEGNAPREZZO PER VERDURA

Vegetable price tag kits

COD: CPLAFV3005

COD: CPLAFV3105



Kit da 10 pz + 1 pennarello bianco (segnaprezzi+pinze da 50 mm)

Kit of 10 pcs + 1 white marker (price tags + 50 mm pliers)



Kit da 10 pz + 1 pennarello bianco (segnaprezzi+pinze da 150 mm)

Kit of 10 pcs + 1 white marker (price tags + 150 mm pliers)

SEGNAPREZZO CANCELLABILE FOREX EXTRA PER OFFERTA ORTOFRUTTA

Erasable extra forex fruit and vegetable "Special Offer" price tag

COD : CPLAOF0105



D: 21 x 20 H cm



GANCIO METALLICO PER SOSPENSIONE

Metal hook for suspension

D: 10 cm

COD: CPAA010012

D: 15 cm

COD: CPAA015012

D: 30 cm

COD: CPAA030012

D: 50 cm

COD: CPAA050012

D: 70 cm

COD: CPAA070012

D: 100 cm

COD: CPAA100012

Segnaprezzo cancellabile in FOREX EXTRA ortofrutta con tracciabilità prodotto. Materiale: FOREX espanso spessore 3 mm. Con foratura 4 mm.
Erasable extra forex product traceability fruit and vegetable price tag. Made of 3 mm thick expanded FOREX. With 4mm holes.

COMBINAZIONI SEGNAPREZZO PER OFFERTA ORTOFRUTTA

Fruit and vegetable "Special Offer" combinations

COD: CPLAOF0605



Kit da 10 pz + 1 pennarello bianco
(segnaprezzi+mollette da 50 mm+ adattatori)
*Kit of 10 pcs + 1 white marker
(price tags + 50 mm pressure clips + adapters)*

COD: CPLAOF3005



Kit da 10 pz + 1 pennarello bianco
(segnaprezzi+pinze da 50 mm)
*Kit of 10 pcs + 1 white marker
(price tags + 50 mm clips)*

COD: CPLAOF3105



Kit da 10 pz + 1 pennarello bianco
(segnaprezzi+pinze da 150 mm)
*Kit of 10 pcs + 1 white marker
(price tags + 150 mm clips)*

SEGNAPREZZO CANCELLABILE FOREX EXTRA PER OFFERTA ORTOFRUTTA

Erasable extra forex fruit and vegetable "Special Offer" price tag

COD : CPLAOX0105



D: 29,7 x 31 H cm



GANCIO METALLICO PER SOSPENSIONE

Metal hook for suspension

D: 10 cm

COD: CPAA010012

D: 15 cm

COD: CPAA015012

D: 30 cm

COD: CPAA030012

D: 50 cm

COD: CPAA050012

D: 70 cm

COD: CPAA070012

D: 100 cm

COD: CPAA100012

Segnaprezzo cancellabile in FOREX EXTRA ortofrutta con tracciabilità prodotto. Materiale: FOREX espanso spessore 3 mm. Con foratura 4 mm.
Erasable extra forex product traceability fruit and vegetables price tag. Made of 3 mm thick expanded FOREX. With 4mm holes.

COMBINAZIONI SEGNAPREZZO PER ORTOFRUTTA

Fruit and vegetable "Special Offer" combinations

COD: CPLAOX3005



Kit da 10 pz + 1 pennarello bianco
(segnaprezzi+pinze da 50 mm)
*Kit of 10 pcs + 1 white marker
(price tags + 50 mm clips)*

COD: CPLAOX3105



Kit da 10 pz + 1 pennarello bianco
(segnaprezzi+pinze da 150 mm)
*Kit of 10 pcs + 1 white marker
(price tags + 150 mm clips)*

SEGNAPREZZO CANCELLABILE IN PLEXIGLASS

SEGNAPREZZO CANCELLABILE PER PESCHERIA TRACCIABILITÀ PRODOTTO

Erasable Perspex product traceability price tag for fishmonger's



COD: CPLALR0102



COD: CPLALR0308

COD: CPLALR0402



D: 13 x 20 H cm



Inserto protettivo in PVC rigido spessore 0,4 mm.
Protective insert hard PVC 0.4 mm thick.



D: 13 x 20 H cm

Segnaprezzo cancellabile con tracciabilità pescheria. Materiale: PMMA spessore 3 mm. Confezione da 10 pezzi. 1 Pennarello bianco.
Erasable product traceability price tag. Made of: 3mm thick PMMA. 10 piece package. 1 white marker.

COD: CPLALR0202



D: 13 x 24,6 H cm

Segnaprezzo cancellabile con tracciabilità e supplemento promozionale. Materiale: PMMA spes. 3 mm. Confezione 10 pezzi. 1 Pennarello bianco.
Erasable product traceability price tag with advertising accessory. Made of 3mm thick PMMA. Pack of 10 pcs. 1 white marker.

COD: CPLALR0505



D: 13 x 24,6 H cm

Stampato reverse
Reverse printed

Segnaprezzo cancellabile con tracciabilità prodotto. Materiale: PMMA spes. 3 mm. Confezione da 10 pezzi. 1 Pennarello bianco.
Erasable price tag with product traceability. Made of 3 mm thick PMMA. Pack of 10 pcs. 1 white marker.



COD: SEDVON5020



D: 50 x 20 cm

Divisorio pescheria in plexiglass sagomato onda. Materiale: PMMA spes. 3 mm.
Wave-shaped perspex divider for fishmonger's. Made of: 3 mm. thick PMMA

FRECCE PROMOZIONALI IN PLEXIGLASS.

Perspex promotional arrows

Frecce promozionali. Materiale: PMMA spessore 3 mm. Confezioni da 5 pezzi.
Promotional arrows. Made of 3 mm thick PMMA. Packs of 5 pcs.



COD: CGPSLRM06

COD: CGPSLRCV09



D: 44 x 14 H cm

D: 44 x 14 H cm

COD: CGPSLRFT02

COD: CGPSLRUM03



D: 44 x 14 H cm

D: 44 x 14 H cm

PENNARELLI PER SEGNAPREZZI

Price tag markers

PENNARELLO CON PUNTA A SEZIONE CIRCOLARE DA 5 MM
Felt-tip pen with circular section tip 5 mm

PENNARELLO GESSO LIQUIDO
Liquid chalk pen

05 01



Confezione 12 pz
Pack of 12 pcs

COD: CPIPFC01

Confezione 1 pz
Pack of 1 pc

COD: CPIPFC00



COD: CPIPFC02



LAVAGNE SAGOMATE CANCELLABILI

Eraseable shaped blackboard

Da oggi potrai creare e valorizzare il tuo spazio grazie alle nostre lavagne sagomate. Scopri la nostra linea di lavagne sagomate da tavolo, da parete, con sistema magnetico o base metallica e inizia a comunicare in modo semplice e originale.

Per i modelli da tavolo, la base (dove prevista) è compresa nel pezzo.

Con le nostre lavagne consigliamo l'uso di pennarelli a gesso liquido per una semplice pulizia.

Now you can create and enhance your space thanks to our shaped boards. Discover our line of table-shaped, wall-mounted, magnetic-based or metal-based blackboards and start communicating in a simple and original way.

For table top models, the base (where provided) is included in the piece.

With our boards we recommend the use of liquid chalk markers for easy cleaning.



Dimensioni basi lavagne da tavolo
Table board bases dimensions



D: 5 x 5 H cm



D: 10 x 10 H cm

LAVAGNE DA TAVOLO NEUTRE

Table boards

COD: CPLTNFX00005



D: 10 x 15 H cm

COD: CPLTNFX00105



D: 15 x 21 H cm

COD: CPLTNFX00205



D: 15 x 21 H cm

COD: CPLTNFX00305



D: 12 x 15 H cm

COD: CPLTNFX00405



D: 16 x 21 H cm

COD: CPLTNFX00505



D: 6 x 20 H cm

COD: CPLTNFX00605



D: 8 x 30 H cm

COD: CPLTNFX00705

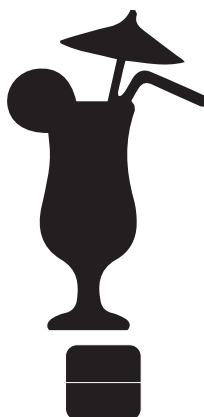

D: 25 x 40 H cm

COD: CPLTNFX00805



D: 24 x 25 H cm

COD: CPLTNFX00905

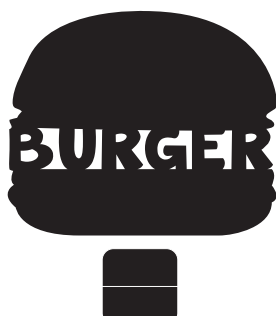

D: 30 x 35 H cm

COD: CPLTNFX01005



D: 35 x 23 H cm

COD: CPLTNFX01105



D: 21 x 33 H cm

COD: CPLTNFX01205



D: 15 x 21 H cm

COD: CPLTNFX01305



D: 20 x 30 H cm

COD: CPLTNFX01405

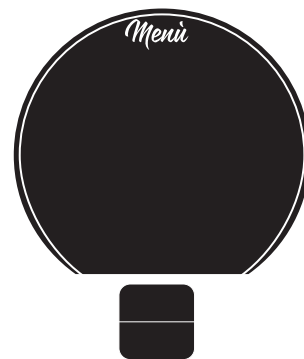

D: 40 x 36 H cm

COD: CPLTNFX01505



D: 30 x 15 H cm

COD: CPLTNFX01605



D: 23 x 30 H cm

COD: CPLTNFX01705



D: 30 x 50 H cm



LAVAGNE DA PARETE
Wallboards



COD: CPLPNFX00005

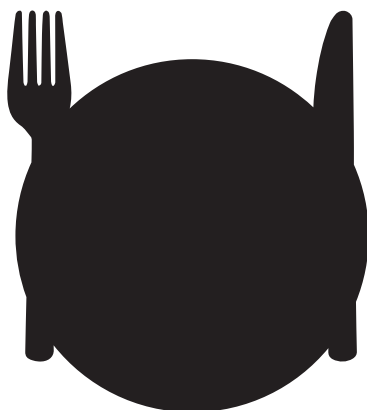

D: 45 x 50 H cm

COD: CPLPNFX00105



D: 50 x 70 H cm

COD: CPLPNFX00205



D: 30 x 70 H cm

COD: CPLPNFX00305

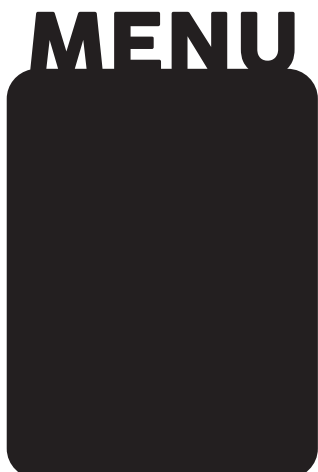

D: 30 x 45 H cm

COD: CPLPNFX00405

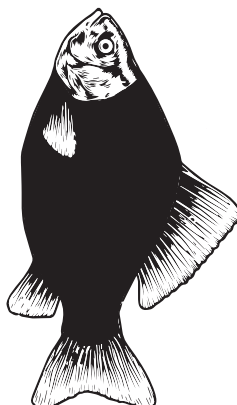

D: 60 x 35 H cm

COD: CPLPNFX00505



D: 100 x 80 H cm

LAVAGNE CON SISTEMA MAGNETICO

Blackboard with magnetic system



COD: CPLMNX00005

COD: CPLMNX00105

COD: CPLMNX00205



D: 73 x 140 H cm

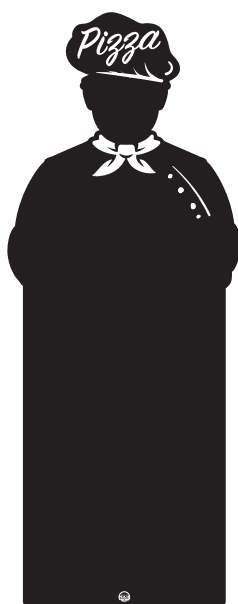

D: 55 x 140 H cm



D: 65 x 140 H cm

PIANTANA MAGNETICA

Magnetic Floor lamp



COD: CPPNMG33X130 D: 33 x 130 H cm

Piantana magnetica per lavagne magnetiche compresa di 4 piastre metalliche con biadesivo.

Magnetic floor lamp for magnetic boards including 4 metal plates with double-sided adhesive tape.

LAVAGNE CON BASE METALLICA

Blackboard with metallic base

COD: CPLBFX73X140



D: 73 x 140 H cm

PENNARELLI

Markers.....

PENNARELLI CHALK MARKER

Chalk markers



COD: CIPCF0201



Non tossici
No toxic



Lavabili con acqua
Washable with water



Made in Italy
Made in Italy



ATTACCHI E ACCESSORI

Supports and accessories

Gli attacchi e accessori per i segnaprezzi è di nostra produzione, con l'introduzione di alcune novità rispetto ai cataloghi precedenti che invitiamo a valutare con attenzione.

Supports and accessories for price tags are our own production. We lately introduced some new items and choices you should carefully compare to our previous catalogues



ATTACCHI PER SEGNAPREZZI : AGHI

Price tag holders: needles



COD: CPAAAG04

COLORI:
COLOURS:

01 05



Ago inox. Materiale: POM e acciaio AISI304. Confezione da 25 pezzi
Stainless steel needle. Made of POM and steel. AISI304. 25 pcs package

COD: CPAAAG05

COLORI:
COLOURS:

01 05



Ago doppia punta. Materiale: POM. Confezione da 25 pezzi.
Double pointed needle. Made of POM. 25 pcs package.

COD: CPAAAG01

COLORI:
COLOURS:

01 05



Ago doppia punta standard. Materiale: POM. Confezione da 25 pezzi.
Standard double pointed needle. Made of POM. 25 pcs package.

COD: CPAAAIAP

COLORI:
COLOURS:

01 05



Ago inox con adattatore piano. Materiale: POM e acciaio AISI304.
Confezione da 25 pezzi.
Inox needle with flat adapter AISI304. Made of POM and steel.
25 pcs package.

COD: CPAAAIKL

COLORI:
COLOURS:

01 05



Ago inox con clip a pressione. Materiale: POM e acciaio AISI304.
Confezione da 25 pezzi.
Inox needle with pressure clip AISI304. Made of POM and steel.
25 pcs package.

COD: CPAAAIIV

COLORI:
COLOURS:

01 05



Ago inox con adattatore verticale. Materiale: POM e acciaio AISI304
Confezione da 25 pezzi.
Stainless steel needle with vertical adapter AISI304. Made of POM and
steel. 25 pcs package.

COD: CPAAIC7

COLORI:
COLOURS:

01 05



Ago inox con inserto a "C" A7. Materiale: POM e acciaio AISI304
Confezione da 25 pezzi.
Inox needle with a "C"-shaped A7 accessory AISI304. Made of POM and steel. 25 pcs package.

COD: CPAAIC6

COLORI:
COLOURS:

01 05



Ago inox con inserto a "C" A6. Materiale: POM e acciaio AISI304. Confezione da 25 pezzi.
Inox needle with a "C"-shaped A6 accessory AISI304. Made of POM and steel. 25 pcs package.

COD: CPAAAPAP

COLORI:
COLOURS:

01 05



Ago doppia punta con adattatore piano. Materiale: POM.
Confezione da 25 pezzi.
Double pointed needle with flat adapter. Made of: POM. 25 pcs package.

COD: CPAAAPCL

COLORI:
COLOURS:

01 05



Ago doppia punta con clip a pressione Materiale: POM.
Confezione da 25 pezzi.
Double pointed needle with pressure clips Made of: POM. 25 pcs package.

COD: CPAAAPAV

COLORI:
COLOURS:

01 05



Ago doppia punta con adattatore verticale. Materiale: POM
Confezione da 25 pezzi.
Double pointed needle with vertical adapter Made of: POM 25 pcs package

COD: CPAAAPC7

COLORI:
COLOURS:

01 05



Ago doppia punta con inserto a "C" A7. Materiale: POM
Confezione da 25 pezzi.
Double pointed needle with a "C"-shaped A7 accessory Made of: POM 25 pcs package

COD: CPAAAPC6

COLORI:
COLOURS:

01 05



Ago doppia punta con inserto a "C" A6. Materiale: POM
Confezione da 25 pezzi.
Double pointed needle with a "C"-shaped A6 accessory Made of: POM 25 pcs package

ATTACCHI PER SEGNAPREZZI : ASTE E INSERTI

Price tag holders: rods and inserts



COD: CPAAAT01

COLORI:
COLOURS:

01 05



Asta triangolare. Materiale: POM. Confezione da 25 pezzi.
Triangular rod. Made of POM. 25 pcs package.

COD: CPAAAT0208



Asta per il ghiaccio trasparente. Altezza: 15 cm Materiale: POM.
Confezione da 25 pezzi.
Transparent ice rod. Height: 15 cm Made of POM. 25 pcs package.

COD: CPAAAGC7

COLORI:
COLOURS:

01 05



Asta per il ghiaccio trasparente con inserto a "C" A7. Materiale: POM.
Confezione da 25 pezzi.
Transparent ice rod with an A7 "C"-shaped accessory. Made of POM.
25 pcs package

COD: CPAAAGC6

COLORI:
COLOURS:

01 05



Asta per il ghiaccio trasparente con inserto a "C" A6. Materiale:
POM. Confezione da 25 pezzi.
Transparent ice stick with an A6 "C"-shaped accessory. Made of POM.
25 pcs package.

ATTACCHI PER SEGNAPREZZI : MOLLETTE E PINZE

Price tag holders: clips and tongs



MOLLETTONE PER CASSETTE CON ASTA

COLORI/ COLOURS:

01 05



- ▶ COD: CPAAM00505 L: 5 cm
- ▶ COD: CPAAM01005 L: 10 cm
- ▶ COD: CPAAM01505 L: 15 cm

Materiale: POM. Confezione da 25 pezzi
Large clip for boxes with stick Made of : POM. 25 pcs package.

COD: CPAATN01

COLORI/ COLOURS:

01 05



Molletta.Materiale: POM. Confezione 25 pezzi
Clip. Made of : POM. 25 pcs package.

COD: CPAATJ08

COLORI/ COLOURS:

01 05



Molletta per snodi. Materiale: POM. Confezione da 25 pezzi
Clip for joints. Made of POM. 25 pcs package.

COD: CPAATNCL

COLORI/ COLOURS:

01 05



Molletta con clip. Materiale: POM. Confezione da 25 pezzi
Clip.Made of: POM. 25 pcs package.

ASTA PER SNODI

COLORI/ COLOURS:

01 05



- ▶ COD: CPAAAT05 L: 5 cm
- ▶ COD: CPAAAT10 L: 10 cm
- ▶ COD: CPAAAT15 L: 15 cm

Materiale: POM Confezione da 25 pezzi.
Junction stick. Made of : POM. 25 pcs package.

COD: CPAACLC101

COLORI/ COLOURS:

01 05



Clip a chiocciola per ripiani con adattatore verticale Materiale: PC + POM. Confezione da 25 pezzi
Spiral clip for shelves with vertical adapter Made of : PC + POM. 25 pcs package

MOLLETTA CON ASTA

COLORI/ COLOURS: 01 05



- ▶ COD: CPAASA05 L: 5 cm
- ▶ COD: CPAASA10 L: 10 cm
- ▶ COD: CPAASA15 L: 15 cm

Materiale: POM. Confezione da 25 pezzi
 Large clip for boxes with stick Made of: POM. 25 pcs package

MOLLETTA CON SNODO ASTA CON ADATTATORE PIANO

COLORI/ COLOURS: 01 05



- ▶ COD: CPAASE05 L: 5 cm
- ▶ COD: CPAASE10 L: 10 cm
- ▶ COD: CPAASE15 L: 15 cm

Materiale: POM Confezione da 25 pezzi
 Clip. Made of: POM. 25 pcs package

MOLLETTA CON ASTA CON ADATTATORE VERTICALE

COLORI/ COLOURS: 01 05



- ▶ COD: CPAAST05 L: 5 cm
- ▶ COD: CPAAST10 L: 10 cm
- ▶ COD: CPAAST15 L: 15 cm

Materiale: POM Confezione da 25 pezzi
 Clip with vertical adapter. Made of: POM 25 pcs package

MOLLETTA CON SNODO ASTA CON CLIP A PRESSIONE

COLORI/ COLOURS: 01 05



- ▶ COD: CPAASC05 L: 5 cm
- ▶ COD: CPAASC10 L: 10 cm
- ▶ COD: CPAASC15 L: 15 cm

Materiale: POM. Confezione da 25 pezzi
 Junction pressure clip with stick. Made of: POM. 25 pcs package

MOLLETTA CON ASTA E INSERTO A "C" A7

COLORI/ COLOURS: 01 05



- ▶ COD: CPAAS705 L: 5 cm
- ▶ COD: CPAAS710 L: 10 cm
- ▶ COD: CPAAS715 L: 15 cm

Materiale: POM. Confezione da 25 pezzi
 Twisting clip for rear stand with vertical adapter. Made of: PC + POM. 25 pcs package

MOLLETTA CON ASTA E INSERTO A "C" A6

COLORI/ COLOURS: 01 05



- ▶ COD: CPAAS605 L: 5 cm
- ▶ COD: CPAAS610 L: 10 cm
- ▶ COD: CPAAS615 L: 15 cm

Materiale: POM. Confezione da 25 pezzi
 Twisting clip with a stick and a "C" A6 insert Made of: PC + POM. 25 pcs package

PINZA SNODABILE CON ADATTATORE VERTICALE

COLORI/ COLOURS: 05 08



- ▶ COD: CPAAPSAV

Materiale: PC. Confezione da 25 pezzi
 Swivel tong with vertical adapter. Made of: PC+POM. 25 pcs package

COD: CPAAPZ0105



Pinza con asta. Apertura max. di 35mm. Lunghezza asta: 50 mm.
 Materiale: ABS. Confezione da 25 pezzi
 Clip with stick, 35mm. max. opening Stick length: 50 mm. Made of: ABS. 25 pcs package

COD: CPAAPZ0205



Pinza con asta. Apertura max. di 35mm. Lunghezza asta: 150 mm.
 Materiale: ABS. Confezione da 25 pezzi
*Clip with stick, 35mm.max. opening. Stick length: 150 mm.
 Made of : ABS. 25 pcs package*

COD: CPAAPZM105



Pinza con asta e attacco a molla. Apertura max. di 35mm.
 Lunghezza asta: 50 mm. Materiale: ABS. Confezione da 25 pezzi
*Clip with stick and spring 35mm.max. opening Stick length: 50 mm.
 Made of: ABS. 25 pcs package*

COD: CPAAPZM205



Pinza con asta e attacco a molla. Apertura max. di 35mm.
 Lunghezza asta: 150 mm. Materiale: ABS. Confezione da 25 pezzi
*Clip with stick and spring 35mm.max opening Stick length: 150 mm.
 Made of : ABS. 25 pcs package*

COD: CPAAPZF105



Pinza con asta per lavagne forex da 3mm. Apertura max. di 35mm.
 Lunghezza asta: 50 mm. Materiale: ABS. Confezione da 25 pezzi
*Forex blackboard clip with stick (max 3mm). 35mm max. opening.
 Stick length: 50 mm. Made of : ABS. 25 pcs package*

COD: CPAAPZF205



Pinza con asta per lavagne forex da 3mm. Apertura max. di 35mm.
 Lunghezza asta: 150 mm. Materiale: ABS. Confezione da 25 pezzi
*Forex blackboard clip with stick (max 3mm). 35mm max. opening.
 Stick length: 150 mm. Made of : ABS. 25 pcs package*

COD: CPAAPZP105



Pinza con adattatore piano. Apertura max. di 35mm.
 Lunghezza asta: 50 mm. Materiale: ABS. Confezione da 25 pezzi
*Clip with flat adapter. 35mm max- opening. Stick length: 50 mm.
 Made of : ABS. 25 pcs package*

COD: CPAAPZP205



Pinza con adattatore piano. Apertura max. di 35mm.
 Lunghezza asta: 150 mm. Materiale: ABS. Confezione da 25 pezzi
*Clip with flat adapter. 35mm max. opening. Stick length: 150 mm.
 Made of : ABS. 25 pcs package*

COD: CPAAPZV105



Pinza con asta e adattatore verticale. Apertura max. di 35mm.
 Lunghezza asta: 50 mm. Materiale: ABS. Confezione da 25 pezzi
*Clip with stick and vertical adapter. 35mm max. opening.
 Stick length: 50 mm. Made of : ABS. 25 pcs package*

COD: CPAAPZV205



Pinza con asta e adattatore verticale. Apertura max. di 35mm.
 Lunghezza asta: 150mm. Materiale: ABS. Confezione da 25 pezzi
*Clip with stick and vertical adapter. 35mm. max opening
 Stick length: 150 mm. Made of : ABS. 25 pcs package*

COD: CPAAPZC1



Pinza con asta e clip a pressione. Apertura max. di 35mm. Lunghezza
 asta: 50 mm. Materiale: ABS. Confezione da 25 pezzi
*Clip with stick and pressure clip. 35mm max. opening. Stick length: 50
 mm. Made of : ABS. 25 pcs package*

COD: CPAAPZC2



Pinza con asta e clip a pressione. Apertura max. di 35mm. Lunghezza asta: 150 mm. Materiale: ABS. Confezione da 25 pezzi
 Clip with stick and pressure clip. 35mm max. opening. Stick length: 150 mm. Made of: ABS. 25 pcs package

COD: CPAASN01



Snodo con porta messaggi e pinza a molla. Senza asta.
 Materiale: PC + FE. Confezioni da 25 pezzi
 Junction with label holder and spring clip. Without arm. Made of: PC + FE 25 pcs package

COD: CPAASN0508



Snodo con porta messaggi e pinza a molla. Lunghezza asta: 50 mm.
 Materiale: PC + FE. Confezioni da 25 pezzi
 Junction with label holder and spring clip. Stick length: 50 mm. Made of: PC + FE. 25 pcs package

COD: CPAASN10



Snodo con porta messaggi e pinza a molla. Lunghezza asta: 100 mm.
 Materiale: PC + FE. Confezioni da 25 pezzi
 Junction with label holder and spring clip. Stick length: 100 mm. Made of: PC + FE. 25 pcs package

ATTACCHI PER SEGNAPREZZI : MINI PIANTANE

Price tag holders: extra small display stands



COD: CPAAQT01

COLORI/ COLOURS: 01 05 08

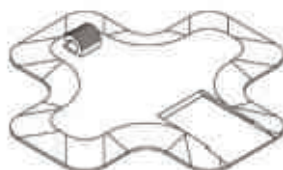
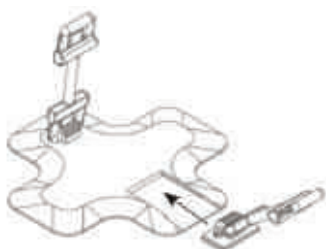

Basi a quadrifoglio Dimensione: 11 x 10 cm Confezione da 25 pezzi. Materiale: POM
Cloverleaf base support Size: 11 x 10 cm. 25 pcs package. Made of: POM

PIANTANA CON ASTA

COLORI/ COLOURS: 01 05 08



- COD: CPAAQW05 L: 5 cm
- COD: CPAAQW10 L: 10 cm
- COD: CPAAQW15 L: 15 cm

Confezioni da 25 pezzi. Materiale: POM
Cloverleaf base support without adapter. 25 pcs package.
Made of: POM

PIANTANA CON ASTA E ADATTATORE PIANO

COLORI/ COLOURS: 01 05 08



- COD: CPAAQE05 L: 5 cm
- COD: CPAAQE10 L: 10 cm
- COD: CPAAQE15 L: 15 cm

Confezioni da 25 pezzi. Materiale: POM
Cloverleaf base support with flat adapter. 25 pcs package
Made of: POM

PIANTANA CON ASTA E ADATTATORE VERTICALE 01 05 08



- COD: CPAAQT05 L: 5 cm
- COD: CPAAQT10 L: 10 cm
- COD: CPAAQT15 L: 15 cm

Confezioni da 25 pezzi. Materiale: POM
Cloverleaf base support with vertical adapter. 25 pcs package.
Made of: POM

PIANTANA CON ASTA E CLIP 01 05 08



- COD: CPAAQC05 L: 5 cm
- COD: CPAAQC10 L: 10 cm
- COD: CPAAQC15 L: 15 cm

Confezioni da 25 pezzi. Materiale: POM
Cloverleaf base support with pressure clips. Made of: POM
25 pcs package

PIANTANA CON ASTA E ADATTATORE A "C" A7
 COLORI/ COLOURS:



- COD: CPAAQ705 L: 5 cm
- COD: CPAAQ710 L: 10 cm
- COD: CPAAQ715 L: 15 cm

Confezioni da 25 pezzi. Materiale: POM
 Cloverleaf base support with an A7 "C"-shaped accessory. 25 pcs package. Made of POM

PIANTANA CON ASTA E ADATTATORE A "C" A6
 COLORI/ COLOURS:



- COD: CPAAQ605 L: 5 cm
- COD: CPAAQ610 L: 10 cm
- COD: CPAAQ615 L: 15 cm

Confezioni da 25 pezzi. Materiale: POM
 Cloverleaf base support with an A6 "C"-shaped accessory. 25 pcs package. Made of POM

PIANTANA CON ASTA SNODABILE E PINZA
 COLORI/ COLOURS:



- COD: CPAAQP05 L: 5 cm
- COD: CPAAQP10 L: 10 cm
- COD: CPAAQP15 L: 15 cm

Confezioni da 25 pezzi. Materiale: POM
 Cloverleaf base support with a jointed stick and a spring clip. 25 pcs package. Made of: POM

PIANTANA CON CLIP PORTA MESSAGGI OVALE
 COLORI/ COLOURS:



- COD: CPAAQM05 L: 5 cm
- COD: CPAAQM10 L: 10 cm
- COD: CPAAQM15 L: 15 cm

Confezioni da 25 pezzi. Materiale: POM
 Cloverleaf base support with oval tag holder. 25 pcs package. Made of: POM

PIANTANA CON ASTA SNODABILE E CLIP
 COLORI/ COLOURS:

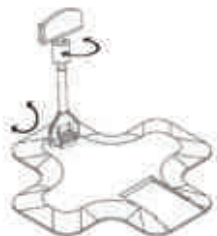

- COD : CPAAQS05 L: 5 cm
- COD : CPAAQS10 L: 10 cm
- COD : CPAAQS15 L: 15 cm

Confezioni da 25 pezzi. Materiale: POM
 Cloverleaf base support with a jointed stick and tag holder. 25 pcs package Made of: POM

COD: CPAAIG01
 COLORI/ COLOURS:

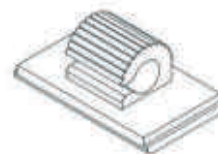

Adattatore piano. Materiale: POM. Confezione da 25 pezzi.
 Flat adapter. Made of: POM. 25 pcs package

PIANTANA CON BASE E ASTA INOX PIÙ ADATTATORE



- COD : CP27-PIA12 L: 10 cm
- COD : CP28-PIA12 L: 15 cm

Materiale: STS
 Display stand with base and stainless steel rod plus adapter.
 Made of: STS

ADATTATORE PER PIANTANA INOX
 COLORI/ COLOURS:



COD : CP29-ATT

Materiale: POM. Confezione da 25 pezzi.
 Adapter for stainless steel display stand. Made of: POM. 25 pcs package

MASSIMA RESISTENZA ALLE ALTE TEMPERATURE.
MAXIMUM RESISTANCE TO HIGH TEMPERATURES.



ATTACCHI PER SEGNAPREZZI

Price tag holders

COD: CPAAMU64

COLORI/ COLOURS:

01 05



Adattatore verticale. Materiale: POM. Confezione da 25 pezzi.
Vertical adapter. Made of: POM. 25 pcs package.

COD: CPAASL6401



Slitta per adattatore verticale. Materiale: POM. Confezione da 25 pezzi.
Vertical adapter slide. Made of POM. 25 pcs package

COD: CPAABS0101



Adattatore basculante. Materiale: POM. Confezione da 25 pezzi.
Tilting adapter. Made of: POM. 25 pcs package.

COD: CPAADHOT08



Coppia di ganci per diametro max. 20mm. Dimensioni: 26 x 64 mm
Materiale: PC. Confezione da 20 pezzi.
20mm max diametre pair of hook. Size:26X64mm. Made of: PC
20 pcs package

COD: CPAAIG01

COLORI/ COLOURS:

01 05



Adattatore piano. Materiale: POM. Confezione da 25 pezzi.
Flat adapter. Made of: POM. 25 pcs package.

COD: CPAACL02

COLORI/ COLOURS:

01 05



Clip con porta messaggi ovale per spessore max 0,6 mm. Materiale: PC
0,6 mm max thickness oval label holder clip. Made of: PC

COD: CPAAIN07

COLORI/ COLOURS:

01 05



Adattatore a "C" per lavagne formato A7. Materiale: POM.
Confezione da 25 pezzi.
A7 "C-shaped" blackboard adapter. Made of: POM. 25 pcs package

COD: CPAAIN06

COLORI/ COLOURS:

01 05



Adattatore a "C" per lavagne formato A6. Materiale: POM.
Confezione da 25 pezzi.
A6 "C"-shaped blackboard adapter. Made of: POM. 25 pcs package.

COD: CPAACL01

COLORI/ COLOURS:

01 05



Clip a pressione. Materiale: POM.
Confezione da 25 pezzi.
Pressure clip. Made of: POM.
25 piece package.

COD: CPAASV01

COLORI/ COLOURS:

01 05



Supporto per supplementi visivi
Materiale: POM. Confezione da 25 pezzi
Dispaly accessories support. Made of:
POM. 25 pcs package.

COD: CPAASVCL

COLORI/ COLOURS:

01 05



Cursore con supporto supplemento visivo
con clip a pressione. Materiale: POM.
Confezione da 25 pezzi.
Cursor with display accessory support and
pressure clip. Made of POM: 25 pcs package

PROFILI PORTAPREZZO

Price holders profiles



PROFILO PORTA PREZZO PIATTO ADESIVO

Flat adhesive profile price holder

COLORI/ COLOURS:

01 08



Altezza 3 cm
Height 3 cm

▶ COD: CPPRADH310 L: 98,8 cm

▶ COD: CPPRADH313 L: 131,8 cm



Altezza 4 cm
Height 4 cm

▶ COD: CPPRADH410 L: 98,8 cm

▶ COD: CPPRADH413 L: 131,8 cm

PROFILO PORTA PREZZO ADESIVO INCLINATO 105°

105°inclined adhesive profile price holder

COLORI/ COLOURS:

01 08



Altezza 4 cm
Height 4 cm

▶ COD: CPPR102S10 L: 98,8 cm

▶ COD: CPPR102S13 L: 131,8 cm



PROFILO PORTA PREZZO TEGOMETALL 50

P50 Tegometall profile price holder

COLORI/ COLOURS:

01 08



Altezza 4 cm
Height 4 cm

▶ COD: CPPRTGM410 L: 98,8 cm

▶ COD: CPPRTGM413 L: 131,8 cm



PROFILO PORTA PREZZO P25 CEFLA BASCULANTE

Cefla P25 tilting profile price holder.

COLORI/ COLOURS:

01 08



Altezza 4 cm
Height 4 cm

▶ COD: CPPRCEB410 L: 98,8 cm

▶ COD: CPPRCEB413 L: 131,8 cm



PROFILO PORTA PREZZO P25 LA FORTEZZA

La Fortezza P25 tilting profile price holder COLORI/ COLOURS:

01 08



Altezza 4 cm
Height 4 cm

▶ COD: CPPRPET410 L: 98,8 cm

▶ COD: CPPRPET413 L: 131,8 cm



PROFILO PORTA PREZZO PER CESTI

Basket profile price holder

COLORI/ COLOURS:

01 08



Altezza 4 cm
Height 4 cm

▶ COD: CPPR032101 L: 98,8 cm



PROFILO PER RIPIANI IN VETRO SPESSORE 6-10 MM

6-10mm thick glass shelf profile price holder

COLORI/ COLOURS:

01 08



Non basculante Altezza 3 cm
Not tilting Height 3 cm

▶ COD: CPPRTA2605 L: 98,8 cm

▶ COD: CPPRTA2608 L: 131,8 cm



PROFILO PER RIPIANI IN VETRO SPESSORE 8-12 MM

8-12mm thick glass shelf profile price holder

COLORI/ COLOURS:

01 08



Basculante Altezza 4 cm
Tilting Height 4 cm

▶ COD: CPPRTVB410 L: 98,8 cm

▶ COD: CPPRTVB413 L: 131,8 cm



Non basculante Altezza 4 cm
Not tilting Height 4 cm

▶ COD: CPPR046010 L: 98,8 cm

▶ COD: CPPR046013 L: 131,8 cm

PROFILO ALSER CON RETRO ALETTA

Alser profile price holder with rear wing

COLORI/ COLOURS:

01 08



Altezza 4 cm
Height 4 cm

▶ COD: CPPRALG310 L: 98,8 cm

▶ COD: CPPRALG313 L: 131,8 cm



PROFILO P50 CON RETROALETTA 30,5 MM

P50 profile price holder with rear wing

COLORI/ COLOURS:

01 08



Altezza 3 cm
Height 3 cm

▶ COD: CPPRCEG310 L: 98,8 cm

▶ COD: CPPRCEG313 L: 131,8 cm



Altezza 4 cm
Height 4 cm

▶ COD: CPPRCEG410 L: 98,8 cm

▶ COD: CPPRCEG413 L: 131,8 cm

PROFILO PORTA PREZZO CEFLA SYSTEM 10

Cefla System 10 profile price holder

COLORI/ COLOURS:

01 08



Altezza 3 cm
Height 3 cm

▶ COD: CPPRSY1020 L: 98,8 cm

▶ COD: CPPRSY1023 L: 131,8 cm



Altezza 4 cm
Height 4 cm

▶ COD: CPPRSY1010 L: 98,8 cm

▶ COD: CPPRSY1013 L: 131,8 cm

PROFILO PORTA PREZZO 90°

90 degrees price holder

COLORI/ COLOURS:

01 08



Altezza 4 cm
Height 4 cm

▶ COD: CPPR111510 L: 98,8 cm

▶ COD: CPPR111513 L: 131,8 cm



PORTA BROCHE CON CAVA UNIVERSALE

Brooch holder with universal track

COLORI/ COLOURS:



Altezza 4 cm
Height 4 cm

- ▶ COD : CPPR041260 L: 6 cm
- ▶ COD : CPPR041265 L: 6,5 cm
- ▶ COD : CPPR041275 L: 7,5 cm

PROFILO PORTA PREZZO BASCULANTE INTRAC

Intrac tilting profile price holder h40

COLORI/ COLOURS:



Altezza 4 cm
Height 4 cm

- ▶ COD: CPPRTRC110 L: 98,8 cm
- ▶ COD: CPPRTRC113 L: 131,8 cm

NEW PRODUCTS

PROFILO PORTA PREZZO NUOVO INTRAC

Intrac tilting profile price holder h30

COLORI/ COLOURS:



Basculante Altezza 3 cm
Tilting Height 3 cm

- ▶ COD: CPPRTR3100 L: 98,8 cm
- ▶ COD: CPPRTR3113 L: 131,8 cm

Per nuovi ripiani INTRAC
For new INTRAC shelves

PROFILO PORTA PREZZO ARNEG

Arneg price holder profile

COLORI/ COLOURS:

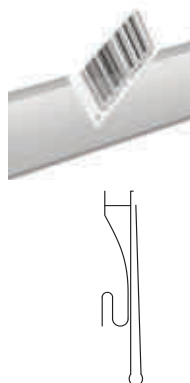

Altezza 4 cm
Height 4 cm

- ▶ COD: CPPRANG074 L: 74 cm
- ▶ COD: CPPRANG124 L: 124,5 cm



PROFILO PORTA PREZZO HERMÉS METAL

Hermés metal price holder profile

COLORI/ COLOURS:



Altezza 4 cm
Height 4 cm

- ▶ COD: CPPRHEM100 L: 98,8 cm
- ▶ COD: CPPRHEM113 L: 131,8 cm

BANDE PER PROFILI PORTA PREZZO

Bands for price profiles

BANDA COLORATA PER PROFILI PORTA PREZZO

COLORI/ COLOURS:



- ▶ COD: CPPRBC0P26
D: 2,6 x 10 cm
- ▶ COD: CPPRBC0P39
D: 3,9 x 10 cm

BANDA COLORATA PER PROFILI PORTA PREZZO

Coloured ribbon for price holder profiles



- ▶ COD: CPPRBC0C38
D: 3,8 x 10 cm

Materiale: PVC spessore 0.2mm
Coloured ribbon for profile price holder profiles Made of 0.2mm thick PVC

Materiale: Cartoncino 200gr
Made of : 200gr cardboard



GLOBAL
Communication



Comunicazione
GLOBALE

CONVENIENTE
SEMPRE

CONVENIENTE
SEMPRE

CONVENIENTE
SEMPRE

Dixan
CLASSICO



SUPPORTI PROMOZIONALI *Promotional holders*

I supporti promozionali che troverete sfogliando le prossime pagine sono di nostra produzione al 100% e i nostri reparti tecnici e grafici sono in grado di studiare e proporre soluzioni che possano venire incontro a qualsiasi esigenza. Avendo il completo controllo di tutte le fasi produttive siamo in grado di gestire sia ordini importanti per quantità sia lotti molto ridotti. Non esitate, quindi, a renderci note le vostre esigenze

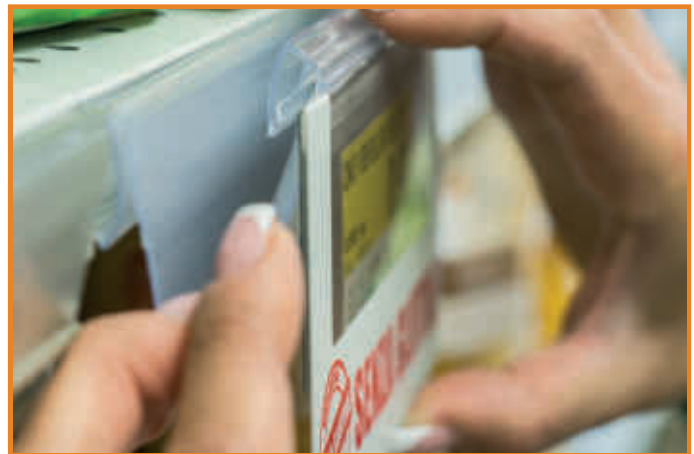

The promotional supports that you will see reading the following pages are 100% our production. Our technical and graphic departments can easily study and propose solutions which can meet all your needs. Having the complete control of all the production phases, we can manage to handle both large and small orders. So don't hesitate to let us know what you need.



MAGIC FRAME VERTICALE
Vertical magic frame



- ▶ COD: CGPSMFA408 D: 21 X 29,7 cm
- ▶ COD: CGPSMFA308 D: 29,7 X 42 cm

Supporto universale riutilizzabile per qualsiasi tipo di comunicazione.
Materiale: PVC + banda siliconica
Vertical Magic Frame. Re-usable and universal; fit for any kind of communication. Made of: PVC + silicone band

MAGIC FRAME ORIZZONTALE
Horizontal magic frame



- ▶ COD: CGPSMHA408 D: 29,7 X 21 cm
- ▶ COD: CGPSMHA308 D: 42 X 29,7 cm

Supporto universale riutilizzabile per qualsiasi tipo di comunicazione.
Materiale: PVC + banda siliconica
Horizontal Magic Frame. Re-usable and universal fit for any kind of communication. Made of: PVC + silicone band

TASCA ORIZZONTALE PER PROFILI SCANNER
Horizontal pocket holder for scanner profiles

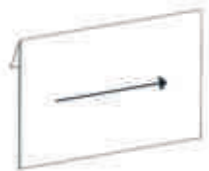

- ▶ COD: CGPSAH0608 D: 14,8 X 10,5 cm
- ▶ COD: CGPSAH0508 D: 21 X 14,8 cm
- ▶ COD: CGPSAH0408 D: 29,7 X 21 cm

Materiale: PVC antiriflesso, spessore 0,3mm
Made of: 0.3 mm anti glare PVC

TASCA VERTICALE PER PROFILI SCANNER
Vertical pocket holder for scanner profiles



- ▶ COD: CGPSAV0608 D: 10,5 X 14,8 cm
- ▶ COD: CGPSAV0508 D: 14,8 X 21 cm
- ▶ COD: CGPSAV0408 D: 21 X 29,7 cm

Materiale: PVC antiriflesso, spessore 0,3 mm
Made of: 0.3 mm anti glare PVC

TASCA ORIZZONTALE PER PROMO STOP BASCULANTE
Horizontal pocket holder for ads with tilting stop



- ▶ COD: CGPSABH608 D: 14,8 X 10,5 cm
- ▶ COD: CGPSABH508 D: 21 X 14,8 cm

Materiale: PVC antiriflesso, spessore 0,3 mm
Made of: 0.3 mm anti glare PVC

TASCA VERTICALE PER PROMO STOP BASCULANTE
Vertical pocket holder for ads with tilting stop.



- ▶ COD: CGPSABV508 D: 10,5 X 14,8 cm
- ▶ COD: CGPSABV508 D: 14,8 X 21 cm

Materiale: PVC antiriflesso, spessore 0,3 mm
Made of: 0.3 mm anti glare PVC

ESPOSITORE PORTA MESSAGGI REVERSIBILE
Reversible tag holder display

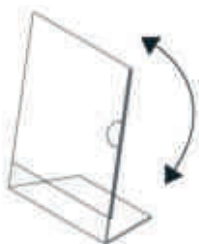

- ▶ COD: CGEBA3VR08 D: 29,7 X 42 cm
- ▶ COD: CGEBA4VR08 D: 21 X 29,7 cm
- ▶ COD: CGEBA5VR08 D: 14,8 X 21 cm
- ▶ COD: CGEBA6VR08 D: 10,5 X 14,8 cm

Materiale: ACR spessore 2 mm
Made of: 2 mm thick ACR

ESPOSITORE PORTA MESSAGGI REVERSIBILE
Reversible tag holder display



- ▶ COD: CGEBA4VH08 D: 21 X 29,7 cm
- ▶ COD: CGEBA5VH08 D: 14,8 X 21 cm

Materiale: ACR spessore 1 mm
Made of: 1 mm thick ACR



PROMOSTOP

Evidenziare le promozioni sullo scaffale con stopper o bandierine in grado di comunicare con impatto è essenziale per i punti vendita.

Per questo mettiamo a Vostra disposizione una vasta gamma di soluzioni: promostop a bandiera o lineari, basculanti e non, termosaldati, sagomati.

Tutte le tipologie sono interamente personalizzabili nella grafica e nelle dimensioni.

Molti dei codici di questa sezione si riferiscono a prodotti che vanno poi dettagliati in base alle Vostre richieste. Il loro inserimento nel catalogo è finalizzato solo all'identificazione del tipo di prodotto cercato.



PRODOTTI PERSONALIZZABILI
DIMENSIONI, COLORI, MATERIALI SU MISURA



PROMO TALKERS

It is vital to retail businesses to communicate in a fast and clear way highlighting offers by promo talkers. That's why here we introduce you to a wide range of articles: flag-shaped or linear, tilting and not, heat-sealed, shaped.

All items can be customized both in graphics and sizes.

In this section you will find a lot of products that can be detailed according to your request using our codes. Their inclusion in the catalogue aims only at identifying the kind of product sought



PROMOSTOP

PROMOSTOP NON TERMOSALDATO FISSO PER RIPIANI
Fixed not-heat sealed promo talker for shelves



- ▶ COD: CGPSTF0108 D: 15 X 8 cm
- ▶ COD: CGPSTF0208 D: 18 X 8 cm

Materiale: PVC
Made of: PVC

PROMOSTOP NON TERMOSALDATO BASCULANTE PER RIPIANI
Tilting promo talker not heat-sealed for shelves



- ▶ COD: CGPSTB0108 D: 15 X 8 cm
- ▶ COD: CGPSTB0208 D: 18 X 8 cm

Materiale: PVC
Made of: PVC

PROMOSTOP FISSO TERMOSALDATO
Fixed heat-sealed promo talker

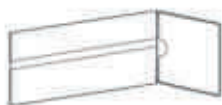

- ▶ COD: CGPSTF0308 D: 8 X 8 cm
- ▶ COD: CGPSTF0408 D: 11 X 8 cm
- ▶ COD: CGPSTF0508 D: 15 X 8 cm
- ▶ COD: CGPSTF0608 D: 18 X 8 cm

Con busta 8 x 8 a bandiera. Materiale: PVC
With 8 x 8 flag envelope. Made of: PVC

PROMOSTOP BASCULANTE TERMOSALDATO
Tilting heat-sealed promo talker



- ▶ COD: CGPSTB0308 D: 8 X 8 cm
- ▶ COD: CGPSTB0408 D: 11 X 8 cm
- ▶ COD: CGPSTB0508 D: 15 X 8 cm
- ▶ COD: CGPSTB0608 D: 18 X 8 cm

Con busta 8 x 8 a bandiera. Materiale: PVC
With 8 x 8 flag envelope. Made of: PVC



PROMOSTOP CON BANDIERA PROMOZIONALE AD INCASTRO
Promo talker with interlocking promotional flag



Prodotto brevettato
 Patented product

Profilo basculante largo/stretto
 con banda siliconica
*Titling large/small profile with
 silicone band*

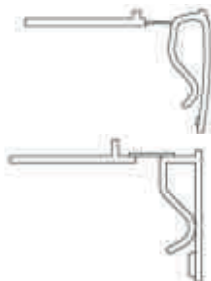
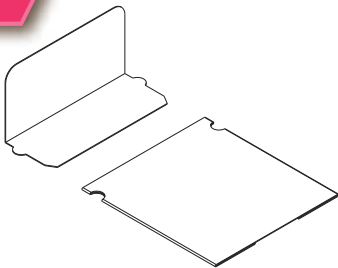

► **COD: CGBITBXX08** D: 8 X 8 cm

Materiale: PPL. Personalizzabile
 Made of: PPL. Customizable

PROMOSTOP CON BANDIERA PROMOZIONALE AD INCASTRO E ATTACCO PORTA BROCHE
Promo talker with interlocking promotional flag and brooch holder

Prodotto brevettato
 Patented product

Profilo porta broche
 Brooch holder profile

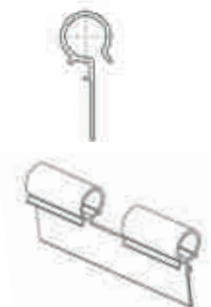
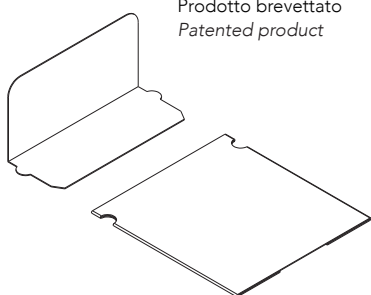

► **COD: CGFITFXX08** D: 8 X 8 cm

Materiale: PPL. Personalizzabile.
 Made of: PPL. Customizable



N. B. : La XX sarà sostituita da un doppio numero che identificherà il prodotto in base alle misure scelte
 Note: The XX will be replaced by a double digit that will identify the chosen product and its size



SUPPLEMENTO PER PROMOSTOP PER ETICHETTE ELETTRONICHE DESTRO O SINISTRO CON ATTACCO A FORO
Supplement for promo talker for right or left electronic labels with hole connection

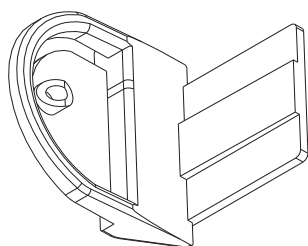

COD: CGALPE0501

Adatto per cartelli con foro da 5mm. Materiale: Pom. Personalizzabile

*Flag-like stopper fit for perpendicular board with 5mm hole
 Made of POM. Customizable*



PROMOSTOP PER ETICHETTE ELETTRONICHE
Promo talker for electronic labels

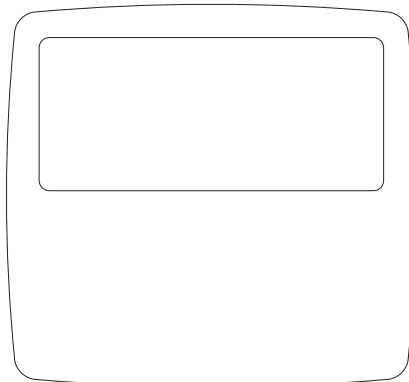

COD: CGPSEEXX99

Disponibile in varie forme e misure. Materiale: PPL. Personalizzabile
Available in various shapes and sizes. Made of: PPL. Customizable



PROMOSTOP AD INCASTRO PER ETICHETTE ELETTRONICHE
Interlocking promo talker for electronic labels

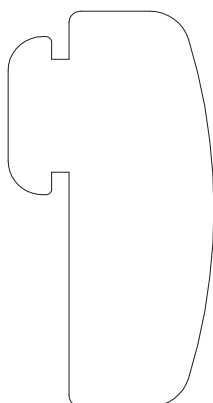

COD: CGPSIEXX99

Disponibile in varie forme e misure. Materiale: PPL. Personalizzabile
Available in various shapes and sizes. Made of: PPL. Customizable



N. B. : La XX sarà sostituita da un doppio numero che identificherà il prodotto in base alle misure scelte
Note: The XX will be replaced by a double digit that will identify the product and its size



PROMOSTOP PER ETICHETTE ELETTRONICHE
 Promo talker for electronic labels

Materiale: PVC



MONOFACCIALE
 Single sided

▶ COD: CGPSDFMXX99

BIFACCIALE
 Double sided

▶ COD: CGPSDFBX99

Disponibile in varie forme e misure.
 Materiale: PPL. Personalizzabile
 Available in various shapes and sizes. Made of: PPL. Customizable.



PROMOSTOP PER ETICHETTE ELETTRONICHE
 Promo talker for electronic labels

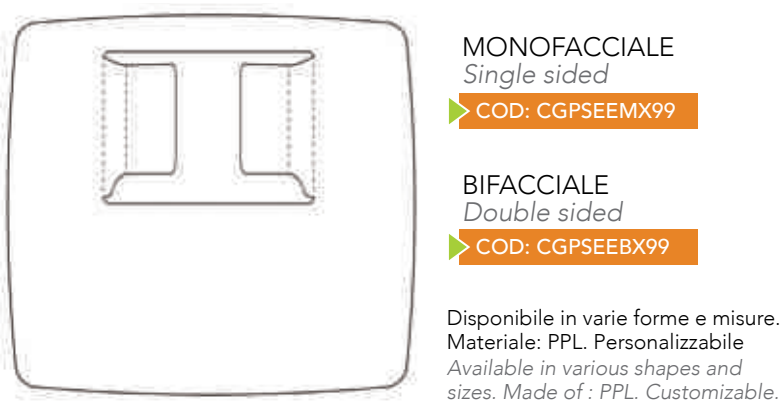

MONOFACCIALE
 Single sided

▶ COD: CGPSEEMX99

BIFACCIALE
 Double sided

▶ COD: CGPSEEBX99

Disponibile in varie forme e misure.
 Materiale: PPL. Personalizzabile
 Available in various shapes and sizes. Made of: PPL. Customizable.



N. B. : La XX sarà sostituita da un doppio numero che identificherà il prodotto in base alle misure scelte
 Note: The XX will be replaced by a double digit that will identify the product and its size

PROMOSTOP PER RIPIANI IN LEGNO
Promo talker for wooden shelves



COD: CGPSWD0208

Materiale: PPL
Made of: PPL



Note: Specify the thickness of the plan and the tag

PROMOSTOP PER RIPIANI IN VETRO
Promo talker for glass shelves



COD: CGPSGL0108

Materiale: PPL
Made of: PPL



Note: Specify the thickness of both shelf and tag

PROMOSTOP PER BOTTIGLIE
Promo talker for bottles

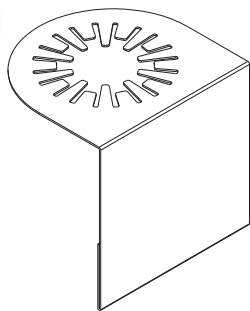

Dimensioni cartellino 8,4 x 5,6 cm.
Materiale: PPL
Size tag 8.4 x 5.6 cm. Made of: PPL

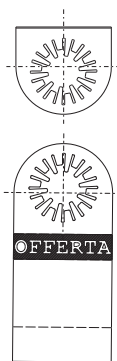

COD: CGPSWN8508

Con scritta "Offerta"
With "Offer" inscription

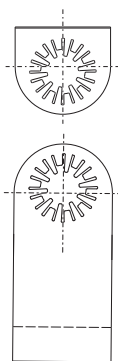

COD: CGPSWN8608

Neutro
Neutral



REALIZZIAMO FORME PERSONALIZZATE PER
QUALSIASI TIPO DI PROMO STOP.

WE MAKE CUSTOMIZED SHAPES FOR ANY KIND OF
PROMO TALKER.



PROMOSTOP FUSTELLATO "OFFERTA"
Pre-printed promo talker "offer"

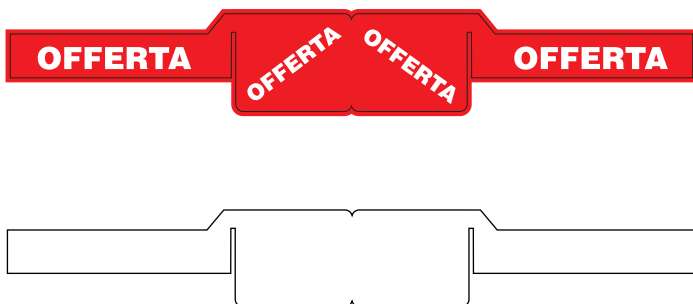

COD: CGPSST0199

Stopper 7,8 x 6,7 cm. Striscia 15 x 3 cm. Misure aperto 46,5 x 6,7 cm. Materiale: PPL
Stopper 7,8 x 6,7 cm. Strip 15 x 3 cm. Size wide open 46.5 x 6.7 cm. Made of: PPL

PROMOSTOP FUSTELLATO "100% BIO"
Pre-printed promo talker "100% bio"

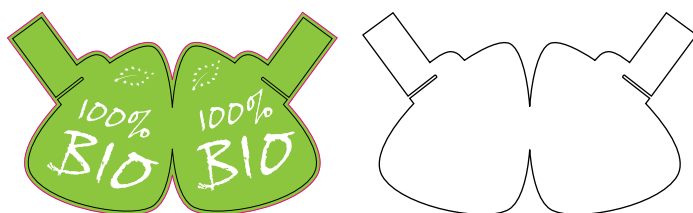

COD: CGPSST0299

Stopper 13 x 16 cm. Striscia 6,7 x 3,2 cm. Misure Aperto 26,3 x 16 cm. Materiale : PPL
Stopper 13 x 16 cm. Strip 6,7 x 3,2 cm. Size wide Open 26.3 x 16 cm. Made of: PPL

PROMOSTOP FUSTELLATO "PREZZO OUTLET"
Pre-printed promo talker "outlet price"

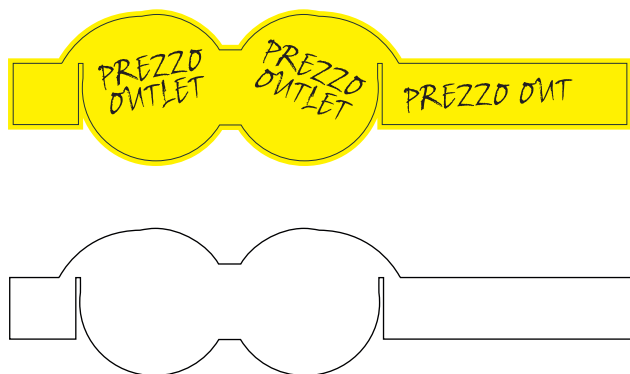

► COD: CGPSST0399

Stopper 9 x 9 cm. Striscia 4/15 x 3,8 cm. Misure aperte 37,6 x 9 cm. Materiale: PPL
Stopper 9 x 9 cm. Strip 4/15 x 3,8 cm. Size wide open 37.6 x 9 cm. Made of: PPL

PROMOSTOP FUSTELLATO "NOVITÀ"
Pre-printed promo talker "new"

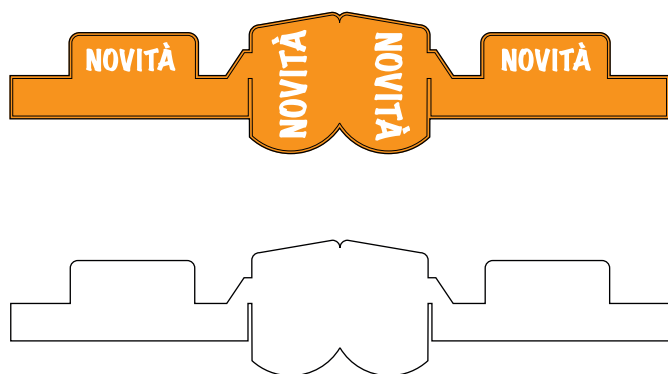

► COD: CGPSST0499

Stopper 9 x 14 cm. Striscia 25 x 3,9 cm. Misure aperte 67,1 x 14 cm. Materiale: PPL
Stopper 9 x 14 cm. Strip 25 x 3,9 cm. Size wide open 67.1 x 14 cm. Made of: PPL

PROMOSTOP FUSTELLATO "GLUTEN FREE"
Pre-printed promo talker "gluten free"

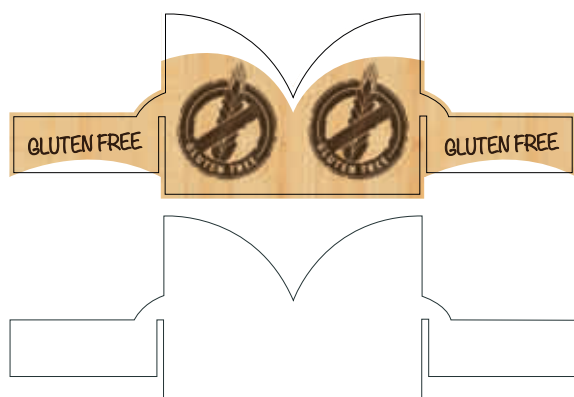

► COD: CGPSST0599

Stopper 8,8 x 12,4 cm. Striscia 10 x 3,9 cm. Misure aperte 38,4 x 12,4 cm. Materiale: PPL
Stopper 8.8 x 12.4 cm. Strip 10 x 3.9 cm. Size wide open 38.4 x 12,4 cm. Made of: PPL



ACCESSORI SUPPORTI PROMOZIONALI

Promotional accessories and holders

▼
COD: CGPS000908



Attacchi promo stop a bandiera per cartelli a profilo perpendicolari. Adatto per cartelli con spessore fino a 3mm. Materiale: PVC
Flag-like promo talker holder for perpendicular boards. Suitable for up-to-3mm labels. Made of: PVC

▼
COD: CGPS001008 D: 1,3 X 2,5 X 1,1 cm



Attacchi promo stop a bandiera per cartelli a profilo perpendicolari con biadesivo. Adatto per cartelli con spessore fino a 3mm. Materiale: PVC
Flag-like promo talker holder for perpendicular bi-adhesive boards. Suitable for up-to-3mm labels. Made of: PVC

▼
COD: CGPS004108



Attacchi promo stop a bandiera per cartelli a profilo perpendicolari. Adatto per cartelli con foro da 5mm. Materiale: PP
Flag-like promo talker holder for perpendicular boards. Suitable for up-to-5mm labels. Made of: PP

▼
COD: CPAACLC101

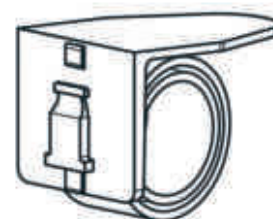

Clip a chiocciola per ripiani con adattatore verticale Materiale: PC + POM. Confezione da 25 pezzi
Spiral clip for shelves with vertical adapter Made of: PC + POM. Pack of 25 pieces



▼
COD: CPAACLC201

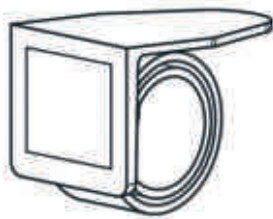

Clip a chiocciola per ripiani con adesivo
Materiale: PC + POM. Confezione da 25 pezzi
Spiral clip for shelves with adhesive. Materiale: AL
Made of: PC + POM. Pack of 25 pcs

▼
COD: CGPSPB0101

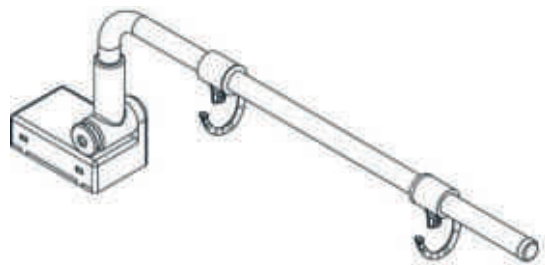

Porta banner orientabile 0-180° a base magnetica. Lunghezza: 27 cm
Materiale: AL
Magnetic 0-180° rotating banner holder. Length: 27 cm. Made of: AL

▼
COD: CGPSHS0401



Attacco a ventosa con pinza porta messaggi snodabile.
Suction cup holder with swiveling tag holder clip..

▼
COD: CMSEGTB108



Gancio Trillo porta blister per ripiani forati passo 25mm.
Lunghezza: 8 cm Materiale: PC
Trillo blister holder hook for 25mm holed shelves. Length: 8 cm. Made of: PC



CORNICI, CAVALLETTI ED ESPOSITORI

Frames, easels and stand displays

Cornici, cavalletti, espositori sono un evergreen che difficilmente sparirà perchè ha dalla sua costo contenuto, affidabilità e versatilità.

Frames, easels, displays are evergreen. They won't disappear as they are cheap, reliable and versatile.

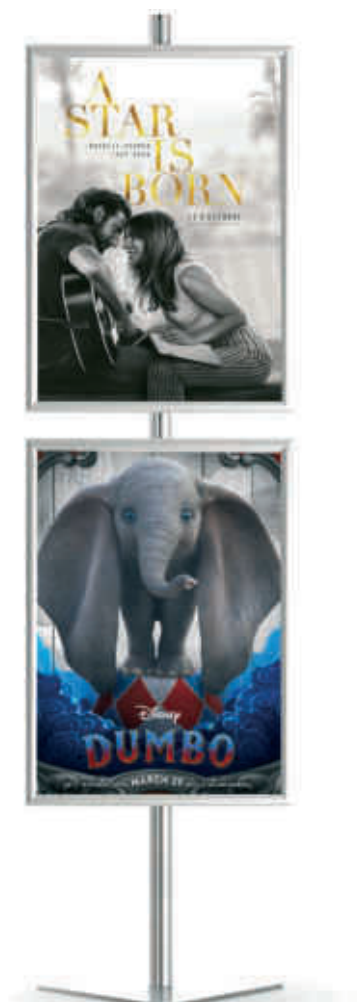

CORNICI IN PLASTICA

Plastic Frames

COLORI :
COLOURS :



▼
COD: CPCRA600

Cornice in plastica con apertura lato corto. Dimensione A6: 10,5 x 14,8 cm. Materiale: ABS
Confezione da 10 pezzi.
Plastic frame with short side opening.
A6 size: 10,5x14,8 cm. Made of: ABS
10 pcs package.

▼
COD: CPCRA500

Cornice in plastica con apertura lato corto. Dimensione A5: 14,8 x 21 cm. Materiale: ABS
Confezione da 10 pezzi.
Plastic frame with short side opening.
A5 size: 14,8x21 cm. Made of: ABS
10 pcs package

▼
COD: CPCRA400

Cornice in plastica con apertura lato corto. Dimensione A4: 21 x 29,7 cm. Materiale: ABS
Confezione da 10 pezzi.
Plastic frame with short side opening.
A4 size: 21x29,7 cm. Made of: ABS
10 pcs package

▼
COD: CPCRA300

Cornice in plastica con apertura lato corto. Dimensione A3: 29,7 x 42 cm. Materiale: ABS
Confezione da 10 pezzi.
Plastic frame with short side opening.
A3 size: 29,7x42 cm. Made of: ABS
10 pcs package.





**EVIDENZIATORE PER CORNICI
COMPLETAMENTE PERSONALIZZABILE**
Completely customizable highlighter for frames

EVIDENZIATORE PER CORNICI "OFFERTA"
Highlighter for frames "Offer"

Orizzontale
Horizontal

Verticale
Vertical

- ▶ COD: CGECA30FHD D: A3
- ▶ COD: CGECA40FHD D: A4
- ▶ COD: CGECA50FHD D: A5

- ▶ COD: CGECA30FVD D: A3
- ▶ COD: CGECA40FVD D: A4
- ▶ COD: CGECA50FVD D: A5



EVIDENZIATORE PER CORNICI "NOVITÀ"
Highlighter for frames "New"

Orizzontale
Horizontal

Verticale
Vertical

- ▶ COD: CGECA3NVHD D: A3
- ▶ COD: CGECA4NVHD D: A4
- ▶ COD: CGECA5NVHD D: A5

- ▶ COD: CGECA3NVVD D: A3
- ▶ COD: CGECA4NVVD D: A4
- ▶ COD: CGECA5NVVD D: A5



ATTACCHI E ACCESSORI PER CORNICI

Holders and accessories for frames

COD: CPAAS02108



Attacco basculante per cornici. Base magnetica. Materiale: PC
 Confezione 10 pezzi.
Tilting holder for frames Magnetic base Made of: PC 10 pcs package.

COD: CPAAPM0108



Pinze a molla con attacco a "T" per cornici. Materiale: PC
 Confezione 10 pezzi.
Spring clip with "T"-shaped holder for frames Made of: PC 10 pcs package.

COD: CPAA000108



Attacco a gancio per cornici. Materiale: PC. Confezione da 10 pezzi
Hook holder for frames . Made of: PC. 10 pcs package.

COD: CPAA000208

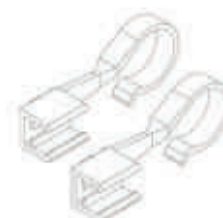

Coppia di ganci per cornici ad uncino. Materiale: PC
 Confezione da 20 pezzi. (10 ganci sx e 10 ganci dx)
*Pair of holders for hook frames. Made of: PC
 20 pcs package (10 left and 10 right hooks).*

COD: CPAA000308

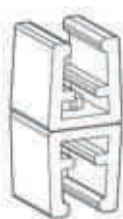

Connettore per cornici. Materiale: PC. Confezione da 10 pezzi.
Clamps for frames. Made of : PC. Pack of 10 pcs.

COD: CPAA174T01



Supporto a gancio con base magnetica.
 Materiale: ABS + Acciaio. Confezione da 10 pezzi.
Hook holder with magnetic base. Made of: ABS + steel 10 pcs package.

COD: CPAAVWC108



Attacco laterale per ceste in filo metallico. Materiale: PC
 Confezione da 20 pezzi. (10 ganci sx e 10 ganci dx)
*Side holder for metal boxes Made of: PC
 20 pcs package (10 left and 10 right hooks).*

COD: CPAA000708

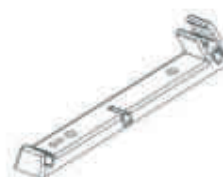

Piedistallo per esposizione cornice inclinata. Materiale: PC
 Confezione da 10 pezzi.
Display stand for inclined frame. Made of: PC 10 pcs package.

COD. : CPAA0017

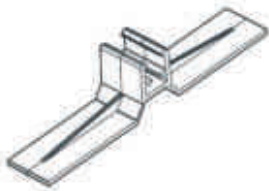

Piedistallo per esposizione cornice verticale. Materiale: PC
Confezione da 10 pezzi.
Vertical frame display stand. Made of: PC. 10 pcs package.

COD. : CPAA007001

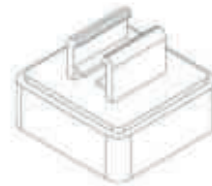

Supporto porta cornice con base magnetica per esposizione a bandiera.
Materiale: ABS + PC Confezione da 10 pezzi.
Magnetic base frame holder for flag-like display. Made of: ABS + PC 10 pcs package.

COD: CPAAT00101



Attacco a "T" orientabile 0-180° con base magnetica.
Materiale: ABS + PC. Confezione da 10 pezzi.
0-180° rotating "T"-shaped magnetic holder Made of: ABS + PC 10 pcs package.

COD: CPAA070B01



Supporto porta cornice con base magnetica per esposizione frontale. Materiale: ABS + PC Confezione da 10 pezzi.
Magnetic base frame holder for front display. Made of: ABS + PC 10 pcs package

COD: CPAAT00308



Attacco a "T" standard per cornici adatto per tutti i tipi di piantane. Materiale: PC Confezione da 10 pezzi.
Made of: PC. Standard "T"-shaped frame holder suitable for all kind of stands. 10 pcs package.

COD: CPAAT00208



Attacco a "T" per cornici orientabile. Materiale: ABS + ST. Confezione da 10 pezzi.
0-180° rotating "T"-shaped frame holder suitable for all kind of stands. Made of: ABS + ST. 10 pcs package.

COD: CGATCSPR08

COD: CPAAHP0008

TASCA ANTIRIFLESSO
Anti-glare pocket

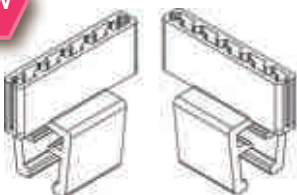

Attacco a cornice per supporti promozionali.
Materiale: PC. Confezione da 10 pezzi.
Frame holder for promotional displays. Made of: PC. Pack of 10 pcs.



Coppia di ganci per braccio supplementare per fogli in PVC. Confezione da 20 pezzi.
Pair of hooks for additional arm for PVC sheets. Pack of 20 pcs.

- ▶ COD: CPAATS0308 D: A3
- ▶ COD: CPAATS0408 D: A4
- ▶ COD: CPAATS0508 D: A5
- ▶ COD: CPAATS0608 D: A6
- ▶ COD: CPAATS0708 D: A7



Materiale: PVC spessore 0,3 mm. Confezione da 10 pezzi.
Made of: 0,3 mm thick PVC. 10 pcs package.

PIANTANE

Free standing base

PIANTANA ECONOMICA CON ATTACCO A "T" ORIENTABILE
Free standing base with adjustable "T" holder



► COD: CPAAES3001 L: da 30 a 60 cm

► COD: CPAAES5001 L: da 50 a 100 cm

Piantana economica base in plastica estensibile con asta e attacco a "T" orientabile 0-180°. Materiale: ABS + AL. Confezione da 10 pezzi
Plastic base upright stand with telescopic bar and 0-180° rotating "T"-shaped holder. Made of: ABS + AL. 10 pcs package.

PIANTANA ECONOMICA CON ATTACCO A "T"
Free standing base with "T" holder



► COD: CPAAEF3001 D: da 30 a 60 cm

► COD: CPAAEF5001 D: da 50 a 100 cm

Piantana economica base in plastica estensibile con asta e attacco a "T" standard. Materiale: ABS + AL. Confezione da 10 pezzi
Plastic base upright stand with telescopic bar and "T"-shaped holder. Made of: ABS + AL. 10 pcs package.

PIANTANA STANDARD CON ATTACCO A "T" ORIENTABILE
Standard free standing base with adjustable "T" holder



► COD: CPAAFS3022 L: da 30 a 60 cm

► COD: CPAAFS5022 L: da 50 a 100 cm

► COD: CPAAFS7522 L: da 75 a 150 cm

Piantana standard base in metallo estensibile con asta e attacco a "T" orientabile 0-180°. Materiale: ABS + AL + FE. Confezione da 10 pezzi
Standard metal base upright stand with telescopic bar and 0-180° rotating "T"-shaped holder. Made of: ABS + AL + Iron. 10 pcs package.

PIANTANA STANDARD CON ATTACCO A "T"
Standard free standing base with "T" holder



► COD: CPAAFF3022 L: da 30 a 60 cm

► COD: CPAAFF5022 L: da 50 a 100 cm

► COD: CPAAFF7522 L: da 75 a 150 cm

Piantana standard base in metallo estensibile con asta e attacco a "T" standard. Materiale: ABS + AL + FE. Confezione da 10 pezzi
Standard metal base upright stand with telescopic bar and "T"-shaped holder. Made of: ABS + AL + Iron. 10 pcs package.

PIANTANA PER CESTI CON ATTACCO A "T" ORIENTABILE
Upright stand for baskets with adjustable "T" holder



► COD: CPAACS3012 L: da 30 a 60 cm

► COD: CPAACS5012 L: da 50 a 100 cm

Piantana per ceste in filo metallico estensibile con asta e attacco a "T" orientabile 0-180°. Materiale: ABS + AL. Confezione da 10 pezzi
Stretchable metal wire box upright stand with bar and 0-180° rotating "T"-shaped holder. Made of: ABS + AL. 10 pcs package.

PIANTANA PER CESTI CON ATTACCO A "T"
Basket free standing base with "T" holder



► COD: CPAACF3012 L: da 30 a 60 cm

► COD: CPAACF5012 L: da 50 a 100 cm

Piantana per ceste in filo metallico estensibile con asta e attacco a "T" standard. Materiale: ABS + AL. Confezione da 10 pezzi
Standard stretchable metal wire box upright stand with bar and "T"-shaped holder. Made of: ABS + AL. 10 pcs package.

▼
COD: CPAAB05012



Braccio supplementare per piantane. Lunghezza: 50 cm. Materiale: AL
Upright stand accessory with extra arm. Length: 50 cm. Made of: AL

▼
COD: CPAAB10012



Braccio supplementare per piantane. Lunghezza: 100 cm. Materiale: AL
Upright stand accessory extra arm. Length: 100 cm. Made of: AL

CORNICI IN ALLUMINIO

Aluminium frames



FOGLIO PROTETTIVO PER CORNICI

Protective frame sheet



Per uso interno
Indoor use

Materiale: PVC antiriflesso
Made of: anti glare PVC

- ▶ COD: CGCAPSB108 D: 50 x 70 cm
- ▶ COD: CGCAPSB208 D: 70 x 100 cm

Per uso esterno
Outdoor use

Materiale: Pet
Made of: Pet

- ▶ COD: CGCAPEB108 D: 50 x 70 cm
- ▶ COD: CGCAPEB208 D: 70 x 100 cm

CORNICE CLICK CLACK 25 CON ANGOLI TONDI

Round-edged click clack 25 frame

CORNICE CLICK CLACK 32 CON ANGOLI TONDI

Round-edged click clack 32 frame



Telaio da 2,5 cm Materiale: AL
2,5 cm frame Made of: AL

Telaio da 3,2 cm Materiale: AL
3,2 cm frame Made of: AL

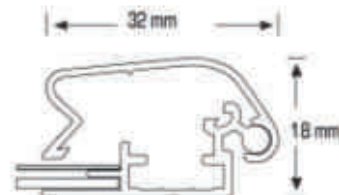
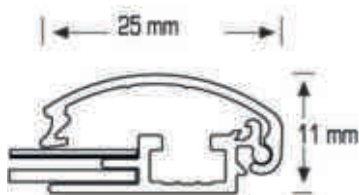

Cornici per uso interno
Frames for indoor use

- ▶ COD: CGCAR20312 D: 50 x 70 cm

Cornici per uso esterno
Frames for outdoor use

- ▶ COD: CGCAE20312 D: 50 x 70 cm

Cornici per uso interno
Frames for indoor use

- ▶ COD: CGCAR30512 D: 70 x 100 cm

Cornici per uso esterno
Frames for outdoor use

- ▶ COD: CGCAE30512 D: 70 x 100 cm

INFO POSTER STAND ANGOLO TONDO
Info poster stand with rounded edges

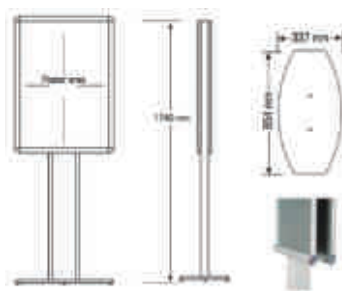

Telaio da 2,5 cm. Materiale: AL + MDF.
Dimensioni: 65,4 X 33,7 X 174 cm
25 cm. Frame. Made of: AL + MDF.
Size: 65,4 X 33,7 X 174 cm

INFO POSTER STAND DOPPIA FACCI
Info Poster Stand double-sided

Per uso interno
For indoor use

➤ COD: CGCARD2012 D: 50 x 70 cm

➤ COD: CGCARD2112 D: 70 x 100 cm

Per uso esterno
For outdoor use

➤ COD: CGCAED2012 D: 50 x 70 cm

➤ COD: CGCAED2112 D: 70 x 100 cm

INFO POSTER STAND SINGOLA FACCI
Info Poster Stand Single Face

Per uso interno
For indoor use

➤ COD: CGCARM2012 D: 50 x 70 cm

➤ COD: CGCARM2112 D: 70 x 100 cm

Per uso esterno
For outdoor use

➤ COD: CGCARE2012 D: 50 x 70 cm

➤ COD: CGCARE2112 D: 70 x 100 cm

CORNICE EASY
Easy Frame



Film trasparente protettivo antiriflesso.
Retro in polistirene grigio.
Transparent anti-glare protective film. Back in grey polystyrene

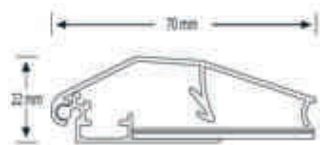

➤ COD: PFSS70050070 D: 50 x 70 cm

➤ COD: PFSS70070100 D: 70 x 100 cm

➤ COD: PFSS70100140 D: 100 x 140 cm

WINDOW FRAME
Window Frame



Fronte retro. Film trasparente protettivo antiriflesso.
Front back. Transparent anti-glare protective film.

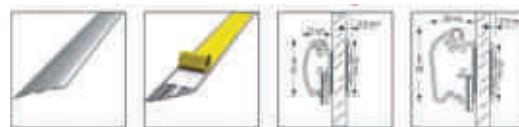

➤ COD: PFSS25021030WF D: 21 x 29,7 cm

➤ COD: PFSS25030042WF D: 29,7 x 42 cm

➤ COD: PFSS25050070WF D: 50 x 70 cm

➤ COD: PFSS25070100WF D: 70 x 100 cm

➤ COD: PFSS25100140WF D: 100 x 140 cm

CAVALLETTI

Easels



CORNICE A CAVALLETTO 32, ANGOLI TONDI CON SCHIENALE IN POLISTIRENE
Easel frame 32, rounded edges with polystyrene back

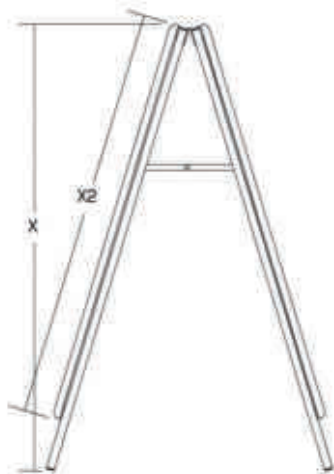

Cornici per uso interno
Frames for indoor use

▶ COD: CGCAAPR012 D: 50 x 70 cm

▶ COD: CGCAAPR112 D: 70 x 100 cm

Cornici per uso esterno
Frames for outdoor use

▶ COD: CGCAEPR012 D: 50 x 70 cm

▶ COD: CGCAEPR112 D: 70 x 100 cm

Telaio da 3,2 cm. Materiale: AL + ST
3.2 cm frame. Material: AL + ST

CHALK BOARD A CAVALLETTO CON CORNICE IN LEGNO
Chalkboard easel with wooden frame

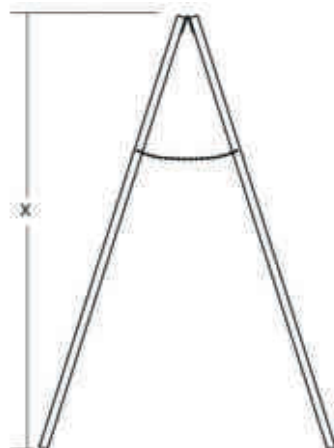

▶ COD: CGCACBW020 D: 66 x 99 cm

Cornice in legno
Wooden frame

POSTER SWING
Swinging Poster

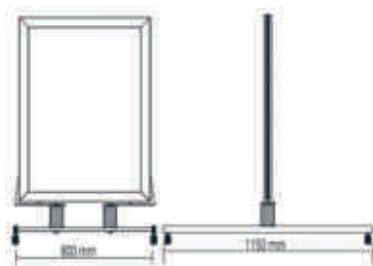

Cornice in alluminio anodizzato 46 mm.
Struttura in metallo con ruote.
46 mm anodized aluminum frame. Metal
frame with wheels.

Cornici per uso interno
Frames for indoor use

- ▶ COD : SWSDR35050070 D: 50 x 70 cm
- ▶ COD : SWSDR35060084 D: 59,4 x 84,1 cm
- ▶ COD : SWSDR35070100 D: 100 x 100 cm
- ▶ COD : SWSDR35084118 D: 84,1 x 118,8 cm

Cornici per uso esterno
Frames for outdoor use

- ▶ COD: SWSDR35050070WP D: 50 x 70 cm
- ▶ COD: SWSDR35060084WP D: 59,4 x 84,1 cm
- ▶ COD: SWSDR35070100WP D: 100 x 100 cm
- ▶ COD: SWSDR35084118WP D: 84,1 x 118,8 cm

CAVALLETTO POLIONDA 1
Corrugated plastic easel 1



- ▶ COD: CAVPO150X70 D: 50 x 70 cm
- ▶ COD: CAVPO170X100 D: 70 x 100 cm
- ▶ COD: CAVPO1100X140 D: 100 x 140 cm

Cavalletto bifacciale leggero in polionda da 10 mm. Materiale: Polionda. Uso interno ed esterno.
Double-sided light easel in 10 mm corrugated plastic. Made of: Corrugated plastic. Indoor and outdoor use.

CAVALLETTO POLIONDA 2
Corrugated plastic easel 2



- ▶ COD: CAVPO250X70 D: 50 x 100 cm
- ▶ COD: CAVPO265X130 D: 65 x 130 cm

Cavalletto bifacciale leggero in polionda da 10 mm. Materiale: Polionda. Uso interno ed esterno.
Double-sided light easel in 10 mm corrugated plastic. Made of: Corrugated plastic. Indoor and outdoor use.

CAVALLETTO VINTAGE
Vintage easel

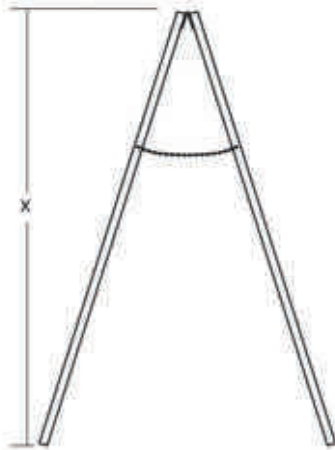

► **COD: AAPFA060084** D: 60 x 84 cm

Struttura in ferro battuto. Piatto decorativo per logo personalizzato. Trasportabile con ruote

Wrought iron structure. Decorative plate for customized logo. Portable with wheels

PORTA INFORMAZIONI AD ANELLI
Stand for ring notebook information



► **COD: CGCARI0012** D: 32 x 90 cm

Formato 2 x A4.
Materiale: AL + STEEL + PMMA

*2 x A4 format.
Made of: AL + STEEL + PMMA*

ESPOSITORI
Displays

ESPOSITORE SUPPORTO PLEXI
Perspex support display



► **COD: SPPLEX6**

Portadepliant a base quadrata con 6 contenitori formato (A4)
Materiale: AL + ST

*Brochure holder square base with 6 containers size (A4)
Made of: AL + ST*

ESPOSITORE SUPPORTO PLEXI
Perspex support display



► **COD: SPPLEX8**

Portadepliant con testata, a base quadrata con 8 contenitori formato (A4)
Materiale: AL + ST

Brochure holder with masthead, square base with 8 containers format (A4). Made of: AL + ST

ESPOSITORE METAL TESTATA
Metal head display



► COD: CGCADB84

Portadepliant con testata, a base quadrata con 8 contenitori formato (A4)
Materiale: AL + ST
*Brochure holder with headmast, square base with 8 containers size (A4)
Made of: AL + ST*

DYNAMIC POSTER STAND
Dynamic poster stand



Monofacciale
Single sided

► COD: CGCAYM0012

Bifacciale
Double sided

► COD: CGCAYB0012

Dynamic Poster Stand singola faccia cornice semplice angoli spigolo vivo, base quadrata. Materiale: AL
Dimensioni: 38 x 207 H cm

*Dynamic Poster Stand single sided frame with sharp edges, square base.
Made of: AL Size: 38 x 207 H cm.*

DYNAMIC POSTER STAND CON PORTA DEPLIANT
Dynamic poster stand with brochure holder



► COD: CGCAYM3012

Dynamic Poster Stand singola faccia con porta depliant (A3), angoli spigolo vivo, base quadrata. Materiale: AL
Dimensioni: 38 x 207 H cm
1 Cornice B2 monofacciale.
1 porta depliant A3.

*Dynamic Single-sided Poster Stand with brochure holder (A3), sharp edges, square base.
Made of: AL
Size: 38 x 207 H cm 1 B2 single-sided frame.
1 A3 brochure holder.*

ESPOSITORE SUPPORTO METALLO
Metal support display stand



► COD: CGCAYM4012

Dynamic Poster Stand doppia faccia con 2 porta depliant (A4), angoli spigolo vivo, base quadrata. Dimensioni : 38 x 297 H cm
Materiale: AL
1 Cornice B2 bifacciale.
2 porta depliant A4

*Double-sided Dynamic Poster Stand with 2 brochure holders (A4), sharp corner angles, square base.
Size: 38 x 297 H cm. Made of: AL
1 double-sided B2 frame.
2 A4 brochure holder.*

► COD: CGCAYD4012

Dynamic Poster Stand doppia faccia con 4 porta depliant (A4), angoli spigolo vivo, base quadrata. Dimensioni : 38 x 297 H cm
Materiale: AL
1 Cornice B2 bifacciale.
4 porta depliant A4

*Dynamic Poster Double-sided Stand with 4 brochure holders (A4), sharp edges, square base.
Size: 38 x 297 H cm. Made of: AL
1 double-sided B2 frame.
4 A4 brochure holder.*



BARRA DOUBLE

Double bar

Aumentano gli accessori per le barre double che rendono queste ultime utilizzabili non solo per applicazioni da soffitto (sia con rulli che con profilo forato), ma anche da pavimento. La nostra stampa digitale permette di usare la barra double anche con supporti per messaggi promozionali.

La combinazione di queste barre (che possiamo tagliare) con i suoi accessori permette di creare strutture sia semplici che complesse e con le dimensioni desiderate. Richiedere informazioni.

Double bar accessories are enriched by a new series of products. Now they can be used not only from the ceiling (both with rollers and perforated profiles), but also on the floor. Our digital printing machine allows the use of our double bar with holders for promotional messages.

The combination of these bars with their accessories (they can be cut to be customized) allows us to create both simple and complex structures with the desired size. Please, ask for any further information.





BARRE Bars

COLORI :
COLOURS :



BARRA DOUBLE CON PROFILO FORATO Double bar with perforated profile



- ▶ COD: CGACBP50
- ▶ COD: CGACBP01
- ▶ COD: CGACBP02
- ▶ COD: CGACBP03

Barra double con profilo forato completa di due terminali. Materiale: AL
Double bar with holed profiles with 2 end caps.
Made of: AL

BARRA DOUBLE CON RULLI Double bar with rollers



- ▶ COD: CGACBR50
- ▶ COD: CGACBR01
- ▶ COD: CGACBR02
- ▶ COD: CGACBR03

Barra double con rulli completa di 2 terminali. Materiale: AL
Double bar with rollers and 2 end caps.
Material:AL

BARRA DOUBLE CON MAGNETI Double bar with magnets



- ▶ COD: CGACBM50
- ▶ COD: CGACBM01
- ▶ COD: CGACBM02
- ▶ COD: CGACBM03

Barra double con magneti per tasca con chiusura metallica. completa di 2 terminali. Materiale:AL
Double bar with pocket magnets with metal closure. Equipped with 2 caps Made of: AL



BASI

Bases

COD: CPAACR3005



Base tonda. Colore nero.
Materiale: FE
Round base. Black colour. Made of: FE

COD: CPAASO3005

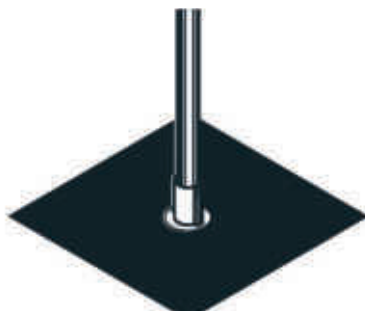

Base quadrata con foro centrale. Colore nero.
Materiale: FE
Square base with central hole. Black colour.
Made of: FE

COD: CPAAYO3005



Base quadrata con foro laterale. Colore nero.
Materiale: FE
Square base with side hole. Black colour. Made of: FE

ESEMPI

Examples.....



Esempio Ponte
Bridge model



Esempio Modello T
Model T

Esempio Modello L
Model L

SUPPORTI

Holders

COD: CPAARL0101

COD: CPAART0101

COD: CPAARB0101



Supporto per base. Colore bianco.
Materiale: ABS
Support for base. White colour.
Made of : ABS



Giunto a T. Colore bianco.
Materiale: ABS
T-joint. White colour.
Made of: ABS



Giunto a L. Colore bianco.
Materiale: ABS
L junction. White colour.
Made of: ABS

TASCHE

Pockets.....



- ▶ COD: CPACV0408 D: A4 VERTICALE
- ▶ COD: CPACO0408 D: A4 ORIZZONTALE
- ▶ COD: CPACV0308 D: A3 VERTICALE
- ▶ COD: CPACO0308 D: A3 ORIZZONTALE

Tasca con chiusura metallica per barra double con calamite.
Pocket with metal closure for double bar with magnets.

ACCESSORI

Accessories

COD: CGACBH0112



Gancio a sospensione per barra. Materiale: FE
Hanging ring hook bar. Made of: FE

COD: CGACBH0212



Giunto lineare per barra. Materiale: FE
Linear coupling bar. Made of: FE

COD: CGACBH0312



Giunto a "V" angolare per barra. Materiale: FE
"V" angular coupling bar. Made of: FE

COD: CGACBH0412



Giunto a "T" per barra. Materiale: FE
"T" coupling bar. Made of: FE

COD: CGACBH0510



Terminale per BARRA DOUBLE
DOUBLE BAR end cap

COD: CGACBH0612



Gancio per fissaggio a parete
Wall mounting holder

COD: CPAAHHS112



Set cavi di sospensione regolabile, con moschettone. Materiale: ST
Threaded adjustable hanging M6 wire set with snap-hook.
Made of: ST

GANCIO METALLICO PER SOSPENSIONE
Metal hook for suspension



L: 10 cm

COD: CPAA010012

L: 15 cm

COD: CPAA015012

L: 30 cm

COD: CPAA030012

L: 50 cm

COD: CPAA050012

L: 70 cm

COD: CPAA070012

L: 100 cm

COD: CPAA100012

COD: CPAAHM0112



Gancio ad "S" in metallo. Materiale: FE
Dimensioni: 39 H mm, Ø 3 mm
Metal "S" hook. Made of: FE Size: 39 H mm,
Ø 3 mm

COD: CPAAHS0312



Gancio per controsoffitto in metallo
Materiale: FE Dimensioni: 32 X 29 mm
Metal countertop hook. Made of: FE
Size: 32 X 29 mm

COD: CPAAHS0201



Gancio per controsoffitto in plastica
trasparente.
Plastic countertop hook.

A person wearing a red sweater and blue jeans is walking away from the camera down a store aisle. They are carrying a red shopping basket filled with items. The aisle is lined with shelves of various products. Another person in a grey sweater is visible in the background, also carrying a shopping basket. The floor is made of light-colored square tiles.

SALES AREA
Accessories



Accessori
AREA VENDITA



COPRI PALLET

Pallet cover

Usare i pallet come piedistalli per l'esposizione dei prodotti è senz'altro una soluzione semplice ed economica.

È difficile però apprezzarne il risultato dal punto di vista estetico. La versatilità dei nostri impianti di stampa e di lavorazione plastiche permette però di scegliere dei COPRI PALLET personalizzabili, anche con piccole quantità, che migliorano enormemente l'impatto visivo e sono, inoltre, estremamente semplici da montare.

Da sottolineare anche che questi contorni plastici possono essere aggiornati periodicamente, ordinando nuove grafiche, in modo da sfruttare queste superfici per le promozioni o altro.

Pallets used as stands for product display represent a simple and cheap solution.

However it can be difficult to appreciate the result of such displays from an aesthetic point of view. But the versatility of our printing and plastic processing machines allows us to choose customizable PALLET COVERS which better the visual impact even with small amounts. Pallets are also extremely easy to assemble.

It should also be remarked that these plastic outlines can be periodically updated, with new graphics, so as to use these surfaces for promotions or other purposes.





CONTORNO PALLET COMPONIBILE CON APERTURA PER CARRELLI ELEVATORI
 Modular pallet outline with opening for forklift trolleys



▶ **COD: AVCPH080** D: 120 x 80 x 80 cm

▶ **COD: AVCPH180** D: 80 x 80 x 80 cm

Materiale: Polionda 3 mm
 Made of: Corrugated plastic 3 mm

CONTORNO PALLET COMPONIBILE
 Modular pallet outline



▶ **COD: AVCPH115** D: 120 x 80 x 150 cm

▶ **COD: AVCPH215** D: 80 x 80 x 150 cm

Chiusura con bottone. Materiale: Polionda 3 mm
 Button closure. Made of: Corrugated plastic 3 mm

CONTORNO PALLET COMPONIBILE
Modular pallet isle

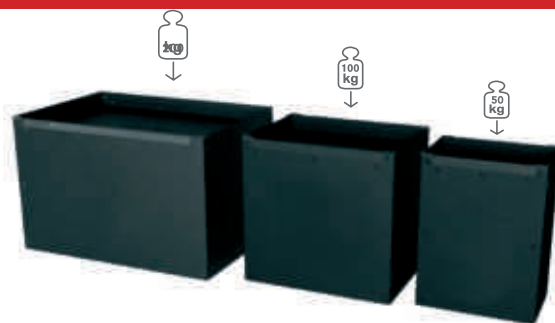

- ▶ **COD: AVPL0122XX** D: 122x82x80 H cm
- ▶ **COD: AVPL0082XX** D: 82x62x80 H cm
- ▶ **COD: AVPL0062XX** D: 62x42x80 H cm

Materiale: Polionda 3 mm
Made of: Corrugated plastic 3 mm

CONTORNO PALLET COMPONIBILE TRIANGOLARE
Triangular modular pallet outline



- ▶ **COD: AVPL0120XX** D: 58 x 69 x 120 H cm
- ▶ **COD: AVPL080XX** D: 58 x 69 x 80 H cm
- ▶ **COD: AVPL050XX** D: 58 x 69 x 50 H cm

Materiale: Polionda 3 mm
Made of: Corrugated plastic 3 mm

CONTORNO PALLET COMPONIBILE ESAGONALE
Modular hexagonal pallet outline



Profondità interna 35 cm
Internal depth 35 cm

- ▶ **COD: AVPL0035XX** D: 50 x 43 x 85 H cm

Profondità interna 15 cm
Internal depth 15 cm

- ▶ **COD: AVPL0015XX** D: 50 x 43 x 85 H cm

Materiale: Polionda 3 mm
Made of: Corrugated plastic 3 mm

N. B. : La XX sarà sostituita da un doppio numero che identificherà il prodotto in base alle misure scelte
Note: The XX will be replaced by a double digit that will identify the product based on the size chosen

ACCESSORI COPRI PALLET

Pallet cover accessories



KIT SEPARATORE 4 SPAZI
Separator kit for 4 areas

SCALETTA PIRAMIDALE
Pyramidal stepladder

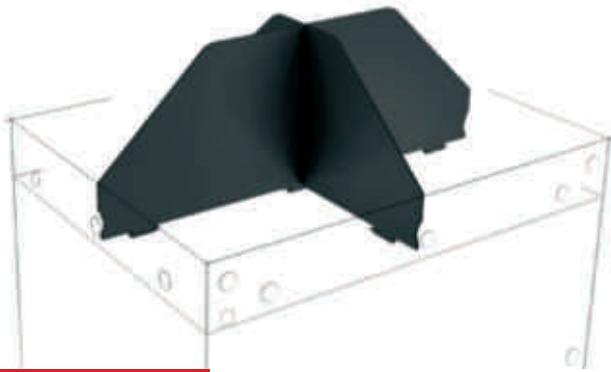

► **COD: AVPL0083XX** D: 83 x 62 x 31,3 H cm

Utile per suddividere in spazi espositivi una superficie piana.
Materiale: Polionda 3 mm
Suitable to divide a flat surface into exhibition spaces.
Made of: Corrugated plastic 3 mm

► **COD: AVPL0081XX** D: 81 x 120 x 96 H cm

Scaletta piramidale a gradini con spazio per comunicazione.
Materiale: Polionda 3 mm
Pyramidal stepladder with insert for communication.
Made of: Corrugated plastic 3 mm

SCALETTA INCLINATA A RIPIANI
Inclined ladder with shelves

SCALETTA PIRAMIDALE
Pyramidal stepladder



► **COD: AVPL0060XX** D: 60 x 80 x 62 H cm

Scaletta inclinata a ripiani. Possibile applicare profili portaprezzo.
Materiale: Polionda 3 mm
Inclined ladder with shelves. Price profiles can be applied.
Made of: Corrugated plastic 3 mm

► **COD: AVPL0062XX** D: 60 x 80 x 62 H cm

Scaletta piramidale a ripiani. Possibile applicare profili portaprezzo.
Materiale: Polionda 3 mm
Pyramidal stepladder with shelves. Price profiles can be applied.
Made of: Corrugated plastic 3 mm

N. B. : La XX sarà sostituita da un doppio numero che identificherà il prodotto in base alle misure scelte
Note: The XX will be replaced by a double digit that will identify the product based on the size chosen

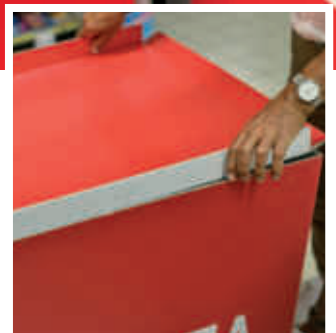
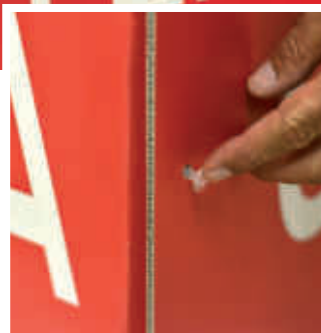
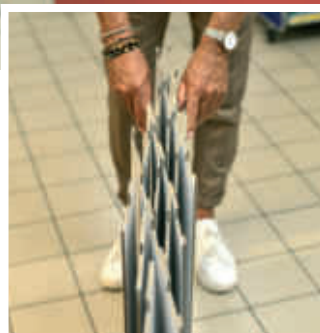

NEW



CUBE

COD : AVCUB806

D: 80 x 60 cm

COD : AVCUB812

D: 80 x 120 cm

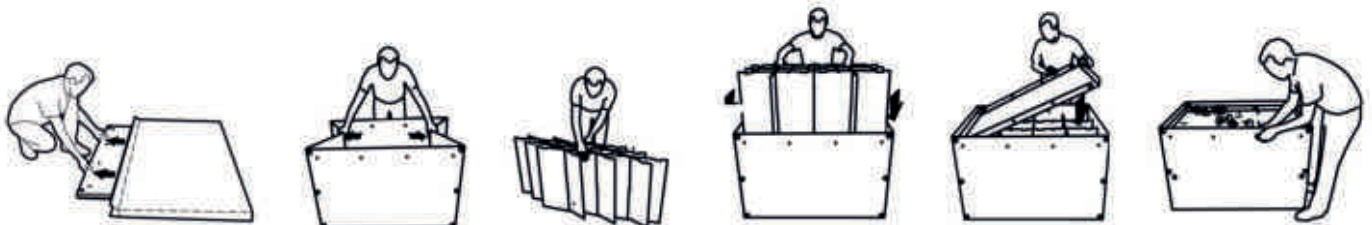

BANCARELLA IN FILO RIPIEGABILE

Stall in foldable wire



Altezza cesta interna 60 cm
Internal basket height 60 cm

▶ COD : SEEP9FR612 D: 60 x 80 x 80 cm

▶ COD : SEEP9FR812 D: 80 x 80 x 80 cm

È possibile richiedere altre dimensioni. Materiale: FE
It is possible to request other sizes. Made of: FE

BANCARELLA IN FILO RIGIDO A GAMBE QUADRE

Hard square-legged wire stall



Altezza cesta interna 60 cm
Internal basket height 60 cm

▶ COD : SEEPGF0812 D: 80 x 80 x 80 cm

▶ COD : SEEPGF1212 D: 120 x 80 x 80 cm

È possibile richiedere altre dimensioni. Materiale: FE
It is possible to request other sizes. Made of: FE

COPRI CESTA IN FILO PERSONALIZZABILE

Customizable wire basket cover



▶ COD: AVPL8060W1 D: 80 x 60 x 80 H cm

▶ COD: AVPL8060W2 D: 80 x 60 x 80 H cm

▶ COD: AVPL8060W3 D: 80 x 60 x 80 H cm

▶ COD: AVPL8060W4 D: 80 x 60 x 80 H cm

Completamente personalizzabili
Fully customizable





MODULI ESPOSITIVI

Display /Exhibition islands

Le isole espositive per l'ortofrutta permettono di presentare i prodotti in modo accattivante e personalizzato. Le isole sono sostanzialmente composte da una base, con ruote o con piedini, da pareti di plastica o di cartone e da un telaio superiore, che può anche essere inclinato, sul quale appoggiare le cassette. Contribuisce all'economicità di questa soluzione la spedizione non assemblata perché il montaggio è estremamente semplice, veloce e affidabile. Ci sono diversi optional che consentono di completare l'esposizione e le pareti possono essere personalizzate con stampe dedicate.



The fruit and vegetable display islands grant an attractive and personalized way to show products. The islands are made of a base, with wheels or feet, with plastic or cardboard walls and with a reclinable upper frame where you can put boxes.

The unassembled shipping packaging contributes to make this solution really cheap. Moreover it is extremely simple, fast and reliable to assemble. There are various options to complete the display and the walls can be customized with tailored prints.



MODULO ESPOSITIVO PIANO PER ORTOFRUTTA CON STAMPA EFFETTO LEGNO

Display module for fruits and vegetables with wooden printing

Modulo in cartone portata max 80 kg
Cardboard display with a max load of 80 kg▶ COD: SEEP40CTEL Piedini 4 cm
Feet 4 cm▶ COD: SEEPWHCTEL Ruote Ø 7,5 cm
Wheels Ø 7,5 cmModulo in plastica portata max 150 kg
Plastic display with a max load of 150 kg▶ COD: SEEP40PLEL Piedini 4 cm
Feet 4 cm▶ COD: SEEPWHPLEL Ruote Ø 7,5 cm
Wheels Ø 7,5 cm

Modulo espositivo per ortofrutta con stampa digitale effetto legno.

Dimensioni: 81,5 x 61,5 x 84,5 H cm.

Fruit and vegetable display system with digitally printed wooden panels.

Size: 81,5 x 61,5 x 84,5 H cm.

MODULO ESPOSITIVO PIANO PER ORTOFRUTTA CON STAMPA EFFETTO FRUTTA

Display module for fruits and vegetables with fruit printing

Modulo in cartone portata max 80 kg
Cardboard display with a max load of 80 kg▶ COD: SEEP40CTFR Piedini 4 cm
Feet 4 cm▶ COD: SEEPWHCTFR Ruote Ø 7,5 cm
Wheels Ø 7,5 cmModulo in plastica portata max 150 kg
Plastic display with a max load of 150 kg▶ COD: SEEP40PLFR Piedini 4 cm
Feet 4 cm▶ COD: SEEPWHPLFR Ruote Ø 7,5 cm
Wheels Ø 7,5 cm

Modulo espositivo per ortofrutta con stampa digitale effetto frutta.

Dimensioni: 81,5 x 61,5 x 84,5 H cm

Fruit and vegetable display system with digitally printed fruit image.

Size: 81,5 x 61,5 x 84,5 H cm

MODULO ESPOSITIVO PIANO PER ORTOFRUTTA CON STAMPA EFFETTO LEGNO IN FOREX

Display module for fruits and vegetables with forex wooden printing

NEW

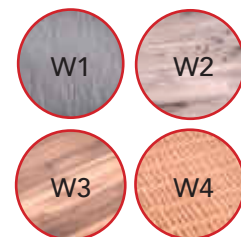
APERTURA MONOFACCIALE
Single sided opening▶ COD: SEEP40FX Piedini 4 cm
Feet 4 cm▶ COD: SEEPWHFX Ruote Ø 7,5 cm
Wheels Ø 7,5 cmAPERTURA BIFACCIALE
Double-sided opening▶ COD: SEEB40FX Piedini 4 cm
Feet 4 cm▶ COD: SEEBWHFX Ruote Ø 7,5 cm
Wheels Ø 7,5 cmModuli espositivi con piano per ortofrutta in forex con stampa digitale personalizzabile.
Dimensioni: 81,5 x 61,5 x 84,5 H cm

Display modules with top for fruits and vegetables in customizable forex by digital printing.

Size: 81,5 x 61,5 x 84,5 H cm

ZIONE

PROMOZIONE

POMODORO OBLUNGO
VASSOIO - 700 G
ITALIA
1,59 al pz.

1,98

POMODORO ROSSO RAFFOLE
VASSOIO - 700 G
ITALIA
1,59

BETOLA
COSTA FINA
ITALIA
1,03
0,99

1,29

0,99

1,45

1,58

1,79

1,19



MODULO ESPOSITIVO INCLINATO PER ORTOFRUTTA CON STAMPA EFFETTO LEGNO
Inclined display module for fruits and vegetables with wooden printing

Modulo in cartone portata max 80 kg
Cardboard display with a max load of 80 kg

▶ **COD: SEEP40CIEL** Piedini 4 cm
Feet 4 cm

▶ **COD: SEEPWHCIEL** Ruote Ø 7,5 cm
Wheels Ø 7,5 cm

Modulo in plastica portata max 150 kg
Plastic display with a max load of 150 kg

▶ **COD: SEEP40PIEL** Piedini 4 cm
Feet 4 cm

▶ **COD: SEEPWHPIEL** Ruote Ø 7,5 cm
Wheels Ø 7,5 cm

Modulo espositivo per ortofrutta con stampa digitale effetto legno.

Dimensioni: 81,5 x 61,5 x 84,5 H cm.

Fruit and vegetable display system with wooden digitally printed panels.

Size: 81,5 x 61,5 x 84,5 H cm.

MODULO ESPOSITIVO INCLINATO PER ORTOFRUTTA CON STAMPA EFFETTO FRUTTA
Inclined display module for fruits and vegetables with fruit printing

Modulo in cartone portata max 80 kg
Cardboard display with a max load of 80 kg

▶ **COD: SEEP40CIFR** Piedini 4 cm
Feet 4 cm

▶ **COD: SEEPWHCIFR** Ruote Ø 7,5 cm
Wheels Ø 7,5 cm

Modulo in plastica portata max 150 kg
Plastic display with a max load of 150 kg

▶ **COD: SEEP40PIFR** Piedini 4 cm
Feet 4 cm

▶ **COD: SEEPWHPIFR** Ruote Ø 7,5 cm
Wheels Ø 7,5 cm

Modulo espositivo per ortofrutta con stampa digitale effetto frutta.

Dimensioni: 81,5 x 61,5 x 84,5 H cm

Fruit and vegetable display system with digitally printed fruit image.

Size: 81,5 x 61,5 x 84,5 H cm

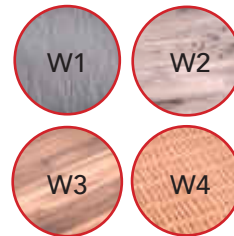
MODULO ESPOSITIVO INCLINATO PER ORTOFRUTTA CON STAMPA EFFETTO LEGNO IN FOREX
Inclined display module for fruits and vegetables with forex wooden printing

▶ **COD: SEMI40FX** Piedini 4 cm
Feet 4 cm

▶ **COD: SEMIWHFX** Ruote Ø 7,5 cm
Wheels Ø 7,5 cm

Modulo espositivo inclinato per ortofrutta in forex con stampa digitale personalizzabile
Dimensioni: 81,5 x 61,5 x 84,5 H cm

Inclined display module for fruits and vegetables in forex with customizable digital printing
Size: 81.5 x 61.5 x 84.5 H cm



CORNICE IN PLASTICA COMPLETA DI ASTA

Plastic frame with rod

COLORI:
COLOURS:



► **COD: SEEPFRA4** D: 21 x 29,7 cm

Kit composto da cornice, asta con attacco a T standard e tasca antiriflesso. Materiale: Al + PL.
Kit includes: frame, rod with standard T-piece and anti-glare pocket. Made of: Al + PL

SUPPORTO INCLINATO PER ESPOSITORE

Inclined support for display



► **COD: SEEPSLT105** D: 81,5 x 61,5 x 4/20 H cm

Materiale: PS
Material: PS

BASE CON PIEDINI

Base with feet



► **COD: SEEPBS4005** D: 80 x 60 H cm

Materiale: PS
Material: PS

BASE CON RUOTE

Base with wheels



► **COD: SEEPBSWH05** D: 80 x 60 H cm

Materiale: PS
Material: PS

BASE PER SUPPORTO INCLINATO CON SPONDA
Base for inclined holder with side panel



Profilo Laterale
Side profile

► **COD: AVPLMI8005** D: 80 x 15 H cm

Materiale: Forex
Made of: Forex



Piano a "L" antiscivolo
Anti-slip "L" flat surface

► **COD: AVPFMI6005** D: 80 x 60 x 15 H cm

Materiale: Forex
Made of: Forex

CONTENITORE PER ESPOSITORE
Display case

PROFILO PORTAPREZZO PER CONTENITORI
Display cases price holder profile



► **COD: AVCTMI1505** D: 80 x 60 x 15 H cm

Materiale: Forex
Made of: Forex

► **COD: CPPR03218008** D: 80 x 4 H cm

PARETE PERSONALIZZABILE
Customizable base

Parete in cartone
Cardboard partition

► **COD: AVMIRN86CBXX**

Parete in plastica
Plastic partition

► **COD: AVMIRN86PBXX**

Parete in forex
Forex partition

► **COD: AVMIRN86FBXX**



La base dei nostri moduli si può personalizzare qualunque sia il materiale di realizzazione scelto.
 Dimensioni: 81,5 x 61,5 x 84,5 H cm

The base of our display systems can be customized with any chosen material.
 Size: 81,5 x 61,5 x 84,5 H cm

N. B. : La XX sarà sostituita da un doppio numero che identificherà il prodotto in base alle misure scelte
Note: The XX will be replaced by a double digit that will identify the product according to the size chosen



ROTOSELLER

Rotoseller

Elegante e funzionale espositore per frutta, verdure e prodotti in promozione. Trova la sua naturale collocazione vicino le isole espositive ma, grazie alle ruote, può essere spostato facilmente in ogni ambiente del punto vendita. La posizione dei tre anelli è regolabile.

Elegant and functional display for fruits, vegetables and products on promotion. Thanks to its wheels can be easily moved to any point of the shop. The position of the three rings is adjustable.



ROTOSELLER CON CESTI IN POLIPROPILENE
Rotoseller with polypropylene baskets



► **COD: SEEPRTC3** D: 60 x 55 x 135 H cm
 Materiale: FE + PP
 Made of: FE + PP

ROTOSELLER CON CIOTOLE IN ABS
Rotoseller ABS bowls



► **COD: SEEPCA03** D: 70 x 65 x 135 H cm
 Materiale: FE + ABS
 Made of: FE + ABS

CESTO CIRCOLARE IN POLIPROPILENE
Polypropylene circular baskets

05 04 17



► **COD: SEEPCT01** D: 45 x 10 H cm
 Materiale: PP
 Made of: PP

CIOTOLA CIRCOLARE IN ABS
ABS circular bowl

05 08



► **COD: SEEPBW03** D: 55 x 18 H cm
 Materiale: ABS
 Made of: ABS

CORNICE A4 PER ROTOSELLER CON ATTACCO A T
A4 frame for rotoseller with t-connection

07



► **COD: SEEPRTA4** D: 29,7 x 21 H cm
 Materiale: ABS + PC
 Made of: ABS + PC



CESTI

Shopping Baskets

Cesti e trolley sono elementi imprescindibili per la maggior parte dei PDV a maggior ragione in questo periodo dove c'è la tendenza alla spesa veloce e quotidiana.

La nostra offerta è veramente ampia e, ancora una volta, si contraddistingue per la flessibilità e la possibilità di personalizzazione lavorando in sinergia con i nostri impianti di stampa e con la nostra officina meccanica.

Cerchiamo anche di intercettare le tendenze del mercato con, ad esempio, i carrelli che permettono l'ingresso anche di cani di piccola taglia. Possibilità di inserire etichette antitaccheggio e placche a seconda delle vostre richieste.

Baskets and trolleys are essential elements for most PDVs, especially nowadays because people are always more and more looking for a fast daily shopping.

Our offer is really wide and once again it stands out for its flexibility and the possibility of customization, thanks to the synergy work with both our printing machines and mechanical workshop.

We try to anticipate and respond to market trends by our trolleys that can carry also small dogs. We can insert anti-theft labels and plates according to specific requests.



GLOBAL TROLLEY, CAPACITÀ 64 LT. IMPILABILE
Stackable Global Trolley, 64 Lt. capacity

COLORI:
 COLOURS:



► **COD: AVSB6401**

D: 48 x 45,5 x 86 cm

Materiale: PP
 Made of: PP

GLOBAL TROLLEY PERSONALIZZATO CON STAMPA SU PVC
Customized trolley with adhesive PVC sheet printing

GLOBAL TROLLEY PERSONALIZZATO CON STAMPA SU PVC
Customized trolley with adhesive PVC sheet printing



Etichetta adesiva in PVC.
 Materiale: PP
 Prodotto personalizzabile.
PVC adhesive label. Made of: PP. Customizable product.



Etichetta adesiva in PVC.
 Materiale: PP
 Prodotto personalizzabile.
PVC adhesive label. Made of: PP. Customizable product.

PORTA INFORMAZIONI PUBBLICITARIE
Advertising information holder

TARGA DI INFORMAZIONE CON STAMPA SERIGRAFICA
Customized plate with silkscreen printing on demand



► **COD: AVSB640608**

D: 20,5 x 21,7 cm



► **COD: AVSB640510**

D: 10,7 x 3,8 cm



N. B. : Le quantità minime ordinabili sono riportate sul listino
 Note: The minimum order quantities are listed on the price list

CARRELLO MAXI TYKO
 Maxi Tyko basket

 COLORI:
 COLOURS:

Il carrello **Maxi Tyko** è:
Ecologico: riciclabile al 100%
Robusto: prodotto interamente in Polipropilene ad alta densità
Maneggevole: può essere utilizzato agevolmente sia a spinta che a traino
Capiente: notevole volume di carico (lt 66)
Espandibile: volume di carico espandibile fino a 99 lt integrandolo con i cestini della linea Tyko
Igienico: Fondo traforato per una facile pulizia.

Maxi Tyko is:
Eco-friendly: 100% recyclable
Strong: entirely made of high density Polypropylene.
Easy-to-use: can easily be used by both pushing and carrying it.
Capacious: large loading volume (lt 66).
Expandable: loading volume expandable up to 99 lt by supplementing it with Tyko line baskets.
Hygienic: holed bottom for easy cleansing

▶ COD: AVSBMXT7

D: 53 x 50 x 94 cm

Carrello Maxi Tyko con 4 ruote, 2 fisse posteriori e 2 piroettanti anteriori. Capacità 66 Lt. Materiale: PP

Maxi Tyko 4wheeled trolley, with 2 rear fixed and 2 front rotating wheels. Capacity: 66 Lt. Made of: PP

CESTO TYKO
 Tyko basket

 COLORI:
 COLOURS:

▶ COD: AVCSTY33

D: 54 x 36,5 x 28 cm

Cesto porta spesa Tyko con manico di colore nero.
 Capacità: 33 Lt. Materiale: PP
 Tyko shopping basket with black handle. Capacity: 33 Lt.
 Made of: PP

CESTO MINI TYKO
 Mini Tyko basket

 COLORI:
 COLOURS:

▶ COD: AVCSMTY2

D: 46,5 x 32,5 x 24 cm

Cesto porta spesa Mini Tyko con manico di colore nero.
 Capacità: 22 Lt. Materiale: PP
 Mini Tyko shopping basket with black handle. Capacity: 22 Lt.
 Made of: PP

COMBINAZIONI PER AUMENTO CAPIENZA

Combinations to increase capacity

 66 Lt.
 + 33 Lt.

 66 Lt.
 + 22 Lt.

COLORI:
COLOURS:



SHOPPING KART CAPACITÀ 60 LT.
Shopping kart capacity 60 lt.



Cesto con 2 ruote
Two wheeled basket

▶ COD: AVSBSK26 D: 40 x 40 x 86,5 cm

Cesto con 4 ruote
Four wheeled basket

▶ CO : AVSBSK46 D: 40 x 40 x 86,5 cm

Materiale: PP
Made of: PP

SHOPPING KART PERSONALIZZATO CON STAMPA SU PVC
Customized shopping kart with pvc print

SHOPPING KART PERSONALIZZATO CON STAMPA SU PVC
Customized shopping kart with pvc print



Etichetta adesiva in PVC.
Materiale: PP
Prodotto personalizzabile.
PVC adhesive label. Made of: PP Customizable product.



Etichetta adesiva in PVC.
Materiale: PP
Prodotto personalizzabile.
PVC adhesive label. Made of: PP Customizable product.



CESTO 21 LT CON DOPPIO MANICO IMPILABILE
 21 lt. stackable basket with double handle

COLORI:

COLOURS:



► **COD: AVCS2121** D: 51 x 35 x 20,7 cm

È possibile personalizzare il cesto con etichetta adesiva in PVC
The basket can be customized with a PVC adhesive label

Cesto 21 litri con doppio manico impilabile. Portata Max. 25 Kg. Materiale: PP
 21 lt. stackable basket with double handle Max. load 25 Kg. Made of: PP

CESTO 27 LT CON DOPPIO MANICO IMPILABILE
 27 litre stackable basket with double handle

COLORI:

COLOURS:



► **COD: AVCS2721** D: 51 x 35 x 27 cm

È possibile personalizzare il cesto con etichetta adesiva in PVC
The basket can be customized with a PVC adhesive label

Cesto 27 litri con doppio manico impilabile portata Max. 25 Kg. Materiale: PP
 27 lt. stackable basket with double handle. Max. 25 Kg. Made of: PP

CESTO 21 LT CON MANICO SINGOLO IMPILABILE
 21 litre stackable basket with single handle

COLORI:

COLOURS:



► **COD: AVCS2101** D: 51 x 35 x 20,7 cm

È possibile personalizzare il cesto con etichetta adesiva in PVC
The basket can be customized with a PVC adhesive label

Cesto 21 litri con manico singolo impilabile portata Max. 25 Kg. Materiale: PP
 21 lt. stackable basket with single handle Max. 25 Kg. Made of: PP

CESTO 27 LT CON MANICO SINGOLO IMPILABILE
 27 litre stackable basket with single handle

COLORI:

COLOURS:



► **COD: AVCS2701** D: 51 x 35 x 27 cm

È possibile personalizzare il cesto con etichetta adesiva in PVC
The basket can be customized with a PVC adhesive label

Cesto 27 litri con manico singolo impilabile portata Max. 25 Kg. Materiale: PP
 27 lt. stackable basket with single handle Max. 25 Kg. Made of: PP



CARRELLO PUPPY
Puppy cart



► **COD : AVCRBKDG12** D: 40 x 80 x 65 H cm

Carrello composto da: 1 carrello con piano d'appoggio bevande, 1 contenitore animale e 1 cesto spesa da 27 lt. Materiale: Fe+ Ps
Trolley made of of: 1 trolley for drinks table, 1 pet container and 1 basket of 27 lt. Made of: Fe + Ps

CARRELLO
Cart



► **COD : AVCRBK0212** D: 40 x 80 x 65 H cm

Carrello composto da: 1 carrello con piano d'appoggio bevande e 2 cesti spesa da 27 lt. Materiale: Fe+ Ps
Cart made of: 1 trolley with drinks shelf e 2 shopping baskets of 27 lt. Made of: Fe + Ps

JOKER PORTA CESTO UNIVERSALE

Joker universal basket holder trolley



► **COD: AVCSJR0112**

D. MAX: 49 x 36 cm
D. MIN.: 40 x 27 cm

Joker porta cesto universale con ruote piroettanti, struttura in metallo regolabile con 5 mm di spessore. Portata max. 65 Kg. Materiale: FE

Joker universal basket trolley holder with rotating wheels and 5 mm thick adjustable metal frame. Max load 65 Kg. Made of: FE



CARRELLO SPESA SPEESY

Speesy shopping basket

COLORI:
COLOURS:



COD: AVSBY45

D: 53 x 41 x 43 cm

Speesy con 2 ruote e manico telescopico
Capacità 45 Lt. Materiale: PP

*Speesy basket with 2 wheels and telescopic handle
Capacity 45 Lt. Made of: PP*

CARRELLO SPESA SPEESY PERSONALIZZATO

Customized Speesy shopping basket



Speesy personalizzato con stampa su etichetta adesiva in PVC 8 x 15 H cm

Speesy customized with a printed adhesive label in PVC 8 x 15 H cm.



STAMPA DIGITALE

Digital Print

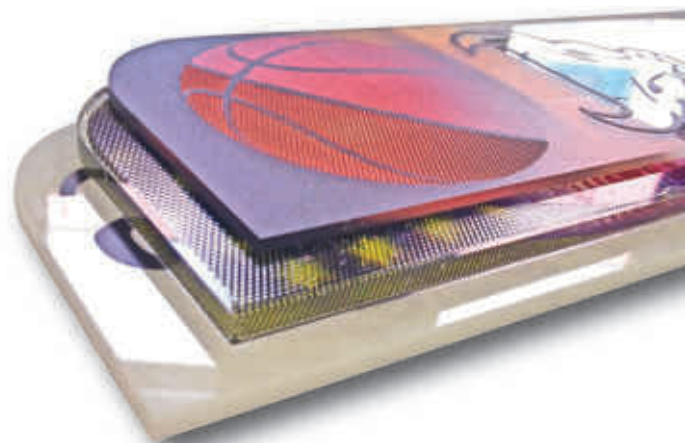
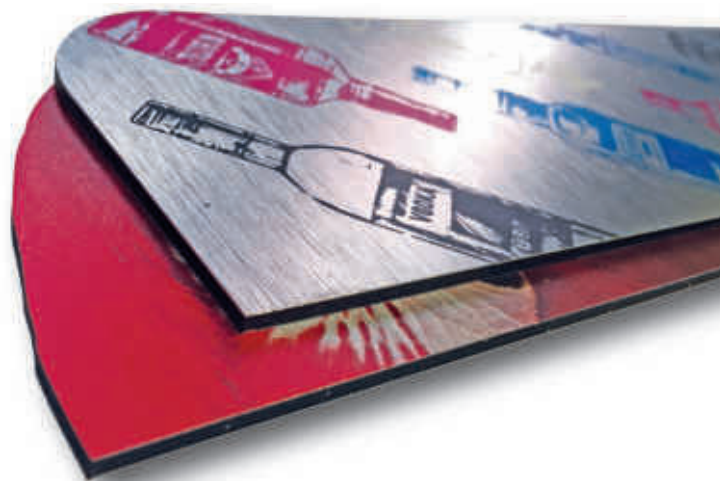

PRODOTTI PERSONALIZZABILI
DIMENSIONI, COLORI, MATERIALI SU MISURA



SEPARATORE VERTICALE
Vertical separator

SEPARATORE VERTICALE
Vertical separator



► **COD: CGPS004108**

Attacchi promo stop a bandiera per cartelli.
Materiale: PP
Flag-like holder for boards.
Made of: PP

► **COD: AVDP000199** D: 8 x 33,5 Hcm
Materiale: PVC. Prodotto personalizzabile
Made of: PVC. Customizable product



► **COD: CGPS004108**

Attacchi promo stop a bandiera per cartelli.
Materiale: PP
Flag-like holder for boards.
Made of: PP

► **COD: AVDP000299** D: 8 x 68 H cm
Materiale: PVC. Prodotto personalizzabile
Made of: PVC. Customizable product

SEPARATORE VERTICALE
Vertical separator

SEPARATORE VERTICALE CIRCOLARE
Round vertical separator



► **COD: CGPS004108**

Attacchi promo stop a bandiera per cartelli.
Materiale: PP
Flag-like holder for boards. Made of: PP

► **COD: AVDP000399** D: 13 x 85 Hcm
Materiale: PVC. Prodotto personalizzabile
Made of: PVC. Customizable product



► **COD: CGPS004108**

Attacchi promo stop a bandiera per cartelli.
Materiale: PP
Flag-like holder for boards. Made of: PP

► **COD: AVDP000499** D: 13 x 85 Hcm
Materiale: PVC. Prodotto personalizzabile
Made of: PVC. Customizable product



STRISCIA PERSONALIZZABILE PER PROFILO PORTAPREZZO
Customizable strip for price holder profile



Realizzato in PVC. Personalizzabile. Altezze variabili in base all'altezza del profilo.
 Made of PVC. Customizable. Variable heights due to the profile height

BANDIERA PROMOZIONALE
Promotional band

BANDIERA PROMOZIONALE
Promotional band



COD: AVDP000699 D: 40 x 20 H cm

Materiale: PVC. Prodotto personalizzabile
 Made of: PVC. Customizable product

COD: AVDP000799 D. base: 27 x 20 H cm
 D. stopper: 32,6 x 17,5 H cm

Materiale: PVC. Prodotto personalizzabile
 Made of: PVC. Customizable product



GATE

Gate



Totem di polipropilene particolarmente adatto per evidenziare sezioni, entrate o promozioni specifiche nel punto vendita. Interamente personalizzabile nel design e nella forma.

Polypropylene totem particularly suitable for highlighting sections, entrances or specific promotions in the store. Fully customizable design and shape.

► COD: AVBGOXLPLP D: 290 x 255 H cm

► COD: AVBGXXLPLP D: 370 x 297 H cm

XL

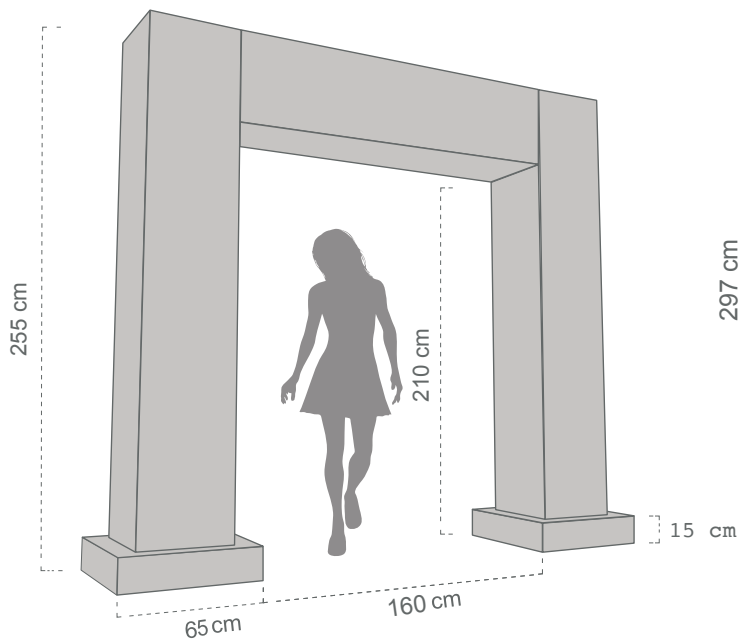

XXL

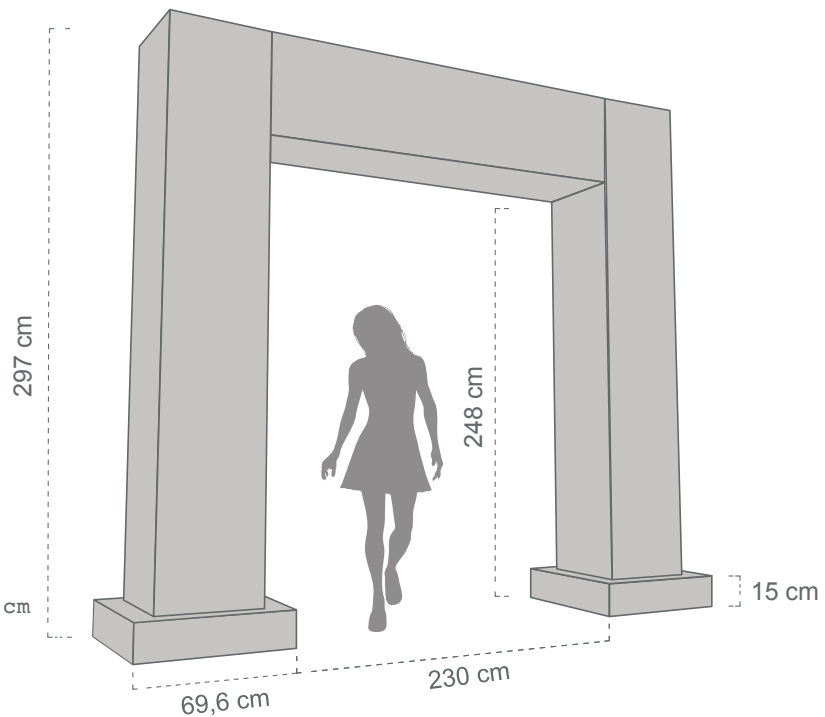

La promozione nei punti vendita non può fare a meno della stampa digitale. Nessuna tecnologia offre lo stesso mix vincente per costi e qualità fotografica delle immagini.

Retail business in store promotion needs digital printing. No other technology offers the same successful combination of cheap costs and high quality photographic image.



AMBIENTAZIONE E COMUNICAZIONE VISIVA AREA VENDITA

Setting and visual communication sales area



TAVOLO RIPIEGABILE "TESTATA"
Foldable communication totem table



▶ **COD: PANODDZ70LP** D: 85,3 x 47,4 x 200 H cm

▶ **COD: PANODDZ90LP** D: 103,4 x 53 x 200 H cm

Tavolo ovale
Oval table

▶ **COD: PANODOV70LP** D: 84,6 x 47,6 x 200 H cm

▶ **COD: PANODOV90LP** D: 103,3 x 56,2 x 200 H cm

Top laminato spessore 18 mm. Ripiano spessore 8 mm. Pannello spessore 3 mm stampabile. Sacca per trasporto inclusa. Non necessita di utensili per l'imballaggio.

18 mm thick laminated top. 8 mm thick shelf. Printable 3 mm thick panel. Equipped with transport bag. No need of packaging tools





CORNICE PROMOZIONALE ESTENSIBILE "OFFERTA"
Extendable promotional frame "offer"

CORNICE PROMOZIONALE
Promotional frame



► **COD: AVCS5080XX** D: L 80 x H estensibile da 50 a 80 cm
D: L 80 x H extendable from 50 to 80 cm
Materiale: Forex 5 mm
Made of: Forex 5 mm

► **COD: AVCD5380XX** D: Variabili
Materiale: Forex 5 mm
Made of: Forex 5 mm

TOTEM MODULARE IN CARTONE
Cardboard modular totem

TOTEM MODULARE IN CARTONE
Cardboard modular totem

COPERTURA ANTITACCHEGGIO
Anti-theft coverage



► **COD: AVCB3030XX** D: 30x30 H cm
Grafica personalizzabile. Materiale: cartone microcanale
Customizable graphics. Made of: corrugated cardboard

► **COD: AVCB4545XX** D: 45x45 H cm
Grafica personalizzabile. Materiale: cartone microcanale
Customizable graphics. Made of: corrugated cardboard

► **COD: AVFGPRSBXX** D: Personalizzate
Grafica personalizzabile. Materiale: cartone microcanale
Customizable graphics. Made of: corrugated cardboard

N. B. : La XX sarà sostituita da un doppio numero che identificherà il prodotto in base alle misure scelte
Note: The XX will be replaced by a double number that will identify the product based on the chosen size.

MOSQUITO
Mosquito



- ▶ **COD: UB197600** D: 210 x 66 x 28,5 cm
- ▶ **COD: UB197** D: 210 x 86 x 28,5 cm
- ▶ **COD: UB196** D: 210 x 91 x 28,5 cm
- ▶ **COD: UB1971000** D: 210 x 106 x 28,5 cm
- ▶ **COD: UB1971200** D: 210 x 126 x 28,5 cm
- ▶ **COD: UB1971500** D: 210 x 156 x 28,5 cm
- ▶ **COD: UB1972000** D: 210 x 206 x 28,5 cm

Mosquito è uno dei nostri best seller.
Disponibile in 7 dimensioni.
Profilo superiore con sistema a scatto.
Piedini stabilizzati e completo di borsa per il trasporto.

*Mosquito is one of our best sellers. Available in 7 sizes.
Upper profile with snap system.
Levelled feet, equipped with transport bag.*



TOTEM COMMUNICATION
Totem Communication



- ▶ **COD: PIUMA60X200** D: 60 x 200 cm
- ▶ **COD: PIUMA75X200** D: 75 x 200 cm
- ▶ **COD: PIUMA100X200** D: 100 x 200 cm
- ▶ **COD: PIUMA100X250** D: 100 x 250 cm
- ▶ **COD: PIUMA100X300** D: 100 x 300 cm

Piedini in communication spessore 20 mm.
Pannello in communication spessore 20 mm.
Disponibile in 5 dimensioni

*20mm thick communication feet.
20mm thick communication panel
Available in 5 sizes.*



BANDIERE

Flags



BANDIERA RETTANGOLARE
Rectangular flag



BANDIERA FEATHER
Feather flag



ASTA IN ALLUMINIO 2,5 CM
POLE IN ALUMINIUM 2,5 CM



ASTA IN GRP
POLE IN GRP

- ▶ **COD: UFZMEXLA** D: 460 x 120 cm
- ▶ **COD: UFZMLA** D: 350 x 110 cm
- ▶ **COD: UFZMME** D: 280 x 90 cm
- ▶ **COD: UFZMSM** D: 210 x 80 cm

- ▶ **COD: UFFLRXL** D: 551 x 82 cm
- ▶ **COD: UFFLRL** D: 450,5 x 82 cm
- ▶ **COD: UFFLRM** D: 350,5 x 72 cm

Realizzate con tubi in alluminio da 2,5 cm.
Veloci e facili da assemblare.
Ampia scelta di basi.
Resistente ai venti fino a 18 mph/ 29 km/h.
Made of 2.5 cm aluminum tubes.
Quick and easy to assemble.
Wide choice of bases.
Resistant to winds up to 18 mph / 29 km / h.



ASTA IN ALLUMINIO 2,5 CM
POLE IN ALUMINIUM 2,5 CM



ASTA IN GRP
POLE IN GRP

- ▶ **COD: UFZMEXLA** D: 460 x 120 cm
- ▶ **COD: UFZMLA** D: 350 x 110 cm
- ▶ **COD: UFZMME** D: 280 x 90 cm
- ▶ **COD: UFZMSM** D: 210 x 80 cm

- ▶ **COD: UFFLFXL** D: 513,5 x 72,5 cm
- ▶ **COD: UFFLFL** D: 419,5 x 67,5 cm
- ▶ **COD: UFFLFM** D: 324,5 x 62,5 cm
- ▶ **COD: UFFLFS** D: 247,5 x 57,5 cm

Realizzate con tubi in alluminio da 2,5 cm.
Veloci e facili da assemblare.
Ampia scelta di basi.
Resistente ai venti fino a 18 mph/ 29 km/h.
Made of 2.5 cm aluminum tubes.
Quick and easy to assemble.
Wide choice of bases.
Resistant to winds up to 18 mph / 29 km / h.

BANDIERA QUILL
Quill flag



ASTA IN ALLUMINIO 2,5 CM
POLE IN ALUMINIUM 2,5 CM



ASTA IN GRP
POLE IN GRP

- ▶ COD: UFMEXLA D: 460 x 120 cm
- ▶ COD: UFZMLA D: 350 x 110 cm
- ▶ COD: UFZMME D: 280 x 90 cm
- ▶ COD: UFZMSM D: 210 x 80 cm

- ▶ COD: UFFLOXL D: 458 x 93 cm
- ▶ COD: UFFLOQL D: 371 x 83,6 cm
- ▶ COD: UFFLOQM D: 286 x 73,4 cm
- ▶ COD: UFFLOQS D: 230 x 62 cm

Realizzate con tubi in alluminio da 2,5 cm.
Veloci e facili da assemblare.
Ampia scelta di basi.
Resistente ai venti fino a 18 mph/ 29 km/h.
Made of 2.5 cm aluminum tubes. Quick and easy to assemble.
Wide choice of bases.
Resistant to winds up to 18 mph / 29 km / h.

TABELLA BASI

Codice	Base per esterno	Base per esterno rotonda	Base quadrata	Base a croce piccola	Base a croce grande	Asta per il terreno	Picchetto	Base in cemento	Base per auto	Nota:
	WD102B	UFZMLWB	UFZMLSQ	UFZMSCB	UFZMLCB	ZFZMGS	UFZMPSS	UFZMCEM	UFZMCF5	
Base										† È necessario l'utilizzo della zavorra e del picchetto da terra †† È necessario l'utilizzo della zavorra
Formulate Lite										
Rettagonolare	Small	N/A	N/A	N/A	N/A	N/A	N/A	N/A	N/A	Zavorra UB719C Picchetto da terra FX620
	Medium	•	•	•†	•†	•†	•	•	•	
	Large		•	•†		•†	•	•	•	
	Extra Large		•	•†		•†	•	•††	•	
Feather	Small	•	•	•†	•†	•†	•	•	•	
	Medium	•	•	•†	•†	•†	•	•	•	
	Large		•	•†		•†	•	•	•	
	Extra Large		•	•†		•†	•	•††	•	
Quill	Small	•	•	•†	•†	•†	•	•	•	
	Medium	•	•	•†	•†	•†	•	•	•	
	Large		•	•†		•†	•	•	•	
	Extra Large		•	•†		•†	•	•††	•	



DISTRIBUTORI GUANTI E SACCHETTI

Dispenser for gloves and bags

Tre proposte che si differenziano per costi, materiali ed estetica. Tutte però ampiamente usate dai nostri clienti.

Three different proposals for costs, materials and aesthetics. All all of them are widely used by our customers.



DISTRIBUTORE GUANTI E SACCHETTI INOX A BASE QUADRATA CON CARTELLO INFORMATIVO
Stainless steel dispenser with information sheet for gloves and bags

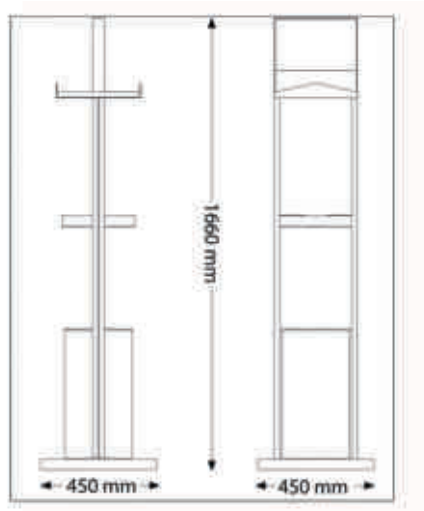

Distributore guanti e sacchetti
Glove and bag dispenser

► **COD: AVDSIX0112** D: 45 x 166 cm

Materiale: STS
Made of: STS

DISTRIBUTORE GUANTI E SACCHETTI COMPLETO DI CORNICE CON CARTELLO INFORMATIVO
Dispenser with information sheet frame for gloves and bags

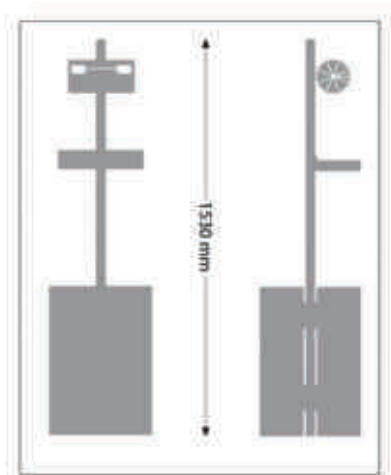

Distributore guanti e sacchetti
Glove and bag dispenser

► **COD: AVDSMG0105** D: 32 x 32 x 153 cm

Porta sacchetti
Bag holder

► **COD: AVDSMG0205**

Porta guanti
Glove holder

► **COD: AVDSMG0305**

Materiale: FE
Made of: FE

DISTRIBUTORE GUANTI E SACCHETTI A BASE QUADRATA SERIE ECO
Square eco series dispenser for gloves and bags



Distributore guanti e sacchetti
Glove and bag dispenser

► **COD: AVDSEC0107** D: 40 x 125 cm

Materiale: FE
Made of: FE

PORTA SACCHETTI PER CASSETTE
Bag holder box

COLORI:
COLOURS:

01 05 07



Porta sacchetti per cassette
Bag holder box

► **COD: AVDSCS0107** D: 40 x 13 X 11 cm

Materiale: FE
Made of: FE



SEPARATORI E SPINGI PRODOTTI

Dividers and product pushers

Utilissimi per avere le pareti con i prodotti ordinati e sempre accessibili. Il feeling che si può trasmettere ai clienti con pareti ben organizzate può essere estremamente positivo e coinvolgente. Sono prodotti solo apparentemente semplici ma che, in realtà, debbono essere adattati al tipo di scaffale e al tipo di prodotto che si vuole esporre. Per questo motivo è necessario proporre diverse soluzioni così come vedrete nelle pagine seguenti. Il nostro reparto tecnico è inoltre a vostra disposizione per verificare insieme quale può essere la soluzione migliore.

Very useful in order to have nicely laid walls with always accessible products. Customers will be cherished by this well-organized atmosphere. These products can be suitably displayed for any kind of shelf or purpose. That's why we studied different solutions that you will appreciate in the following pages. Our technical department is also at your disposal to find out the best solution for all your needs.

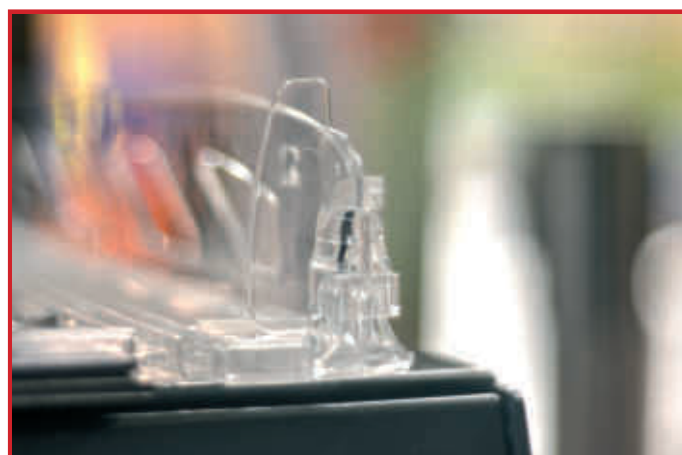

DIVISORI CON SPINGIPRODOTTO

Dividers with product pusher

Per tutte le voci a seguire Prof= depth Stop=stop
Please note:

VASSOIO SPINGIPRODOTTO

Product push tray

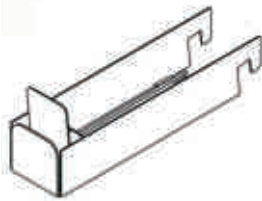

- ▶ **COD: ACSPSS0105** D: Prof. 37,5 cm. Stop 8 cm
- ▶ **COD: ACSPSS0205** D: Prof. 37,5 cm. Stop 15,2 cm
- ▶ **COD: ACSPSS0305** D: Prof. 47,5 cm. Stop 8 cm
- ▶ **COD: ACSPSS0405** D: Prof. 47,5 cm. Stop 15,2 cm
- ▶ **COD: ACSPSS0505** D: Prof. 52 cm. Stop 15,2 cm

Base e divisori laterali in metallo con vernice epossidica. Adatto a prodotti piccoli. Dotato di un supporto per etichette in carta altezza 39 mm.
Base and side partitions in metal with epoxy paint. Suitable for small products. Equipped with a paper label holder 39 mm high

VASSOIO SPINGIPRODOTTO

Product push tray

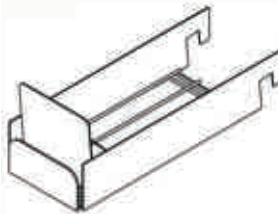

- ▶ **COD: ACSPLS0105** D: Prof. 37,5 cm. Stop 6 cm
- ▶ **COD: ACSPLS0205** D: Prof. 47,5 cm. Stop 6 cm
- ▶ **COD: ACSPLS0305** D: Prof. 52 cm. Stop 6 cm
- ▶ **COD: ACSPLS0405** D: Prof. 56 cm. Stop 6 cm

Base e divisori laterali in metallo con vernice epossidica. Dotato di un supporto per etichette in carta altezza 39 mm.
Base and side partitions in metal with epoxy paint. Equipped with a paper label holder 39 mm high.

VASSOIO SPINGIPRODOTTO DOUBLE

"Double" product push tray

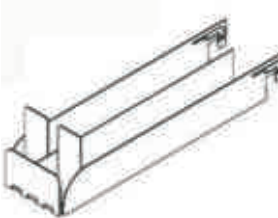
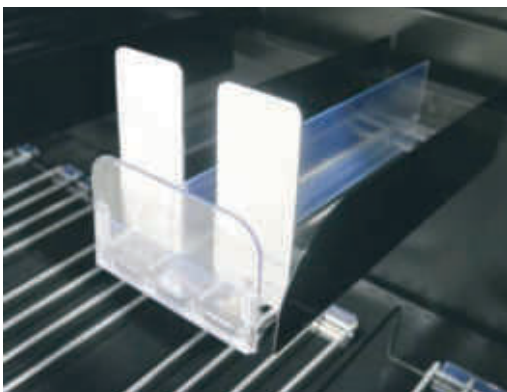

- ▶ **COD: ACSPSD0105** D: Prof. 37,5 cm. Stop 6 cm
- ▶ **COD: ACSPSD0205** D: Prof. 37,5 cm. Stop 8 cm
- ▶ **COD: ACSPSD0305** D: Prof. 47,5 cm. Stop 6 cm
- ▶ **COD: ACSPSD0405** D: Prof. 47,5 cm. Stop 8 cm

Base e divisori laterali in metallo con vernice epossidica. Dotato di un supporto per etichette in carta altezza 39 mm.
Base and side partitions in metal with epoxy paint. Equipped with a paper label holder 39 mm high

VASSOIO SPINGIPRODOTTO

Product push tray



- ▶ **COD: ACSPLD0105** D: Prof. 37,5 cm. Stop 8 cm
- ▶ **COD: ACSPLD0205** D: Prof. 47,5 cm. Stop 8 cm
- ▶ **COD: ACSPLD0305** D: Prof. 56 cm. Stop 8 cm

Base e divisori laterali in metallo con vernice epossidica. Adatto a prodotti di grandi dimensioni. Dotato di un supporto per etichette in carta altezza 39 mm.
Base and side partitions in metal with epoxy paint. Suitable for large products. Equipped with a paper label holder 39 mm high.

SEPARATORE REVERSO

Reverso separator

SEPARATORE REVERSO SMALL

Small reverso separator



- ▶ **COD: SEDVBF2808** D: 28 x 5,5 H cm
- ▶ **COD: SEDVBF3308** D: 33 x 5,5 H cm
- ▶ **COD: SEDVBF3608** D: 36 x 5,5 H cm
- ▶ **COD: SEDVBF3808** D: 38 x 5,5 H cm
- ▶ **COD: SEDVBF4308** D: 43 x 5,5 H cm
- ▶ **COD: SEDVBF4608** D: 46 x 5,5 H cm
- ▶ **COD: SEDVBF4808** D: 48 x 5,5 H cm

Disponibile in varie lunghezze. Si fissa con l'aiuto di un binario anteriore e posteriore. In PET

Available in various lengths. It is fixed by the help of a front and rear track. Made of PET.

SEPARATORE REVERSO MEDIUM

Medium reverso separator



- ▶ **COD: SEDVCF2808** D: 28 x 10 H cm
- ▶ **COD: SEDVCF3308** D: 33 x 10 H cm
- ▶ **COD: SEDVCF3608** D: 36 x 10 H cm
- ▶ **COD: SEDVCF3808** D: 38 x 10 H cm
- ▶ **COD: SEDVCF4308** D: 43 x 10 H cm
- ▶ **COD: SEDVCF4608** D: 46 x 10 H cm
- ▶ **COD: SEDVCF4808** D: 48 x 10 H cm

Disponibile in varie lunghezze. Si fissa con l'aiuto di un binario anteriore e posteriore. In PET

Available in various lengths. It is fixed by the help of a front and rear track. Made of PET

SEPARATORE REVERSO XL

XL reverso separator



- ▶ **COD: SEDVDF2808** D: 28 x 18 H cm
- ▶ **COD: SEDVDF3308** D: 33 x 18 H cm
- ▶ **COD: SEDVDF3608** D: 38 x 18 H cm
- ▶ **COD: SEDVDF3808** D: 43 x 18 H cm
- ▶ **COD: SEDVDF4308** D: 48 x 18 H cm
- ▶ **COD: SEDVDF4608** D: 53 x 18 H cm
- ▶ **COD: SEDVDF4808** D: 58 x 18 H cm

Disponibile in varie lunghezze. Si fissa con l'aiuto di un binario anteriore e posteriore. In PET

Available in various lengths. It is fixed by the help of a front and rear track. Made of PET

SEPARATORE SPEZZABILE

Breakable separator



SEPARATORE SPEZZABILE
Breakable separator



► **COD: SEDVSDW108** D: da 18 a 38 x 3,5 H cm

Spezzabile ogni 2,5 cm.

Si usa con l'ausilio di un binario anteriore e posteriore.

Piastra per binario ad ogni interasse. In PC.

Breakable every 2.5 cm.

To be used with the help of a front and rear track.

Track plate for each wheelbase. Made of PC.

SEPARATORE SPEZZABILE
Breakable separator



► **COD: SEDVSEW108** D: da 18 a 38 x 5,5 H cm

► **COD: SEDVSFW108** D: da 28 a 48 x 5,5 H cm

► **COD: SEDVSGW108** D: da 38 a 58 x 5,5 H cm

Spezzabile ogni 2,5 cm.

Si usa con l'ausilio di un binario anteriore e posteriore.

Piastra per binario ad ogni interasse. In PC.

Breakable every 2.5 cm.

To be used with the help of a front and rear track.

Track plate for each wheelbase. Made of PC.

SEPARATORE SPEZZABILE
Breakable separator

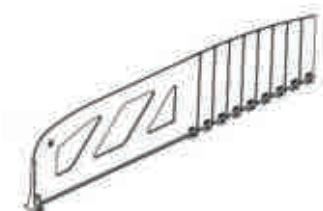

► **COD: SEDVSHW108** D: da 28 a 48 x 10 H cm

► **COD: SEDVSIW108** D: da 38 a 58 x 10 H cm

Spezzabile ogni 2,5 cm.

Si usa con l'ausilio di un binario anteriore e posteriore.

Piastra per binario ad ogni interasse. In PC.

Breakable every 2.5 cm.

To be used with the help of a front and rear track.

Track plate for each wheelbase. Made of PC.

FERMO SEPARATORE

Separator stopper

FERMAPRODOTTO PER SEPARATORE REVERSO SMALL

Product stopper for reverso small separator

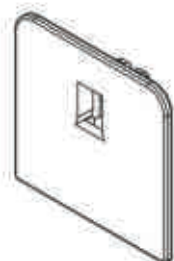

T CENTRALE

Central T

▶ **COD: SEDVFPC108** D: 4 x 3,9 H cm

L SINISTRA E DESTRA

Left and right L

▶ **COD: SEDVFPX108** D: 3,3 x 3,9 H cm

Si fissa sull'aletta anteriore dei separatori REVERSO e spezzabili. In PET.

To be fixed on the front flap of the REVERSO separators and on the breakable ones. Made of: PET.

FERMAPRODOTTO PER SEPARATORE REVERSO MEDIUM

Product stopper for reverso medium separator



T CENTRALE

Central T

▶ **COD: SEDVFPC208** D: 4 x 9 H cm

L SINISTRA E DESTRA

Left and right L

▶ **COD: SEDVFPX208** D: 3,3 x 9 H cm

Si fissa sull'aletta anteriore dei separatori REVERSO e spezzabili. In PET.

To be fixed on the front flap of the REVERSO separators and on the breakable ones. Made of: PET.

FERMAPRODOTTO PER SEPARATORE REVERSO XL

Product stopper for reverso xl separator



T CENTRALE

Central T

▶ **COD: SEDVFPC308** D: 3 x 15 H cm

L SINISTRA E DESTRA

Left and right L

▶ **COD: SEDVFPX308** D: 4 x 15 H cm

Si fissa sull'aletta anteriore dei separatori REVERSO e spezzabili. In PET.

To be fixed on the front flap of the REVERSO separators and on the breakable ones. Made of: PET.

FERMAPRODOTTO PER SEPARATORE REVERSO

Product stopper for reverso separator



T CENTRALE

Central T

▶ **COD: SEDVFPC408** D: 9,9 x 12 H cm

L SINISTRA E DESTRA

Left and right L

▶ **COD: SEDVFPX408** D: 3,3 x 12 H cm

Si fissa sull'aletta anteriore dei separatori REVERSO e spezzabili. In PET.

To be fixed on the front flap of the REVERSO separators and on the breakable ones. Made of: PET.

PROFILO CON BINARIO E ALETTA FERMAPRODOTTO

Profile with track and product stopper flap

PROFILO H. 3 CM
Profile h. 3 cm

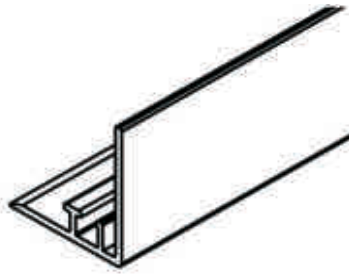

ADESIVO
Adhesive

- ▶ **COD: SEDVF3B008** D: 100 x 2,5 x 3 H cm
- ▶ **COD: SEDVF3B208** D: 124,5 x 2,5 x 3 H cm
- ▶ **COD: SEDVF3B408** D: 132,5 x 2,5 x 3 H cm

MAGNETICO
Magnetic

- ▶ **COD: SEDVF3M008** D: 100 x 2,5 x 3 H cm
- ▶ **COD: SEDVF3M208** D: 124,5 x 2,5 x 3 H cm
- ▶ **COD: SEDVF3M408** D: 132,5 x 2,5 x 3 H cm

PROFILO H. 4 CM
Profile h. 4 cm



ADESIVO
Adhesive

- ▶ **COD: SEDVF4B208** D: 124,5 x 6 x 4 H cm
- ▶ **COD: SEDVF4B408** D: 132,5 x 6 x 4 H cm

MAGNETICO
Magnetic

- ▶ **COD: SEDVF4M208** D: 124,5 x 6 x 4 H cm
- ▶ **COD: SEDVF4M408** D: 132,5 x 6 x 4 H cm

PROFILO H. 6 CM
Profile h. 6 cm



ADESIVO
Adhesive

- ▶ **COD: SEDVF6B208** D: 124,5 x 4 x 6 H cm
- ▶ **COD: SEDVF6B408** D: 132,5 x 4 x 6 H cm

MAGNETICO
Magnetic

- ▶ **COD: SEDVF6M008** D: 100 x 4 x 6 H cm
- ▶ **COD: SEDVF6M208** D: 124,5 x 4 x 6 H cm
- ▶ **COD: SEDVF6M408** D: 132,5 x 4 x 6 H cm

PROFILO H. 8 CM
Profile h. 8 cm



ADESIVO
Adhesive

- ▶ **COD: SEDVF8B208** D: 124,5 x 6 x 8 H cm
- ▶ **COD: SEDVF8B408** D: 132,5 x 8 H cm

MAGNETICO
Magnetic

- ▶ **COD: SEDVF8M208** D: 124,5 x 6 x 8 H cm
- ▶ **COD: SEDVF8M408** D: 132,5 x 6 x 8 H cm



ALETTA FERMAPRODOTTO CON PROFILO
Product stopper with profile wing

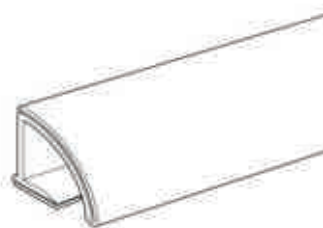

ADESIVO BIANCO
White adhesive

▶ **COD: CPPRSGT41301** D: 132,5 x 3 H cm

MAGNETICO BIANCO
White magnetic

▶ **COD: CPPRSGM41301** D: 132,5 x 3 H cm

BASE ARROTONDATA CON BINARIO PER DIVISORI
Rounded base with track for dividers



ADESIVO BIANCO
White adhesive

▶ **COD: SEDVGAB201** D: 124,5 x 3 H cm

▶ **COD: SEDVGAB401** D: 132,5 x 3 H cm

MAGNETICO BIANCO
White magnetic

▶ **COD: SEDVGAM201** D: 124,5 x 3 H cm

▶ **COD: SEDVGAM401** D: 132,5 x 3 H cm

MAGNETICO NERO
Black magnetic

▶ **COD: SEDVGAM205** D: 66 x 3 H cm

▶ **COD: SEDVGAM405** D: 99,5 x 3 H cm

▶ **COD: SEDVGAM605** D: 132,5 x 3 H cm

PROFILO
Profile

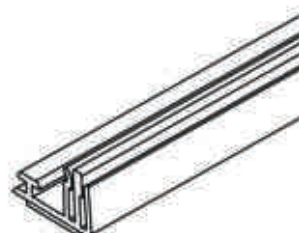

ADESIVO
Adhesive

▶ **COD: SEPCCG1T08** D: 99,5 x 1 H cm

▶ **COD: SEPCCG2T08** D: 132,5 x 1 H cm

MAGNETICO
Magnetic

▶ **COD: SEPCCG2M08** D: 132,5 x 1 H cm



PROFILO

Profile

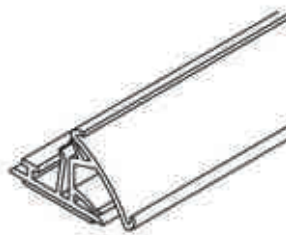

ADESIVO
Adhesive

▶ **COD: AVPRBN13AD** L: 132,5 H cm

MAGNETICO
Magnetic

▶ **COD: AVPRBN13MG** L: 132,5 H cm

PROFILO

Profile

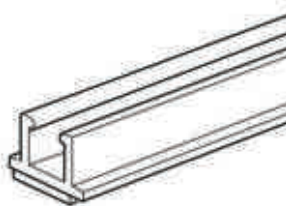

ADESIVO
Adhesive

▶ **COD: AVBNRGD099** D: 99,5 x 1 H cm

▶ **COD: AVBNRGD133** D: 133 x 1 H cm

SISTEMI DI FISSAGGIO

Fixing systems

SISTEMI DI FISSAGGIO

Fixing system

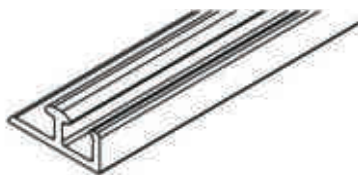

ADESIVO Adhesive

- ▶ **COD: SEDVB10001** D: 100 x 1,6 H cm
- ▶ **COD: SEDVB12401** D: 124,5 x 1,6 H cm
- ▶ **COD: SEDVB13201** D: 132,5 x 1,6 H cm

MAGNETICO Magnetic

- ▶ **COD: SEDVM10001** D: 100 x 1,6 H cm
- ▶ **COD: SEDVM12401** D: 124,5 x 1,6 H cm
- ▶ **COD: SEDVM13301** D: 132,5 x 1,6 H cm

SISTEMI DI FISSAGGIO

Fixing system

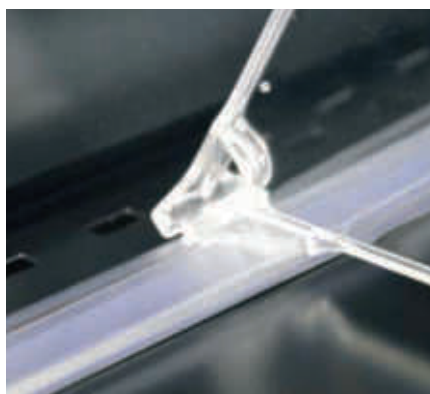

MAGNETICO Magnetic

- ▶ **COD: SEDVPM0108** D: 100 x 1,8 H cm
- ▶ **COD: SEDVPM0208** D: 124,5 x 1,8 H cm
- ▶ **COD: SEDVPM0408** D: 132,5 x 1,8 H cm

SISTEMI DI FISSAGGIO

Fixing system



ADESIVO Adhesive

- ▶ **COD: SEDVF10001** D: 100 x 5,5 H cm
- ▶ **COD: SEDVF13301** D: 133 x 5,5 H cm

SISTEMI DI FISSAGGIO

Fixing system

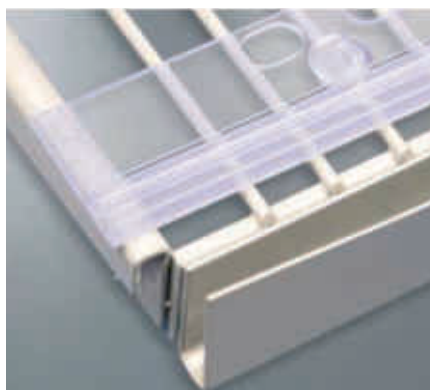

RAIL Rail

- ▶ **COD: SEDVAF0208** D: 124,5 x 3 H cm



CLIP Clip

- ▶ **COD: SEDVAFCL08** D: Ø 1,2 H cm

CREMAGLIERE

Racks

SPINGIPRODOTTO A STRISCIA DI AVANZAMENTO (TIRETTE)

Sliding forward system (pullers)

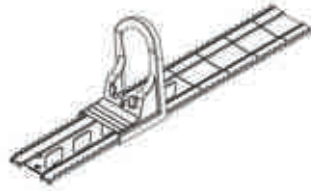
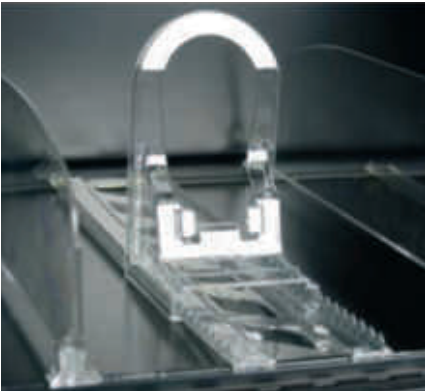

► **COD: SEDVSP02KT08** D: da 28 a 48 x 7 H cm

Progettato per dare ai prodotti una migliore visibilità. Scala in PC, cavalletto in PET.

Designed to give better visibility to products. PC scale, PET easel.

SPINGIPRODOTTO A STRISCIA DI AVANZAMENTO (TIRETTE)

Sliding forward system (pullers)



► **COD: SEDVSP04KT08** D: da 33 a 58 x 9 H cm

Progettato per dare ai prodotti una migliore visibilità. In PC.

Designed to give better visibility to products. Made of PC

SPINGIPRODOTTO

Product feed



► **COD: AVSP12402308** D: 6 x 12 H cm

Progettato per dare ai prodotti una migliore visibilità. In PET.

Designed to emphasize products display. Made of PET.

SPINGIPRODOTTO BASE MAGNETICA

Sliding forward system with magnetic base

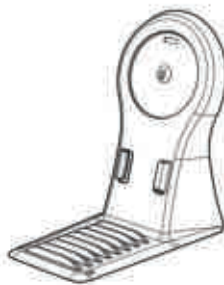

► **COD: AVSP12421108** D: 15,2 x 14 H cm

Progettato per dare ai prodotti una migliore visibilità. Magnetico, si poggia sullo scaffale di metallo. In PC con base magnetica.

Designed to emphasize products display. Magnetic, it has to be laid on a metal shelf. Made of PC Magnetic base.

ACCESSORI PER CREMAGLIERA

Racks accessories

MAXI SCHIENALE

Maxi backrest



▶ **COD: AVAS12410508** D: 10,5 x 15 H cm

▶ **COD: AVAS12410708** D: 10,5 x 21 H cm

Progettato per espandere le dimensioni del cavalletto e mantenere prodotti di grandi dimensioni. In PET. Accessorio per prodotto con il seguente codice:
- AVSP12420308

*Designed to enlarge the size of the easel and hold large products. Made of PET. Accessory for following code item:
- AVSP12420308*

MAXI SCHIENALE SPINGIPRODOTTO

Product feed maxi backrest



▶ **COD: SEDVSA0108** D: 13 x 18 H cm

Progettato per espandere le dimensioni del cavalletto e mantenere prodotti di grandi dimensioni. In PET. Accessorio per prodotti con i seguenti codici:
- SEDVSP02KT08
- SEDVSP01KT08
- AVSP12421108

*Designed to enlarge the size of the easel and hold large products. Made of PET. Accessory for following code items:
- SEDVSP02KT08
- SEDVSP01KT08
- AVSP12421108*

REGOLATORE MANUALE

Manual regulator



▶ **COD: SEDVSA0208** D: da 33 a 57 H cm

Progettato per facilitare l'avanzamento dei prodotti. In PC. Accessorio per prodotti con i seguenti codici:
- SEDVSP02KT08
- SEDVSP01KT08

*Designed to ease product feed. Made of PC
Accessory for following code items:
- SEDSP02KT08
- SEDSP01KT08*

SPINGIPRODOTTO A MOLLA

Product pusher with spring

SPINGIPRODOTTO A MOLLA PER TAVOLETTE DI CIOCCOLATO

Product pusher with spring for chocolate bars

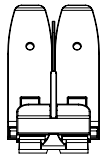

CENTRALE
Central

▶ COD: AVSPMC9N08

P: 9 N Progettato per mantenere intatto il prodotto e facilitarne la presa. Da completare con la guida di fissaggio. In PC.

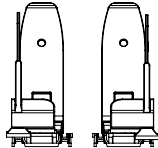

DESTRO O SINISTRO
Right or left

▶ COD: AVSPML9N08

P: 9 N

Designed to preserve the product integrity and help easy pick it up from shelf. To be completed with installation track. Made of PC.

SPINGIPRODOTTO A MOLLA SMALL FIN SINGOLO

Single smallfin product pusher with spring

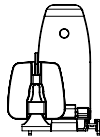

CENTRALE
Central

▶ COD: AVSPMSFC9N08

P: 9 N Progettato per mantenere intatto il prodotto e facilitarne la presa. Da completare con la guida di fissaggio. In PC.

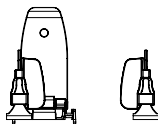

DESTRO O SINISTRO
Right or left

▶ COD: AVSPMSFL9N08

P: 9 N

Designed to preserve the product integrity and help easy pick it up from shelf. To be completed with installation track. Made of PC.

SPINGIPRODOTTO A MOLLA SMALL SINGOLO

Single smallfin product pusher with spring

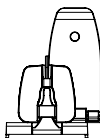

CENTRALE
Central

▶ COD: AVSPAMSC9N08

P: 9 N Progettato per mantenere intatto il prodotto e facilitarne la presa. Da completare con la guida di fissaggio. In PC.

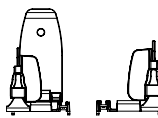

DESTRO O SINISTRO
Right or left

▶ COD: AVSPAMSL9N08

P: 9 N

Designed to preserve the product integrity and help easy pick it up from shelf. To be completed with installation track. Made of PC.

SPINGIPRODOTTO A MOLLA SMALL DOPPIO

Single smallfin product pusher with spring

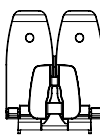

CENTRALE
Central

▶ COD: AVSPMSDC9N08

P: 9 N Progettato per mantenere intatto il prodotto e facilitarne la presa. Da completare con la guida di fissaggio. In PC.

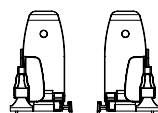

DESTRO O SINISTRO
Right or left

▶ COD: AVSPMSDL9N08

P: 9 N

Designed to preserve the product integrity and help easy pick it up from shelf. To be completed with installation track. Made of PC.

SPINGIPRODOTTO A MOLLA MEDIUM SINGOLO

Medium single product pusher with spring

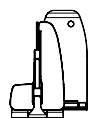

CENTRALE
Central

▶ **COD: AVSMMSC09N08**

P: 9 N

▶ **COD: AVSMMSC18N08**

P: 18 N

Progettato per mantenere intatto il prodotto e facilitarne la presa. Da completare con la guida di fissaggio. In PC.

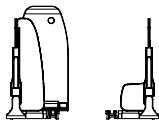

DESTRO O SINISTRO
Right or left

▶ **COD: AVSMMSL09N08**

P: 9 N

▶ **COD: AVSMMSL18N08**

P: 18 N

Designed to preserve the product integrity and help easy pick it up from shelf. To be completed with installation track. Made of PC.

SPINGIPRODOTTO A MOLLA MEDIUM DOPPIO

Medium double product pusher with spring

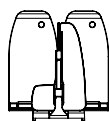

CENTRALE
Central

▶ **COD: AVSMMDC09N08**

P: 9 N

▶ **COD: AVSMMDC18N08**

P: 18 N

Progettato per mantenere intatto il prodotto e facilitarne la presa. Da completare con la guida di fissaggio. In PC.

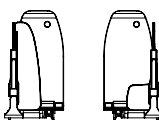

DESTRO O SINISTRO
Right or left

▶ **COD: AVSMMDL09N08**

P: 9 N

▶ **COD: AVSMMDL18N08**

P: 18 N

Designed to preserve the product integrity and help easy pick it up from shelf. To be completed with installation track. Made of PC.

ACCESSORI PER SPINGIPRODOTTO A MOLLA
Accessories for product pusher with spring

SUPPORTO INCLINATO PER SPINGIPRODOTTO A MOLLA MEDIUM

Inclined support for medium product pusher with spring

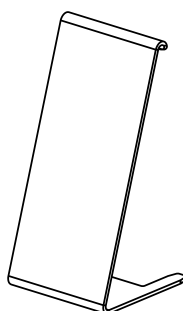

▶ **COD: AVACSPSI08**

D: 5 x 10,5 H cm

Progettato per sorreggere imballaggi piatti. In PET.

Designed to hold flat packaging. Made of PET.

GUIDA DI FISSAGGIO

Fixing guide

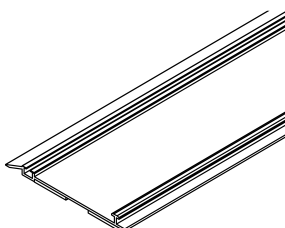

MAGNETICO
Magnetic

▶ **COD: AVASPGFM1108**

D: 100 cm

▶ **COD: AVASPGFM1208**

D: 124,5 cm

▶ **COD: AVASPGFM1308**

D: 132,5 cm

ADESIVO
Adhesive

▶ **COD: AVASPGFA1308**

D: 132,5 cm

Progettato per tutti i modelli di spingiprodotto a molla.

Designed for all spring driven models



ACCESSORI

Accessories

Questo settore raccoglie una serie di prodotti che non appartengono alle stesse famiglie ma sono comunque essenziali nella quotidianità di molti PDV. I prodotti che troverete sono quelli che più ci sono stati richiesti fino ad ora o che riteniamo più utili in base alle nostre esperienze. In parte sono di nostra produzione ma anche quelli che commercializziamo provengono da aziende affidabili con le quali collaboriamo da anni e che ci permettono di offrire la giusta qualità.

This sector collects a series of products that do not belong to the same category; nevertheless they are essential in everyday's life of many retail businesses. Here we include our most requested products or the ones usually valued as the most useful, based on our experience. We produce (some of them) while others are products we sell on behalf of reliable companies we have been working with for years and which allow us to offer high quality standards.



TAGLIERE IN POLIETILENE DA BANCO CON FERMI
Polyethylene chopping board for stands with stopping supports



Altri formati e colori su richiesta. Materiale: PE
Other sizes and colours on request. Made of: PE

Altezza 2 cm
Height 2 cm

- ▶ **COD: AVAVCB02001** D: 40 x 30 x 2 H cm
- ▶ **COD: AVAVCB12001** D: 50 x 40 x 2 H cm
- ▶ **COD: AVAVCB22001** D: 60 x 40 x 2 H cm
- ▶ **COD: AVAVCB32001** D: 70 x 40 x 2 H cm
- ▶ **COD: AVAVCB42001** D: 80 x 40 x 2 H cm

Altezza 2,5 cm
Height 2,5 cm

- ▶ **COD: AVAVCB02501** D: 40 x 30 x 2,5 H cm
- ▶ **COD: AVAVCB12501** D: 50 x 40 x 2,5 H cm
- ▶ **COD: AVAVCB22501** D: 60 x 40 x 2,5 H cm
- ▶ **COD: AVAVCB32501** D: 70 x 40 x 2,5 H cm
- ▶ **COD: AVAVCB42501** D: 80 x 40 x 2,5 H cm

Altezza 3 cm
Height 3 cm

- ▶ **COD: AVAVCB03001** D: 40 x 30 x 3 H cm
- ▶ **COD: AVAVCB13001** D: 50 x 40 x 3 H cm
- ▶ **COD: AVAVCB23001** D: 60 x 40 x 3 H cm
- ▶ **COD: AVAVCB33001** D: 70 x 40 x 3 H cm
- ▶ **COD: AVAVCB43001** D: 80 x 40 x 3 H cm

FILMATRICE MANUALE IN ACCIAIO INOX
Stainless steel manual taping machine



▶ **COD: AVAVHW4031**

Lunghezza max. rotolo: 40 cm.
 Dimensioni: 50 x 61 x 13,5 H cm.
*Roll max. length: 40 cm.
 Size: 50 x 61 x 13,5 H cm.*

▶ **COD: AVAVHW4531**

Lunghezza max. rotolo: 45 cm.
 Dimensioni: 55 x 61 x 13,5 H cm.
*Roll max. length: 45 cm.
 Size: 55 x 61 x 13,5 H cm.*

N. B. : Disponibile su richiesta anche filmatrice manuale a freddo.
N. B.: Available cold stainless steel manual taping machine on request

BATTICARNE IN ACCIAIO INOX
Stainless steel meat tenderizer



▶ **COD: AVAVMT1531**

Peso: 1.5 Kg
Weight: 1.5 Kg

▶ **COD: AVAVMT2031**

Peso: 2.0 Kg
Weight: 2.0 Kg

STERILIZZATRICE PER COLTELLI
Stainless steel knife sterilizer



▶ **COD: AVAVSC0031**

Capacità: oltre 14 coltelli.
Capacity: more than 14 knives.

GUANTO IN MAGLIA IN ACCIAIO INOX
Stainless steel mesh glove

- ▶ **COD: AVAVGSXS31** **Taglia : XS (verde)**
Size : XS (green)
- ▶ **COD: AVAVGS0S31** **Taglia : S (bianco)**
Size : S (white)
- ▶ **COD: AVAVGS0M31** **Taglia : M (rosso)**
Size : M (red)
- ▶ **COD: AVAVGS0L31** **Taglia : L (blu)**
Size : L (blue)
- ▶ **COD: AVAVMT2031** **Taglia : XL (arancio)**
Size : XL (orange)

GUANTO IN MAGLIA CON MANICOTTO IN ACCIAIO INOX
Sleeved stainless steel mesh glove

- ▶ **COD: AVAVGLXS31** **Taglia : XS (verde)**
Size : XS (green)
- ▶ **COD: AVAVGL0S31** **Taglia : S (bianco)**
Size : S (white)
- ▶ **COD: AVAVGL0M31** **Taglia : M (rosso)**
Size : M (red)
- ▶ **COD: AVAVGL0L31** **Taglia : L (blu)**
Size : L (blue)
- ▶ **COD: AVAVGLXL31** **Taglia : XL (arancio)**
Size : XL (orange)

FORBICI IN ACCIAIO INOX
Stainless steel scissors

▶ **COD: AVAVSC0031** L : 23 cm

TRINCIAPOLLO IN ACCIAIO INOX
Stainless steel poultry shears

▶ **COD: AVAVPS0031** L : 25 cm

MORSA PER PROSCIUTTO
Vice for ham

▶ **COD: AVMPLCFE**

BARRA MAGNETICA APPENDI COLTELLI
Magnetic bar for hanging knives

▶ **COD: AVBACM5012** L : 50 cm

SPAZZOLA PULISCI FORNO
Oven cleaning brush



▶ **COD: AVAFSP0108** L: 110 cm

ROTELLA PIZZA
Pizza wheel



▶ **COD: AVRPO50617** D : Ø 10 cm

APRISCATOLE
Can opener



▶ **COD: AVASTT3360**

ALZATA CON COPERCHIO IN VETRO
Riser with glass lid



▶ **COD: AVAB661208** D : Ø 32 x 28 H cm

N.B.: Articolo vendibile con componenti separate.
Note: Item sold with separate components.

VASCHEE INOX SERIE GASTRONORM
Gastronorm stainless steel tray series



Coperchi
Lids

- ▶ **COD: AVBCG11712** D : 1/1
- ▶ **COD: AVBCG11812** D : 1/2
- ▶ **COD: AVBCG11912** D : 1/3
- ▶ **COD: AVBCG12012** D : 1/4

- ▶ **COD: AVBCG10112** D : 1/1 H 65 cm
- ▶ **COD: AVBCG10212** D : 1/1 H 100 cm
- ▶ **COD: AVBCG10312** D : 1/1 H 150 cm
- ▶ **COD: AVBCG10412** D : 1/1 H 200 cm
- ▶ **COD: AVBCG10512** D : 1/2 H 65 cm
- ▶ **COD: AVBCG10612** D : 1/2 H 100 cm
- ▶ **COD: AVBCG10712** D : 1/2 H 150 cm
- ▶ **COD: AVBCG10812** D : 1/2 H 200 cm

- ▶ **COD: AVBCG10912** D : 1/3 H 65 cm
- ▶ **COD: AVBCG11012** D : 1/3 H 100 cm
- ▶ **COD: AVBCG11112** D : 1/3 H 150 cm
- ▶ **COD: AVBCG11212** D : 1/3 H 200 cm
- ▶ **COD: AVBCG11312** D : 1/4 H 65 cm
- ▶ **COD: AVBCG11412** D : 1/4 H 100 cm
- ▶ **COD: AVBCG11512** D : 1/4 H 150 cm
- ▶ **COD: AVBCG11612** D : 1/4 H 200 cm

N.B.: Disponiamo di vaschette gastronorm anche in policarbonato e polietilene. Richiedere informazioni
Note: Also available polycarbonate and polyethylene gastronorm trays. Please request information.



CLIENTE SUCCESSIVO

BARRA " CLIENTE SUCCESSIVO"
"Next Customer" bar

BARRA " CLIENTE SUCCESSIVO"
"Next Customer" bar



CLIENTE SUCCESSIVO



Cliente successivo

► COD: AVAVBCS101 L : 25 cm

► COD: AVAVBCS105 L : 25 cm

BARRA " CASSA CHIUSA"
"Checkout lane closed" bar

BARRA PERSONALIZZABILE CON APERTURA SUPERIORE
Customizable bar with top opening



CASSA CHIUSA



CASSA CHIUSA

► COD: AVAVBCC105 L : 23 cm

► COD: AVAVBP0108 L : 25 cm

CARRELLO PORTA TEGLIE
Tray trolley



► COD: AVCP3T12

Carrello porta teglie 4 ruote, adatto per teglie 60 x 40 cm, GN1/1 e GN1/2.

Tray trolley with 4 wheels, suitable for 60 x 40 cm, GN1 / 1 and GN1 / 2 trays.

CONTABANCONOTE

Banknote counter

▶ **COD: AVAVCB61**

Contabanconote con controllo di banconote false, è un dispositivo di nuova concezione e di avanzata tecnologia. Effettua operazioni di conteggio e verifica con controllo magnetico su tutte le banconote attualmente in uso.

Banknote counter with banknote checking system. It is a newly-designed and hi-tech device. It makes magnetic counting and checking of all currently used banknotes.

VERIFICA BANCONOTE CON BATTERIA RICARICABILE

Banknote check unit with rechargeable battery

▶ **COD: AVAVSXB1**

Il verifica banconote è solido e compatto, ottimo per essere collocato nei banchi cassa. Rapidità, affidabilità e facilità di utilizzo ne fanno uno strumento ideale per ogni attività commerciale. Completo di batteria ricaricabile.

This banknote check unit is sound and compact and can be easily placed in the cash point. It is fast, efficient and easy-to-use and, thus, it is perfect for any kind of business. With rechargeable battery.

VERIFICA BANCONOTE CON SOLA ALIMENTAZIONE VIA CAVO

Banknote check system with cable power only.

▶ **COD: AVAVSXWB**

Verifica banconote con sola alimentazione via cavo.
Banknote check system with cable power only.

SIGILLA SACCHETTI CON LAMA DI RIFILO

Bags sealer with trimming blade

**ROTOLI PER SIGILLA SACCHETTI**

Bag sealer tape rolls

COLORI/ COLOURS:

▶ **COD: AVDSSB0102** L : 25 cm**COD: AVDSRSB1** L : 0,9 cm

BIDONE CON PEDALE DA 120 LT
120 Lt bin with pedal

COLORI/ COLOURS:



COD: ALBPB120

D : 48 x 48 x 93 H cm

BIDONE CON PEDALE DA 80 LT
80 Lt bin with pedal

COLORI/ COLOURS:



COD: ALBPB080

D : 48 x 48 x 93 H cm

BIDONE INDUSTRIALE AD USO ALIMENTARE IN POLIETILENE
Polyethylene industrial food grade bin

Banda adesiva in pvc di colore verde per bidone industriale
Green PVC adhesive strip for industrial bin

Bidone industriale
Industrial bin

- ▶ COD: AVBCB07501 Cap : 75 Lt. D : 48 x 57 cm
- ▶ COD: AVBCB10001 Cap : 100 Lt. D : 52 x 67 cm
- ▶ COD: AVBCB15001 Cap : 150 Lt. D : 62 x 71 cm

Coperchi per bidoni
Lids for bins

- ▶ COD: ALBCC07501 Cap : 75 Lt.
- ▶ COD: ALBCC10001 Cap : 100 Lt.
- ▶ COD: ALBCC15001 Cap : 150 Lt.

Banda adesiva in pvc
PVC adhesive band

- ▶ COD: AVBCA07507 Cap : 75 Lt.
- ▶ COD: AVBCA10007 Cap : 100 Lt.
- ▶ COD: AVBCA15007 Cap : 150 Lt.

PLEXIWORLD



Plexiworld

PORSCHE DESIGN

GIORGIO ARMANI

PRADA

TOM FORD

CHANEL

bin
klich!



PLEXIGLASS

Perspex

Questo materiale esalta al massimo le nuove capacità produttive e progettuali del nostro gruppo. La sua eleganza, stampabilità e duttilità lo hanno reso uno dei materiali di elezione dei designer. Con i nostri reparti grafici, di ingegneria e con i nuovi impianti di stampa e di taglio/piegatura siamo in grado di dare concretezza a tutte le vostre idee. Per questo motivo le pagine dedicate a questo settore vanno sfogliate anche per avere spunti per nuove idee e personalizzazioni. Possiamo inoltre utilizzare, in alcuni casi, lastre certificate per il contatto con gli alimenti.

This material maximizes the new production and design skills of our group. Its elegance, printability and adaptability makes it the material designers choose most. With our graphic and engineering departments and the new printing, cutting and bending systems we can convert all your ideas into concrete products. The following pages should be read in order to get new customizable ideas. Whenever needed we can use certified plates for food contact.



PRODOTTI PERSONALIZZABILI
 DIMENSIONI, COLORI, MATERIALI SU MISURA



ENOTECA Wine shop

PORTA SECCHIELLO DA RINGHIERA
Railing bucket holder

► COD: PWENPL0199

Materiale: Policarbonato trasparente spessore 5 mm.
Prodotto personalizzabile.
*Made of: 5 mm thick transparent polycarbonate.
Customizable product.*

PORTA SECCHIELLO CON ASOLE PER BICCHIERI DA VETRO E RINGHIERA
Bucket holder with slots for glasses and rails

► COD: PWENPL0299

Materiale: Plexiglass spessore 8 mm. Prodotto personalizzabile.
Made of: Perspex thickness 8 mm. Customizable product

PORTA BICCHIERI DA PARETE
Wall glass holder

► COD: PWENPL0399

Materiale: Plexiglass spessore 8 mm. Prodotto personalizzabile.
Made of: Perspex thickness 8 mm. Customizable product.

PORTA BICCHIERI E BOTTIGLIA DA PARETE
Wall holder both for glasses and bottles

► COD: PWENPL0499

Materiale: Plexiglass spessore 6 mm. Prodotto personalizzabile.
Made of: Perspex thickness 6 mm. Customizable product.

PRODOTTO PERSONALIZZABILE
CONFEZIONATO IN ITALIA



PORTABOTTIGLIE 6 FORI
Bottle holder 6 holes

▶ **COD: PWENPL0599**

Materiale: Plexiglass spessore 6 mm. Prodotto personalizzabile.

Made of: Perspex thickness 6 mm. Customizable product.



PORTABOTTIGLIE 6 FORI
Bottle holder 6 holes

▶ **COD: PWENPL0699**

Materiale: Plexiglass spessore 6 mm. Prodotto personalizzabile.

Made of: Perspex thickness 6 mm. Customizable product.

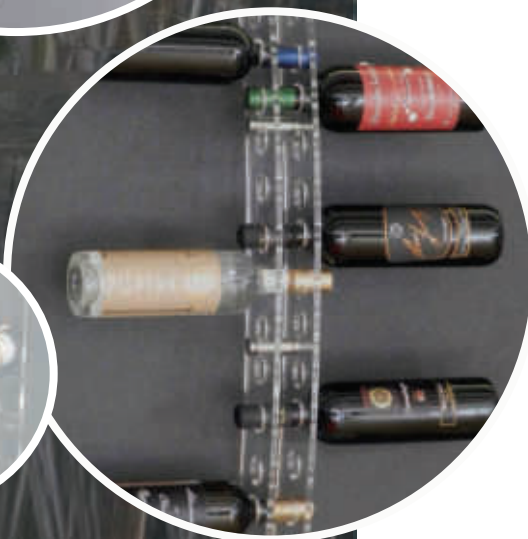

PORTABOTTIGLIE 12 FORI
Bottle holder 12 holes

▶ **COD: PWENPL0799**

Materiale: Plexiglass spessore 6 mm. Prodotto personalizzabile.

Made of: Perspex thickness 6 mm. Customizable product.



PORTABOTTIGLIE E BICCHIERI
Rack for bottles and glasses

▶ **COD: PWENPL0899**

Materiale: Plexiglass spessore 6 mm. Prodotto personalizzabile.

Made of: Perspex thickness 6 mm. Customizable product.



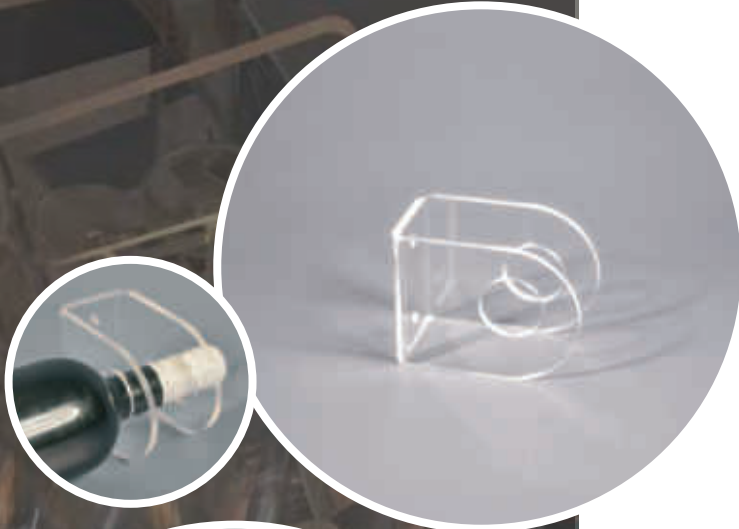

PORTABOTTIGLIE A MURO
Wall bottle holder

► **COD: PWENPL0999**

Materiale: Plexiglass spessore 6 mm. Prodotto personalizzabile.

Made of: Perspex thickness 6 mm. Customizable product.



PORTABOTTIGLIE IN FOREX
Forex bottle holder

► **COD: PWENPL1099**

Materiale:Forex spessore 20 mm. Prodotto personalizzabile.

Made of: Forex thickness 20 mm. Customizable product.



PORTA BICCHIERI RETTANGOLARE
Rectangular glass holder

► **COD: PWENPL1199**

Materiale: Plexiglass spessore 8 mm. Prodotto personalizzabile.

Made of: Perspex thickness 8 mm. Customizable product.



PORTA BICCHIERI CIRCOLARE
Round glass holder

► **COD: PWENPL1299**

Materiale: Plexiglass spessore 8 mm. Prodotto personalizzabile.

Made of: Perspex thickness 8 mm. Customizable product.

PRODOTTO PERSONALIZZABILE
PRODOTTI PERSONALIZZABILI

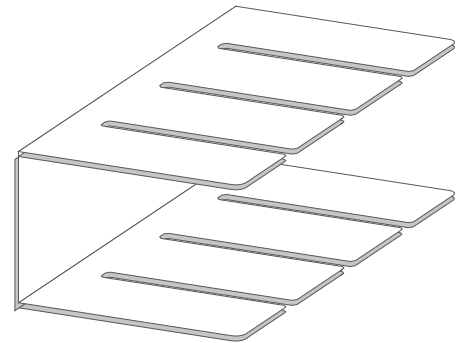

PERSONALIZZAZIONE SENZA LIMITI
ENDLESS CUSTOMIZATION



PRODOTTI PERSONALIZZABILI
www.plexiglass.it



COPRITAVOLO
Table cover

► **COD: PWENPL1599**

Materiale: Policarbonato spessore 5 mm. Prodotto personalizzabile.
Made of: Perspex thickness 5 mm. Customizable product.



**PORTABICCHIERI PER APERITIVO
DA VETRO O RINGHIERA**
Cocktail glass holder for railing

► **COD: PWENPL1699**

Materiale: Plexiglass spessore 5 mm. Prodotto personalizzabile.
Made of: Perspex thickness 5 mm. Customizable product.



PORTA FINGER FOOD
Finger food holder

► **COD: PWENPL1799**

Materiale: Plexiglass spessore 5 mm. Prodotto personalizzabile.
Made of: Perspex thickness 5 mm. Customizable product.



PASTICCERIA E GELATERIA

Pastry and ice-cream shop

PORTACONI
Cone holders

▶ COD: PWPGPL0199

Materiale: Plexiglass spessore 5 mm. Prodotto personalizzabile.

Made of: Perspex thickness 5 mm. Customizable product



TAGLIERE CONI
Cone chopping board

▶ COD: PWPGPL0299

Materiale: Plexiglass spessore 3 mm. Prodotto personalizzabile.

Made of: Perspex thickness 3 mm. Customizable product



PORTACONI ANGOLO VIVO
Sharp edged cone holder

▶ COD: PWPGPL0399

Materiale: Plexiglass spessore 5 mm. Prodotto personalizzabile.

Made of: Perspex thickness 5 mm. Customizable product.



PORTACONI SAGOMATO
Shaped cone holder

▶ COD: PWPGPL0499

Materiale: Plexiglass spessore 3 mm. Prodotto personalizzabile.

Made of: Perspex thickness 3 mm. Customizable product.



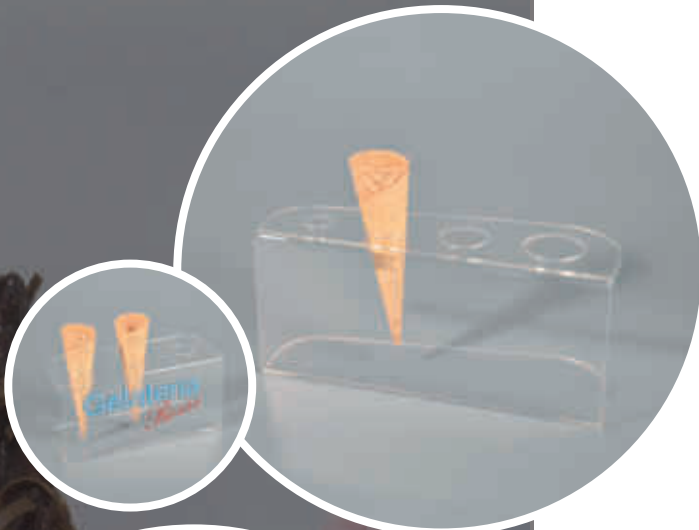

PORTACONI ANGOLO ARROTONDATO
Rounded edge cone holder

► **COD: PWPGPL0599**

Materiale: Plexiglass spessore 3 mm. Prodotto personalizzabile.

Made of: Perspex thickness 3 mm. Customizable product.



PORTA MACARON
Macaron holder

► **COD: PWPGPL0699**

Materiale: Plexiglass spessore 3 mm. Prodotto personalizzabile.

Made of: Perspex thickness 3 mm. Customizable product.



SEGNAGUSTI CLASSICI
Taste tags

► **COD: PWPGPL0799**

Materiale: Plexiglass spessore 3 mm. Prodotto personalizzabile.

Made of: Perspex thickness 3 mm. Customizable product.



SEGNAGUSTI SAGOMATI
Shaped taste tags

► **COD: PWPGPL0899**

Materiale: Plexiglass spessore 3 mm. Prodotto personalizzabile.

Made of: Perspex thickness 3 mm. Customizable product.



FINGER FOOD

Finger food

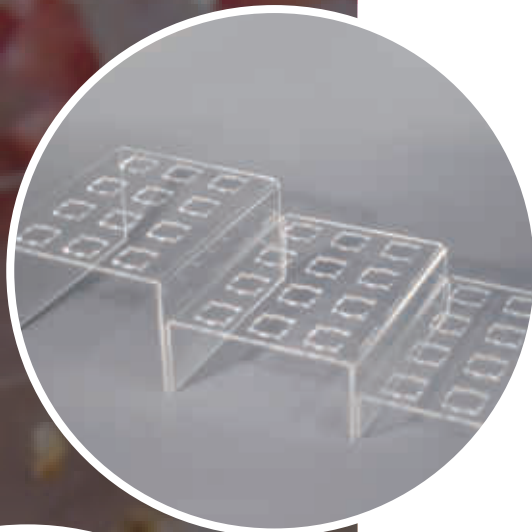

ALZATA PER FINGER FOOD
Finger food riser

▶ COD: PWFFPL0108

Materiale: Plexiglass spessore 5 mm. Prodotto personalizzabile.

Made of: Perspex thickness 5 mm. Customizable product.

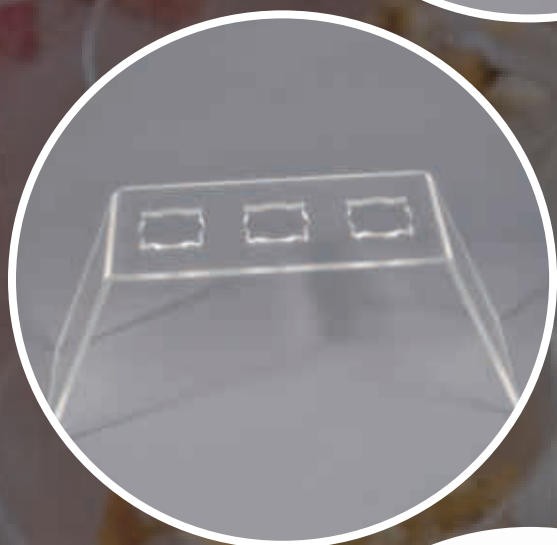

PORTA FINGER FOOD
Finger food holder

▶ COD: PWFFPL0208

Materiale: Plexiglass spessore 3 mm. Prodotto personalizzabile.

Made of: Perspex thickness 3 mm. Customizable product.



ALZATA PER FINGER FOOD
Finger food riser

▶ COD: PWFFPL0308

Materiale: Plexiglass spessore 3 mm. Prodotto personalizzabile.

Made of: Perspex thickness 3 mm. Customizable product.



PORTA FINGER FOOD
Finger food holder

▶ COD: PWFFPL0408

Materiale: Plexiglass spessore 3 mm. Prodotto personalizzabile.

Made of: Perspex thickness 3 mm. Customizable product.



ESPOSITORI *Displays*



PORTA MESSAGGI
Holder for promotional messages

► **COD: PWESPL0108**

Materiale: Plexiglass spessore 3 mm. Prodotto personalizzabile.

Made of: Perspex thickness 3 mm. Customizable product.



PORTA VOLANTINI
Leaflet holder

► **COD: PWESPL0208**

Materiale: Plexiglass spessore 3 mm. Prodotto personalizzabile.

Made of: Perspex thickness 3 mm. Customizable product.



PORTA VOLANTINI
Leaflet holder

► **COD: PWESPL0308**

Materiale: Plexiglass spessore 3 mm. Prodotto personalizzabile.

Made of: Perspex thickness 3 mm. Customizable product.

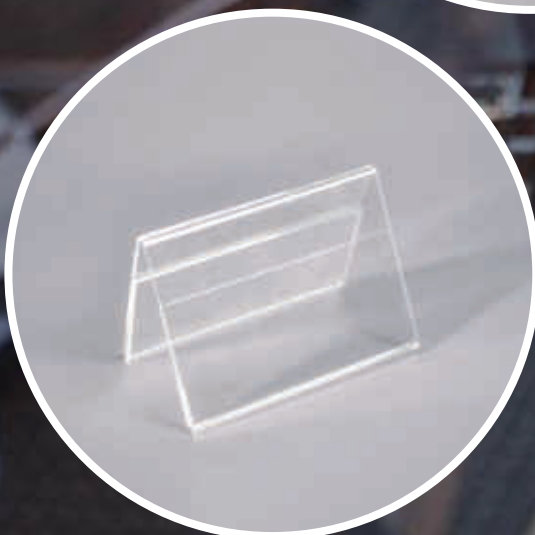

PORTA MESSAGGI
Holder for promotional messages

► **COD: PWESPL0408**

Materiale: Plexiglass spessore 3 mm. Prodotto personalizzabile.

Made of: Perspex thickness 3 mm. Customizable product.

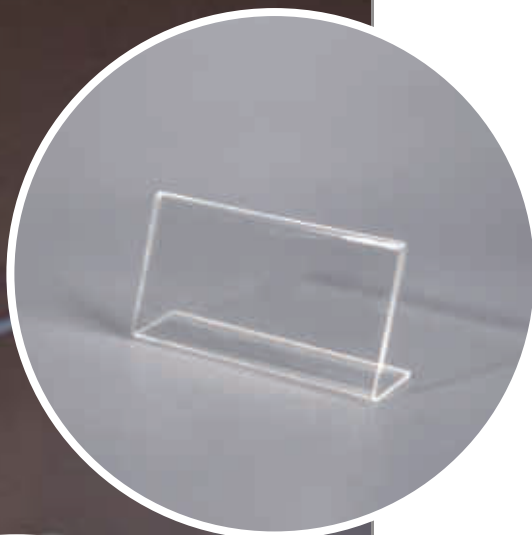

PORTA MESSAGGI
Holder for promotional messages

► **COD: PWESPL0508**

Materiale: Plexiglass spessore 3 mm. Prodotto personalizzabile.

Made of: Perspex thickness 3 mm. Customizable product.

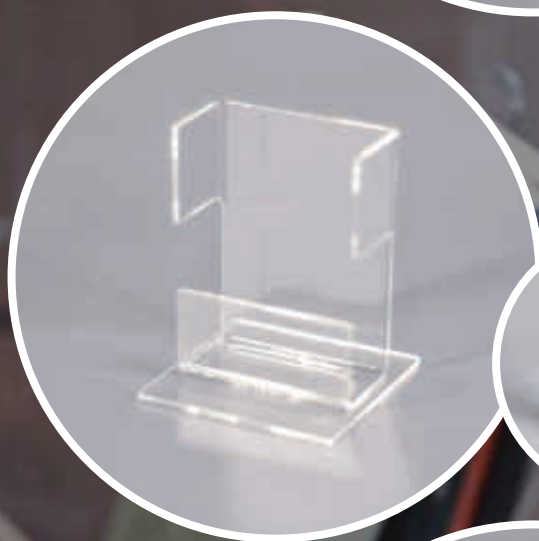

ESPOSITORE PER SMARTPHONE
Smartphone display

► **COD: PWESPL0608**

Materiale: Plexiglass spessore 3 mm. Prodotto personalizzabile.

Made of: Perspex thickness 3 mm. Customizable product.

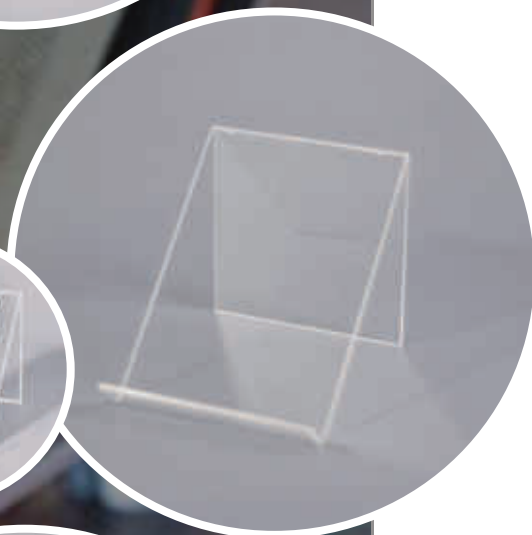

ESPOSITORE PER SMARTPHONE
Smartphone display

► **COD: PWESPL0708**

Materiale: Plexiglass spessore 3 mm. Prodotto personalizzabile.

Made of: Perspex thickness 3 mm. Customizable product.



ESPOSITORE PER SMARTPHONE
Smartphone display

► **COD: PWESPL1708**

Misure e spessori possono variare a seconda del prodotto e del tipo di utilizzo.

Size and thickness may vary depending on the product and its use.





ESPOSITORE PER SMARTPHONE
Smartphone display

► **COD: PWESPL1808**

Misure e spessori possono variare a seconda del prodotto e del tipo di utilizzo.

Size and thickness may vary depending on the product and its use.



ESPOSITORE COSMETICA
Cosmetic display stand

► **COD: PWESPL0808**

Materiale: Plexiglass spessore 3 mm. Prodotto personalizzabile.

Made of: Perspex thickness 3 mm. Customizable product.



ESPOSITORE
Display

► **COD: PWESPL0908**

Misure e spessori possono variare a seconda del prodotto e del tipo di utilizzo.

Size and thickness may vary depending on the product and its use.



ESPOSITORE
Display

► **COD: PWESPL1008**

Misure e spessori possono variare a seconda del prodotto e del tipo di utilizzo.

Size and thickness may vary depending on the product and its use.



ESPOSITORE PROFUMERIA
Perfumery display stand

► **COD: PWESPL1108**

Misure e spessori possono variare a seconda del prodotto e del tipo di utilizzo.

Size and thickness may vary depending on the product and its use.



ESPOSITORE
Display

► **COD: PWESPL1208**

Misure e spessori possono variare a seconda del prodotto e del tipo di utilizzo.

Size and thickness may vary depending on the product and its use.



ESPOSITORE
Display

► **COD: PWESPL1308**

Misure e spessori possono variare a seconda del prodotto e del tipo di utilizzo.

Size and thickness may vary depending on the product and its use.



ESPOSITORE
Display

► **COD: PWESPL1408**

Misure e spessori possono variare a seconda del prodotto e del tipo di utilizzo.

Size and thickness may vary depending on the product and its use.





PORTA BROCHURE
Brochure holder

► **COD: PWESPL1508**

Misure e spessori possono variare a seconda del prodotto e del tipo di utilizzo.

Size and thickness may vary depending on the product and its use.



ESPOSITORE BOTTIGLIE
Bottle display stand

► **COD: PWESPL1608**

Misure e spessori possono variare a seconda del prodotto e del tipo di utilizzo.

Size and thickness may vary depending on the product and its use.



CONTENITORE A CUPOLA
Domed container

► **COD: PWESPL1908**

Misure e spessori possono variare a seconda del prodotto e del tipo di utilizzo.

Size and thickness may vary depending on the product and its use.



CONTENITORE OVALE
Oval container

► **COD: PWESPL2008**

Misure e spessori possono variare a seconda del prodotto e del tipo di utilizzo.

Size and thickness may vary depending on the product and its use.



CONTENITORE
Container

► **COD: PWESPL2108**

Misure e spessori possono variare a seconda del prodotto e del tipo di utilizzo.

Size and thickness may vary depending on the product and its use.



CONTENITORE PORTA MESSAGGI
Ads holder container

► **COD: PWESPL2208**

Misure e spessori possono variare a seconda del prodotto e del tipo di utilizzo.

Size and thickness may vary depending on the product and its use.



CONTENITORE PORTA MESSAGGI
Ads holder container

► **COD: PWESPL2308**

Misure e spessori possono variare a seconda del prodotto e del tipo di utilizzo.

Size and thickness may vary depending on the product and its use.



CONTENITORE DA PAVIMENTO
Floor container

► **COD: PWESPL2408**

Misure e spessori possono variare a seconda del prodotto e del tipo di utilizzo.

Size and thickness may vary depending on the product and its use.



MODULI ESPOSITIVI

Display modules



ALZATA EFFETTO LEGNO
Wood effect riser

► COD: PWMEPL0134

Materiale: Plexiglass spessore 5 mm. Prodotto personalizzabile.

Made of: Perspex thickness 5 mm. Customizable product



VASSOIO
Tray

► COD: PWMEPL0208

Materiale: Plexiglass spessore 5 mm. Prodotto personalizzabile.

Made of: Perspex thickness 5 mm. Customizable product



ALZATA
Riser

► COD: PWMEPL0308

Materiale: Plexiglass spessore 5 mm. Prodotto personalizzabile.

Made of: Perspex thickness 5 mm. Customizable product



SUPPORTO PIATTI
Dish holder

► COD: PWMEPL0408

Materiale: Plexiglass spessore 3 mm. Prodotto personalizzabile.

Made of: Perspex thickness 3 mm. Customizable product

PORTA MESSAGGI E TARGHE

Ads and plate holder



PORTA MESSAGGI
Ads holder

► COD: PWCSPL0199

Misure e spessori possono variare a seconda del prodotto e del tipo di utilizzo.

Size and thickness may vary depending on the product and its use.



PORTA MESSAGGI
Ads holder

► COD: PWCSPL0299

Misure e spessori possono variare a seconda del prodotto e del tipo di utilizzo.

Size and thickness may vary depending on the product and its use.



PORTA MESSAGGI
Ads holder

► COD: PWCSPL0399

Misure e spessori possono variare a seconda del prodotto e del tipo di utilizzo.

Size and thickness may vary depending on the product and its use.



PORTA MESSAGGI
Ads holder

► COD: PWCSPL0499

Misure e spessori possono variare a seconda del prodotto e del tipo di utilizzo.

Size and thickness may vary depending on the product and its use.





TARGA
Plate

▶ COD: PWCSPLO599

Misure e spessori possono variare a seconda del prodotto e del tipo di utilizzo.

Size and thickness may vary depending on the product and its use.



TARGA
Plate

▶ COD: PWCSPLO699

Misure e spessori possono variare a seconda del prodotto e del tipo di utilizzo.

Size and thickness may vary depending on the product and its use.



TARGA
Plate

▶ COD: PWCSPLO799

Misure e spessori possono variare a seconda del prodotto e del tipo di utilizzo.

Size and thickness may vary depending on the product and its use.



TARGA
Plate

▶ COD: PWCSPLO899

Misure e spessori possono variare a seconda del prodotto e del tipo di utilizzo.

Size and thickness may vary depending on the product and its use.

CONTENITORI E MENSOLE

Containers and shelves



CONTENITORE
Container

► COD: PWBSPL0108

D : 22 x 15 H cm

Misure e spessori possono variare a seconda del prodotto e del tipo di utilizzo.

Size and thickness may vary depending on the product and its use.

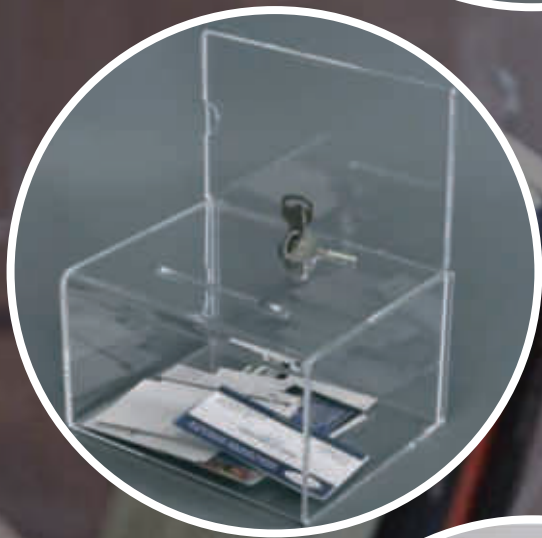

CONTENITORE CON CHIAVE
Container with key

► COD: PWBSPL0208

D : 22 x 15 H cm

Misure e spessori possono variare a seconda del prodotto e del tipo di utilizzo.

Size and thickness may vary depending on the product and its use.



MENSOLA
Shelf

► COD: PWBSPL0308

D : 22 x 15 H cm

Misure e spessori possono variare a seconda del prodotto e del tipo di utilizzo.

Size and thickness may vary depending on the product and its use.



SUPPORTO PER SCARPE
Shoes holder

► COD: PWBSPL0408

D : 22 x 15 H cm

Misure e spessori possono variare a seconda del prodotto e del tipo di utilizzo.

Size and thickness may vary depending on the product and its use.



PELLETTERIA E GIOIELLERIA

Leather goods and jewelry



SUPPORTO PER CINTURA
Belt holder

► **COD: PWBSPL0508**

D : 48 x 48 x 93 H cm

Misure e spessori possono variare a seconda del prodotto e del tipo di utilizzo.

Size and thickness may vary depending on the product and its use.



SUPPORTO PER PORTAFOGLI
Wallet holder

► **COD: PWBSPL0608**

D : 30 x 35 x 11,6 H cm

Misure e spessori possono variare a seconda del prodotto e del tipo di utilizzo.

Size and thickness may vary depending on the product and its use.



SUPPORTO PER OROLOGIO
Watch holder

► **COD: PWBSPL0708**

D : H 14 cm

Misure e spessori possono variare a seconda del prodotto e del tipo di utilizzo.

Size and thickness may vary depending on the product and its use.

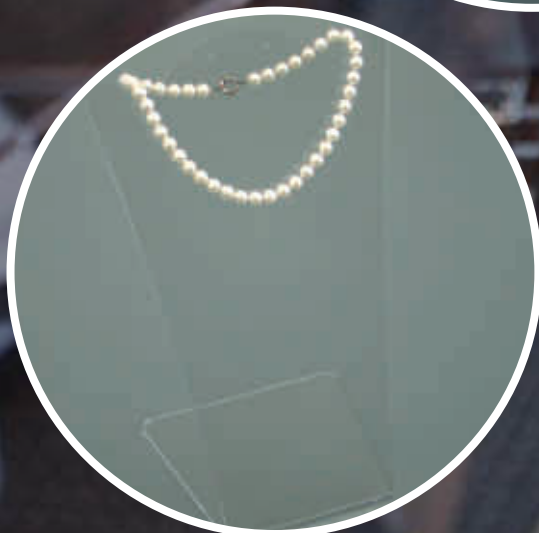

SUPPORTO PER GIOIELLI
Jewelry holder

► **COD: PWBSPL0808**

D : H 14 cm

Misure e spessori possono variare a seconda del prodotto e del tipo di utilizzo.

Size and thickness may vary depending on the product and its use.



Labellers
LABELS
& Rolls



Prezzatrici
ETICHETTE
e
Rotoli



ROTOLI

Rolls

Da sempre la nostra attenzione è rivolta a nuove applicazioni sia nel mondo retail che in altri settori, produciamo vari tipi di rotoli di carta termica specifici per ogni destinazione d'uso come i modelli di rotoli per registratori di cassa/POS... realizzati con la carta termica omologata, come stabilito da precise disposizioni normative, i nostri prodotti sono tutti realizzati con carta di elevata qualità.

Our focus has always been on new applications both in the retail world and in other sectors, one of these is thermal paper rolls, produced with high quality paper for cash registers and pos units. These rolls comply with current environmental regulations.



**GRAMMATURE DISPONIBILI
PER ROTOLI CASSA E POS :**
AVAILABLE PAPER TYPES FOR
CASH AND POS ROLLS:

48 gr per cm²

55 gr per cm²

70 gr per cm²

**GRAMMATURE DISPONIBILI
PER ROLOLO SCOMMESSE :**
AVAILABLE PAPER TYPE
FOR BET ROLL:

70 gr per cm²





ROTOLI CASSA

[RS:] rotoli per scatola
rolls per box

[SB:] scatole per bancale
boxes per pallet

[RB:] rotoli per bancale
rolls per pallet

Till rolls

		h(mm) l(m) Ø(mm)	RS	SB	RB
▶ COD: RTTM28301201	ROTOLO TERMICO OMOLOGATO REG. CASSA <i>Homologated till roll</i>	D : 28 x 30 x 12	100	50	5000
▶ COD: RTTM38301201	ROTOLO TERMICO OMOLOGATO REG. CASSA <i>Homologated till roll</i>	D : 38 x 30 x 12	50	100	5000
▶ COD: RTTM38351201	ROTOLO TERMICO OMOLOGATO REG. CASSA <i>Homologated till roll</i>	D : 38 x 35 x 12	50	80	4000
▶ COD: RTTM44351201	ROTOLO TERMICO OMOLOGATO REG. CASSA <i>Homologated till roll</i>	D : 44 x 35 x 12	50	120	6000
▶ COD: RTTM57251201	ROTOLO TERMICO OMOLOGATO REG. CASSA <i>Homologated till roll</i>	D : 57 x 25 x 12	50	100	5000
▶ COD: RTTM57271201	ROTOLO TERMICO OMOLOGATO REG. CASSA <i>Homologated till roll</i>	D : 57 x 27 x 12	50	100	5000
▶ COD: RTTM57301201	ROTOLO TERMICO OMOLOGATO REG. CASSA <i>Homologated till roll</i>	D : 57 x 30 x 12	50	100	5000
▶ COD: RTTM57321201	ROTOLO TERMICO OMOLOGATO REG. CASSA <i>Homologated till roll</i>	D : 57 x 32 x 12	50	100	5000
▶ COD: RTTM57351201	ROTOLO TERMICO OMOLOGATO REG. CASSA <i>Homologated till roll</i>	D : 57 x 35 x 12	50	100	5000
▶ COD: RTTM57601201	ROTOLO TERMICO OMOLOGATO REG. CASSA <i>Homologated till roll</i>	D : 57 x 60 x 12	30	96	2880
▶ COD: RTTM57751701	ROTOLO TERMICO OMOLOGATO REG. CASSA <i>Homologated till roll</i>	D : 57 x 75 x 17	30	42	1260
▶ COD: RTTM60601201	ROTOLO TERMICO OMOLOGATO REG. CASSA <i>Homologated till roll</i>	D : 60 x 60 x 12	50	56	2800
▶ COD: RTTM62351201	ROTOLO TERMICO OMOLOGATO REG. CASSA <i>Homologated till roll</i>	D : 62 x 35 x 12	50	70	3500
▶ COD: RTTM80701201	ROTOLO TERMICO OMOLOGATO REG. CASSA <i>Homologated till roll</i>	D : 80 x 70 x 12	50	48	2400
▶ COD: RTTM80721201	ROTOLO TERMICO OMOLOGATO REG. CASSA <i>Homologated till roll</i>	D : 80 x 72 x 12	50	48	2400
▶ COD: RTTM80751201	ROTOLO TERMICO OMOLOGATO REG. CASSA <i>Homologated till roll</i>	D : 80 x 75 x 12	50	48	2400
▶ COD: RTTM80761201	ROTOLO TERMICO OMOLOGATO REG. CASSA <i>Homologated till roll</i>	D : 80 x 76 x 12	50	48	2400
▶ COD: RTTM80801201	ROTOLO TERMICO OMOLOGATO REG. CASSA <i>Homologated till roll</i>	D : 80 x 80 x 12	50	48	2400



ROTOLI POS

Pos rolls

[RS:] rotoli per scatola
rolls per box

[SB:] scatole per bancale
boxes per pallet

[RB:] rotoli per bancale
rolls per pallet

		h(mm) l(mt)	RS	SB	RB
▶ COD: RTTP57121201	ROTOLO TERMICO POS <i>Thermal roll pos</i>	D : 57 x 12	50	100	5000
▶ COD: RTTP57151201	ROTOLO TERMICO POS <i>Thermal roll pos</i>	D : 57 x 15	50	100	5000
▶ COD: RTTP57161201	ROTOLO TERMICO POS <i>Thermal roll pos</i>	D : 57 x 16	50	100	5000
▶ COD: RTTP57181201	ROTOLO TERMICO POS <i>Thermal roll pos</i>	D : 57 x 18	50	132	6600
▶ COD: RTTP57201201	ROTOLO TERMICO POS <i>Thermal roll pos</i>	D : 57 x 20	50	132	6600





ROTOLI BILANCIA TERMICI NON ADESIVI

Non adhesive thermal scale rolls

[RS:] rotoli per scatola
rolls per box

[SB:] scatole per bancale
boxes per pallet

[RB:] rotoli per bancale
rolls per pallet

NVCSF		h(mm) l(m) Ø(mm)	RS	SB	RB
▶ COD: ETBT057135NP01	ROTOLO TERMICO ST. <i>Thermal roll ST.</i>	D : 57 x 135 x 25	20	60	1200
▶ COD: ETBT057030NP01	ROTOLO TERMICO ST. BILANCE <i>Thermal roll st. scales</i>	D : 57 x 30	50	100	5000
▶ COD: ETBT060030NP01	ROTOLO TERMICO ST. BILANCE <i>Thermal roll st. scales</i>	D : 60 x 30 x 12	50	100	5000
▶ COD: ETBT060090NP01	ROTOLO TERMICO ST. <i>Thermal roll ST.</i>	D : 60 x 25	30	40	1200
▶ COD: ETBT062150NP01	ROTOLO TERMICO ST. <i>Thermal roll ST.</i>	D : 62 x 15 x 12	20	60	1200
▶ COD: ETBT062030NP01	ROTOLO TERMICO ST. BILANCE <i>Thermal roll st. scales</i>	D : 62 x 30 x 12	50	100	5000
▶ COD: ETBT062090NP01	ROTOLO TERMICO ST. BILANCE <i>Thermal roll st. scales</i>	D : 62 x 90 x 25,4	30	50	1500
▶ COD: ETBT060150NP01	ROTOLO TERMICO ST. <i>Thermal roll ST.</i>	D : 60 x 15 x 12	20	60	1200

ROTOLI BILANCIA TERMICI ADESIVI

Adhesive thermal scale rolls

NVCSF		h(mm) l(m) Ø(mm)	RS	SB	RB
▶ COD: RTTA57362501	ROTOLO TERMICO ADESIVO <i>Adhesive thermal roll</i>	D : 57 x 36 x 25	50	50	2500
▶ COD: RTTA57402501	ROTOLO TERMICO ADESIVO <i>Adhesive thermal roll</i>	D : 57 x 40 x 25	50	50	2500
▶ COD: RTTA60362501	ROTOLO TERMICO ADESIVO <i>Adhesive thermal roll</i>	D : 60 x 36 x 25	50	50	2500
▶ COD: RTTA60402501	ROTOLO TERMICO ADESIVO <i>Adhesive thermal roll</i>	D : 60 x 40 x 25	30	100	3000
▶ COD: RTTA62382501	ROTOLO TERMICO ADESIVO <i>Adhesive thermal roll</i>	D : 62 x 38 x 25 cm	30	100	3000



ROTOLI LINERLESS SU CARTA TERMICA

LINERLESS

Rolls on thermal paper

I nostri rotoli Linerless non hanno più bisogno di un liner, infatti con un processo specifico, la superficie della carta termica viene rivestita con uno strato repellente. Questo prodotto ha vantaggi ecologici ed economici. Il Linerless protegge l'ambiente eliminando il liner e i costi per la gestione dei rifiuti sono ridotti veramente al minimo. I rotoli Linerless hanno un peso inferiore e hanno bisogno di meno spazio rispetto ai rotoli tradizionali. Di conseguenza, i costi di trasporto e di magazzino sono ridotti in modo significativo.

Inoltre è possibile personalizzarli, usarli nel campo alimentare e realizzarli in diverse misure

Our linerless rolls offer both economic and ecological advantages. No liner means:

- Less problems for the waste
- Reduced (-40 %) paper consumption
- Lower (in comparison to the standard ones) weight and consequently reduced warehouse and transport costs



CON ADESIVO PERMANENTE

With permanent adhesive

[RS]: rotoli per scatola
rolls per box

[SB]: scatole per bancale
boxes per pallet

[RB]: rotoli per bancale
rolls per pallet

		h(mm) l(m) Ø(mm)	RS	SB	RB
▶ COD: TLL565020P	ROTOLO IN CARTA TERMICA <i>Thermal paper roll</i>	D : 56,5 x 20 x 12,7	60	72	4320
▶ COD: TLL578065P	ROTOLO IN CARTA TERMICA <i>Thermal paper roll</i>	D : 57,8 x 65 x 4	50	100	5000
▶ COD: TLL600030P	ROTOLO IN CARTA TERMICA <i>Thermal paper roll</i>	D : 60 x 30 x 12	50	100	5000
▶ COD: TLL600090P	ROTOLO IN CARTA TERMICA <i>Thermal paper roll</i>	D : 60 x 25	30	40	1200
▶ COD: TLL620150P	ROTOLO IN CARTA TERMICA <i>Thermal paper roll</i>	D : 62 x 150 x 12,7	20	60	1200

CON ADESIVO REMOVIBILE

With removable adhesive

		h(mm) l(m) Ø(mm)	RS	SB	RB
▶ COD: TLL565020R	ROTOLO IN CARTA TERMICA <i>Thermal paper roll</i>	D : 56,5 x 20 x 12,7	60	72	4320
▶ COD: TLL578065R	ROTOLO IN CARTA TERMICA <i>Thermal paper roll</i>	D : 57,8 x 65 x 4	50	100	5000
▶ COD: TLL600030R	ROTOLO IN CARTA TERMICA <i>Thermal paper roll</i>	D : 60 x 30 x 12	50	100	5000
▶ COD: TLL600090R	ROTOLO IN CARTA TERMICA <i>Thermal paper roll</i>	D : 60 x 25	30	40	1200

CON DEEP FREEZE

With deepfreeze

		h(mm) l(m) Ø(mm)	RS	SB	RB
▶ COD: TLL563020F	ROTOLO IN CARTA TERMICA <i>Thermal paper roll</i>	D : 56,5 x 20 x 12,7	60	72	4320



ETICHETTE ADESIVE

Adhesive labels

Scoprite le nostre etichette ! Realizziamo soluzioni su misura per ogni tipologia di imballaggio e prodotto commerciale o industriale!

- Completamente personalizzabili
- Formati standard o su misura
- Progettazione grafica

Siamo in grado di offrire etichette stampate o neutre; per il settore oleario, vinicolo e conserviero o per inventariato. Prodotte con stampa classica, a trasferimento termico o in materiali speciali, adatte a particolari esigenze industriali e commerciali, stampate con tecnologia digitale per dati variabili. Siamo in grado di accompagnare il cliente nella creazione delle sue etichette per packaging industriale. Un servizio completo basato sulla professionalità e sulla capacità di essere un vero partner per ogni cliente

Please, take a look at our labels . We can produce and customize labels for many different applications : oil, wine, food, warehouse, offices. Supplies and much more. We can follow your requirements for dimensions and graphics . We can offer a complete support in order to create the label you need.

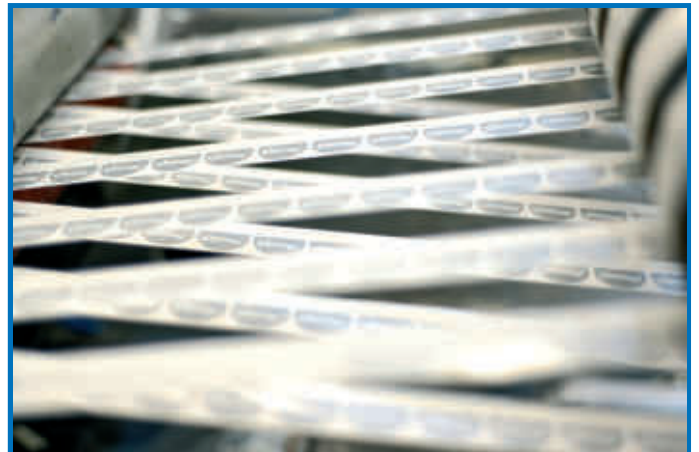



ETICHETTE ADESIVE PER BILANCIA

NEUTRE | CON GRIGLIA | PRESTAMPATE

Scale adhesive labels
BLANK | WITH GRILL | PREPRINTED

Rotoli di etichette adesive in carta termica per bilance self-service e da banco e per i confezionatori automatici. Prodotte con macchinari all'avanguardia, con l'utilizzo di materie di alta qualità, assicurano il funzionamento ottimale su ogni bilancia e garantiscono la possibilità di stampa fino a 8 colori. Per le industrie, la grande distribuzione, i retail, il settore sanitario, per quello dei trasporti e della logistica.

Rolls of adhesive labels made with thermal paper for scales and for automatic packers. Produced with high quality presses and, up to 8 colour prints materials, they allow the best operation on all scales. Designed for industries, large-scale distribution, retail, healthcare, transportation and logistics.



COMPATIBILI CON LE MIGLIORI MARCHE DI BILANCE

Compatible with the best brands of scales

[RS]: rotoli per scatola
rolls per box

[SB]: scatole per bancale
boxes per pallet

[RB]: rotoli per bancale
rolls per pallet

BIZERBA

**METTLER
TOLEDO**

		h(mm) l(mt)	RS	SB	RB
▶ COD: ETBT058043NP01	ROTOLO ETICHETTE TERMICO AN. 40 1.000 ET/RT <i>Thermal roll labels, 40 mm core, 1000 lab/roll</i>	D : 58 x 43	30	36	1080
▶ COD: ETBT058053NP01	ROTOLO ETICHETTE TERMICO AN. 40 750 ET/RT <i>Thermal roll labels, 40 mm core, 750 lab/roll</i>	D : 58 x 53	30	36	1080
▶ COD: ETBT058060NP01	ROTOLO ETICHETTE TERMICO AN. 40 750 ET/RT <i>Thermal roll labels, 40 mm core, 750 lab/roll</i>	D : 58 x 60	30	36	1080
▶ COD: ETBT058074NP01	ROTOLO ETICHETTE TERMICO AN. 40 620 ET/RT <i>Thermal roll labels, 40 mm core, 620 lab/roll</i>	D : 58 x 74	30	36	1080
▶ COD: EART58747601	ROTOLO ETICHETTE TERMICO AN. 76 2500 ET/RT <i>Thermal roll labels, 76 mm core, 2500 lab/roll</i>	D : 58 x 74	4	36	144

BERKEL

		h(mm) l(mt)	RS	SB	RB
▶ COD: ETBT040072NP01	ETICHETTE PER BILANCE CON FORO INTERNO 4 CM <i>Scale roll labels with 4 cm inner core</i>	D : 40 x 72	30	36	1080
▶ COD: ETBT047061NP01	ETICHETTE PER BILANCE CON FORO INTERNO 4 CM <i>Scale roll labels with 4 cm inner core</i>	D : 47 x 61	30	36	1080
▶ COD: ETBT047081NP01	ETICHETTE PER BILANCE CON FORO INTERNO 4 CM <i>Scale roll labels with 4 cm inner core</i>	D : 47 x 81	30	36	1080
▶ COD: ETBT061055NP01	ETICHETTE PER BILANCE CON FORO INTERNO 2,5 CM <i>Scale roll labels with 2,5 cm inner core</i>	D : 61 x 55	4	36	144

OMEGA bilance

		h(mm) l(mt)	RS	SB	RB
▶ COD: ETBT060045NP01	ETICHETTE PER BILANCE CON FORO INTERNO 2,5 CM <i>Scale roll labels with 2,5 cm inner core</i>	D : 60 x 45	30	36	1080
▶ COD: ETBT060075NP01	ETICHETTE PER BILANCE CON FORO INTERNO 4 CM <i>Scale roll labels with 2,5 cm inner core</i>	D : 60 x 75	30	36	1080



ETICHETTE PROMOZIONALI

Promotional labels

Le etichette promozionali sono ideali per rendere particolarmente visibile lo sconto o l'offerta dei prodotti in vendita. Assicurano massimo impatto visivo e sono perfette per evidenziare le informazioni al consumatore. Sono etichette fabbricate con tutti i tipi di materiale: carte, film plastici (PET, PP), in conformità con le normative vigenti (CE, IMQ, UL).

Promotional labels are perfect to highlight discounts or offers of products on sale. They ensure maximum visual impact and emphasise consumer information. These labels are made with all types of materials: papers and plastic films (PET, PP), in compliance with the current regulations (CE, IMQ, UL).



COD: PEPRRND001



D : Ø 4 cm

COD: PEPRRND002



D : Ø 4 cm

COD: PEPRRND003



D : Ø 4 cm

COD: PEPRRND004



D : Ø 4 cm

COD: PEPRRND005



D : Ø 4 cm

COD: PEPRRND006



D : Ø 3,6 cm

COD: PEPRRND007



D : Ø 3,6 cm

COD: PEPRRND008



D : Ø 3,6 cm

ROTLI DA 1000 PEZZI
E CARTONI DA 50 ROTOLI.

ROLLS OF 1000 PCS
AND CARTONS OF 50 ROLLS.

COD: PEPRRND009



D : Ø 4 cm

COD: PEPRRND010



D : Ø 4 cm

COD: PEPRRND011



D : Ø 4 cm

COD: PEPRRND012



D : Ø 4 cm

COD: PEPRRND013



D : Ø 5 cm

COD: PEPRRND014



D : Ø 4 cm

COD: PEPROVL001



D : 6 x 3,4 cm

COD: PEPROVL002



D : 6 x 3,4 cm

COD: PEPRSQR001



D : 4 x 4 cm

COD: PEPRSQR002



D : 4 x 4 cm

COD: PEPRSQR003



D : 4 x 4 cm

COD: PEPRSQR004



D : 4 x 4 cm

COD: PEPRSQR005



D : 4 x 4 cm

COD: PEPRRCT001



D : 5 x 3 cm

COD: PEPRRCT002



D : 5 x 2,5 cm

COD: PEPRRCT003



D : 5 x 3 cm

ROTOI DA 1000 PEZZI
E CARTONI DA 50 ROTOI.

ROLLS OF 1000 PCS
AND CARTONS OF 50 ROLLS.

COD: PEPRRCT004



D : 5 x 3 cm

COD: PEPRRCT005



D : 5 x 3 cm

COD: PEPRRCT006



D : 5 x 3 cm

COD: PEPRRCT007



D : 5 x 3 cm

COD: PEPRRCT008



D : 5 x 3 cm

COD: PEPRRCT009



D : 5 x 3 cm



ETICHETTE TERMICHE E A TRASFERIMENTO TERMICO NEUTRE E PRESTAMPATE

*Thermal and thermal transfer
labels, neutral and
preprinted*

La nostra produzione consiste principalmente nella realizzazione di etichette adesive in bobina su qualunque tipo di materiale cartaceo o film plastico (pvc, ppl, pp, pe) a seconda delle esigenze della nostra clientela. Abbiamo a disposizione oltre 700 fustelle (formati etichette) e siamo sempre in grado di realizzare forme e dimensioni di qualsiasi tipologia.

I nostri prodotti sono garantiti da materie prime di ottima qualità, inoltre il nostro personale qualificato e la vasta gamma di macchine produttive garantiscono tempi velocissimi di lavorazione. Contattateci per richiedere preventivo.

Our production includes adhesive labels on reels and on other materials or plastic films (such as pvc, ppl, pp, pe) according to our customers' requests. We have more than 700 available dies (label sizes) and can make any kind of shape and size.

We use the best quality of materials and our highly qualified staff and the wide range of our productive presses guarantee really fast processing time. Please contact us to request a quote.





CARTONCINI E FRONTALINI

Cardboard and fronts tags

Cartoncini prestampati o neutri con foro e pretaglio. Frontalini neutri o prestampati in rotolo e in Fan-Fold, per la comunicazione dei prezzi sui ripiani.

Preprinted and neutral cards with hole and precut. Blank or preprinted front tags in rolls and in Fan-Fold, to communicate prices on shelves. Plesase contact us to request a quote.



APPLICATORI PER ETICHETTE

Label applicators

APPLICATORE ELETTRONICO DI ETICHETTA DYNAMIC
Dynamic electronic applicator for labels.



► **COD: PRDELD7010**

Il suo sensore elettronico, identifica etichette con ogni tipo di forma (max 70 mm).

Its electronic sensor identifies any kind of label (max 70 mm).

ALIMENTATORE PER APPLICATORE ELETTRONICO
Electronic label applicator power-supply unit.



► **COD: PRDEAL7005**

Svolge la funzione di carica batteria.

It works as a battery charger

CARICA BATTERIA PER APPLICATORE ELETTRONICO.
Battery charger for electronic applicator.



► **COD: PRDEBC7005**

► **COD: PRDEBT7005**

Batteria supplementare.
Extra battery

APPLICATORE MANUALE MD60.
MD60 manual applicator.



► **COD: PRDMMMD6005**

Etichette: larghezza da 2 a 6 cm
Label width: from 2 to 6 cm





PREZZATRICI *Labellers*

Le Prezzatrici sono uno strumento fondamentale nella vita di un'attività commerciale. Tracciare i prodotti con le prezzatrici è un lavoro veloce ed economico.

Disponiamo di una completa gamma di sistemi di etichettatura e prezzatrici.

Ideali per l'apposizione di prezzi, sono disponibili in un'ampia gamma di modelli per rispondere alle vostre esigenze. Realizzate con materiali rinforzati, sono robuste, di lunga durata e di facile manutenzione.

Questi prodotti sono facili da utilizzare, hanno simboli standard, sono leggeri e maneggevoli. Le prezzatrici manuali professionali sono utilizzate per la stampa di codici, prezzi, date di scadenza e caratteristiche dei prodotti.



Our labellers are a fundamental tool in everyday's life activities. Tracing products with labellers is a quick and cheap job.

We have a complete range, the largest in the world, ready to meet all your needs.

Made with reinforced materials, they are robust, long-lasting and easy to maintain.

These products are easy to use, have standard symbols and are light and easy to handle. Our professional labellers are used for printing codes, prices, promotional texts, expiration dates and product characteristics.



PREZZATRICE ECONOMICA SERIE SWING
Swing series labeller



COD: PRSW06L112

Etichette: 26 x 12 mm
Una linea 6 caratteri
*Labels: 26 x 12 mm
6 characters on a single line.*

COD: PRSW08L112

Etichette: 26 x 12 mm
Una linea 8 caratteri
*Labels: 26 x 12 mm
8 characters on a single line*

COD: PRSW14L212

Etichette: 26 x 16 mm
2 linee 14 caratteri
•Linea superiore 8 caratteri
•Linea inferiore 6 caratteri
*Labels : 26 x 16 mm
14 characters; 2 lines.
•8 characters on upper line
•6 characters on lower line*

COD: PRSW16L212

Etichette: 26 x 16 mm
2 linee 16 caratteri
•Linea superiore 8 caratteri
•Linea inferiore 8 caratteri
*Labels : 26 x 16 mm
16 characters; 2 lines.
• 8 characters on upper line
• 8 characters on lower line*

COD: PRSW17L212

Etichette: 26 x 16 mm
2 linee 17 caratteri
•Linea superiore 10 caratteri
•Linea inferiore 7 caratteri
•Rullini inchiostriatori Jolly
*Labels : 26 x 16 mm
17 characters; 2 lines.
• 10 characters on upper line
• 7 characters on lower line
• Jolly series ink rollers*

PREZZATRICE PROFESSIONALE SERIE EVO SMALL
Evo Small series professional labeller



COD: PREV06L105

Etichette: 26 x 12 mm
Una linea 6 caratteri
*Labels : 26 x 12 mm
6 character on a single line*

COD: PREV10L105

Etichette: 26 x 12 mm
Una linea 10 caratteri
*Labels : 26 x 12 mm
10 characters on a single line.*

COD: PREV14L205

Etichette: 26 x 16 mm
2 linee 14 caratteri
•Linea superiore 8 caratteri
•Linea inferiore 6 caratteri
*Labels : 26 x 16 mm
14 characters; 2 lines
• 8 characters on upper line
• 6 characters on lower line*

PREZZATRICE PROFESSIONALE SERIE EVO PROMO UNA LINEA
Single line Evo Promo series professional labeller.



► **COD:PREVPRL110**

Etichette
Ovali:
 37 x 28 mm
 Rettangolari:
 37 x 28 mm
Labels
Oval:
 37 X 28 mm
Rectangular:
 37 X 28 mm

► **COD: PREVPTL110**

Etichette
Tonde:
 Ø 35 mm
Round
Labels:
 Ø 35 mm

PREZZATRICE PROFESSIONALE SERIE EVO BIG
Evo Large series professional labeller



► **COD: PREV27M210**

Etichette: 29 x 28 mm
 2 linee.
 Linea superiore 12 caratteri (Altezza 0,45 cm)
 Linea inferiore 7 caratteri (Altezza 0,85 cm)
Labels :29 x 28 mm
 2 lines.
 • 12 character upper line (Size: 0,45 cm)
 • 7 character lower line (Size: 0,85 cm)

► **COD: PREVA17310**

Etichette: 29 x 28 mm
 3 linee.
 • Linea superiore 11 caratteri alfanumerici (Altezza: 0,3 cm)
 • Linea centrale 11 caratteri numerici (Altezza: 0,45 cm)
 • Linea inferiore 7 caratteri numerici (Altezza: 0,45 cm)
Labels 29 x 28 mm 3 lines.
 • 11 numeric char. upper line (Size: 0,3 cm)
 • 11 numeric characters middle line (Size: 0,45 cm)
 • 7 numeric characters lower line (Size: 0,45 cm)

► **COD: PREVC77310**

Etichette: 29 x 28 mm
 3 linee
 • Linea superiore diciture promozionali (Altezza: 0,3 cm)
 • Linea centrale 7 caratteri numerici (Altezza: 0,45 cm)
 • Linea inferiore 7 caratteri numerici (Altezza: 0,45 cm)
Labels 29 x 28 mm 3 lines
 • Upper line with promotional messages (Size: 0,3 cm)
 • 7 numeric characters middle line (Size: 0,45 cm)
 • 7 numeric characters lower line (Size: 0,45 cm)

ESEMPIO PROMOZIONALE B001
Promotional band Example B001

OFFERTA SPECIALE	Saldi	SCONTO 10%	3x2
OFFERTA	Novità!	SCONTO 20%	
PREZZO SCONTATO	PREZZO FISSO	SCONTO 30%	
SOTTO COSTO	NUOVO ARRIVO	SCONTO 50%	

ESEMPIO PROMOZIONALE B016
Promotional band Example B016

PREZZO RIBASSATO	SCONTO 20%	SCONTO 50%	PREZZO SCONTATO
Novità!	SCONTO 25%	3x2	
SCONTO 10%	SCONTO 30%	OFFERTA SPECIALE	
SCONTO 15%	SCONTO 40%	OFFERTA	

PREZZATRICE PROFESSIONALE SERIE BLITZ MAXI
Blitz Maxi series professional labeller



► **COD: PRBZ06L105**

- Etichette:** 26 x 16 mm
 una linea 6 caratteri.
 • Altezza carattere: 8.0 mm
- Label:* 26 x 16 mm
 6 character single line.
 • Character size: 8.0 mm

PREZZATRICE PROFESSIONALE SERIE BLITZ 3 LINEE
Blitz 3 lines series professional labeller



28-FEB-2010

SCONTO 20%

€65.50

LOT 42006240
 DA CONSUMARSI
 30-06-2008--
PASTICCERIA ERZA
 222€-16.50

PRODOTTO 05/99

DA CONS. 05/02

€65.50

► **COD: PRBZP1L305**

- Etichette:** 37 x 28 mm
- Linea superiore 11 caratteri alfanumerici (Altezza: 0,3 cm)
 - Linea centrale dicitura promozionale (Altezza: 0,3 cm)
 - Linea inferiore 7 caratteri numerici (Altezza: 0,45 cm)

Labels : 37 x 28 mm

- 11 alphanumeric characters on upper line (Size: 0,3 cm)
- Middle line with "PROMO" bands (Size: 0,3 cm)
- 7 numeric characters on lower line (Size: 0,45 cm)

► **COD: PRBZP2L305**

- Etichette:** 37 x 28 mm
- Linea superiore 12 caratteri alfanumerici (Altezza: 0,3 cm)
 - Prestampa
 - Linea centrale 12 caratteri numerici (Altezza: 0,3 cm)
 - Prestampa
 - Linea inferiore 12 caratteri numerici (Doppia Altezza: 0,3/0,45 cm)

Labels : 37 x 28 mm

- 12 alphanumeric characters on upper line (Size: 0,3 cm)
- 12 numeric characters on middle line (Size: 0,3 cm)
- Prepress
- 12 numeric characters on lower line (Double Size: 0,3/0,45 cm)

► **COD: PRBZP3L305**

- Etichette:** 37 x 28 mm
- Linea superiore max 14 caratteri alfanumerici (Altezza: 0,3 cm)
 - Linea centrale "DA CONS." 5 caratteri numerici (Altezza: 0,45 cm)
 - Linea inferiore 7 caratteri numerici (Altezza: 0,45 cm)

Labels: 37 x 28 mm

- Upper line with max 14 numeric characters (Size: 0,3 cm)
- "DA CONS." 5 numeric character middle line (Size: 0,45 cm)
- 7 numeric characters on lower line (Size: 0,45 cm)



TAMPONI PER PREZZATRICI

Ink rollers for labellers

SKY		EVO		OPEN 3 linee	
▼ COD: PRIRSK0105	▼ COD: PRIREV0105	▼ COD: PRBZP1L3	▼ COD: PRIREV0505	▼ COD: PRIRPN3405	▼ COD: PRIRPN3205
Confezione: 100 pz Package: 100 pcs	Confezione: 100 pz Package: 100 pcs	Blister: 5 pz Blister: 5 pcs	Blister: 5 pz Blister: 5 pcs	Confezione: 40 pz Package: 40 pcs	Blister: 2 pz Blister: 2 pcs
OPEN		BLITZ		EVO 3 linee	
▼ COD: PRIROP0105	▼ COD: PRIROP0505	▼ COD: PRIRBL0105	▼ COD: PRIRBL0505	▼ COD: PRIREV3405	▼ COD: PRIREV3205
Confezione: 100 pz Package: 100 pcs	Blister: 5 pz Blister: 5 pcs	Confezione: 100 pz Package: 100 pcs	Blister: 5 pz Blister: 5 pcs	Confezione: 40 pz Package: 40 pcs	Blister: 2 pz Blister: 2 pcs
SWING		JOLLY		BLITZ 3 linee	
▼ COD: PRIRSW0105	▼ COD: PRIRSW0505	▼ COD: PRIRJL0105	▼ COD: PRIRJL0505	▼ COD: PRIRBL3405	▼ COD: PRIRBL3205
Confezione: 100 pz Package: 100 pcs	Blister: 5 pz Blister: 5 pcs	Confezione: 100 pz Package: 100 pcs	Blister: 5 pz Blister: 5 pcs	Confezione: 40 pz Package: 40 pcs	Blister: 2 pz Blister: 2 pcs
MOTEX		PRIX		METO 3 linee	
▼ COD: PRIRMX0105	▼ COD: PRIRMX0505	▼ COD: PRIRPX0105	▼ COD: PRIRPX0505	▼ COD: PRIRME3405	▼ COD: PRIRME3205
Confezione: 100 pz Package: 100 pcs	Blister: 5 pz Blister: 5 pcs	Confezione: 100 pz Package: 100 pcs	Blister: 5 pz Blister: 5 pcs	Confezione: 40 pz Package: 40 pcs	Blister: 2 pz Blister: 2 pcs
CONTACT		SMART			
▼ COD: PRIRCT0105	▼ COD: PRIRCT0505	▼ COD: PRIRSM0105	▼ COD: PRIRSM0505		
Confezione: 100 pz Package: 100 pcs	Blister: 5 pz Blister: 5 pcs	Confezione: 100 pz Package: 100 pcs	Blister: 5 pz Blister: 5 pcs		
TOVEL		METO			
▼ COD: PRIRTV0105	▼ COD: PRIRTV0505	▼ COD: PRIRME0105	▼ COD: PRIRME0505		
Confezione: 100 pz Package: 100 pcs	Blister: 5 pz Blister: 5 pcs	Confezione: 100 pz Package: 100 pcs	Blister: 5 pz Blister: 5 pcs		

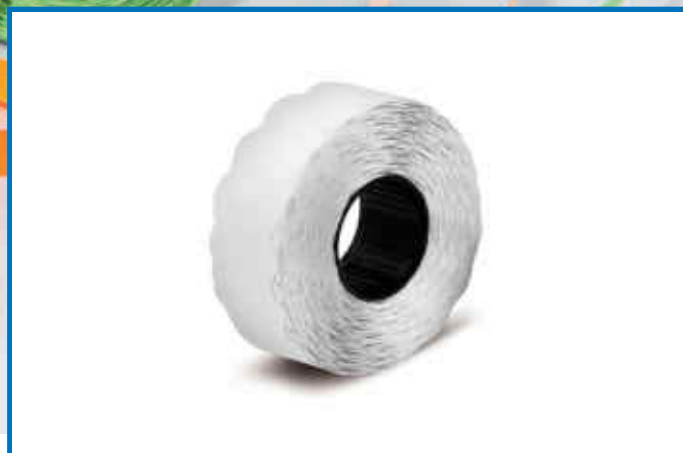

ETICHETTE PER PREZZATRICI

Labels for labellers

Le nostre etichette sono state studiate per le prezzatrici ad una, due o tre linee. Di misure differenti, sono disponibili in varie versioni: etichette removibili, non lasciano traccia se vengono staccate e etichette permanenti. Le etichette con i prezzi degli articoli al dettaglio devono essere chiare e leggibili, per non confondere i clienti e creare fin da subito un rapporto corretto e trasparente tra il produttore e il potenziale acquirente. Le etichette per prezzatrici comprendono numerosi modelli e possono essere neutre, in carta fluorescente con adesivo permanente, per surgelati, removibili, in diversi formati. Produciamo etichette di alta qualità personalizzandole in base a ogni Vostra specifica richiesta.



Our labels are designed for labellers printing 1, 2 and 3 lines. They can have several sizes and can be produced with different adhesives, removable that leaves no residue on products once the label is removed or permanent which has a much stronger grip on items. In addition we can produce labels suitable for freezer applications and / or with special characteristics. Labels in retail must show clear and readable prices in order to grant a correct and transparent link between the seller and the potential buyer. We can produce blank, coloured and customized labels based on your request.



ETICHETTA ADESIVA PER PREZZATRICE 21 X 12 MM PRESTAMPATA CON RIGHE ROSSE.
 21 X 12 mm adhesive label with 2 red lines

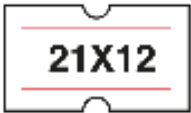

COD: ETPR2112TP01

Colla: Permanente
 Adhesive: Permanent

COD: ETPR2112TR01

Colla: Rimovibile
 Adhesive: Removable

COD: ETPR2112TS01

Colla: Surgelati
 Adhesive: Frozen Products

CONFEZIONE: 50 rotoli 1000 Etichette per Rotolo
 PACKAGE: 50 rolls 1000 labels per Roll

ETICHETTA ADESIVA PER PREZZATRICE 21 X 12 MM.
 21 X 12 mm adhesive label

COLORI/ COLOURS :



COD: ETPR2112CP

Colla: Permanente
 Adhesive: Permanent

COD: ETPR2112CR

Colla: Rimovibile
 Adhesive: Removable

COD: ETPR2112CS

Colla: Surgelati
 Adhesive: Frozen Products

COD: ETPR2112FP

Colla: Permanente
 Adhesive: Permanent

COD: ETPR2112FR

Colla: Rimovibile
 Adhesive: Removable

COD: ETPR2112FS

Colla: Surgelati
 Adhesive: Frozen Products

CONFEZIONE: 50 rotoli 1000 Etichette per Rotolo
 PACKAGE: 50 rolls 1000 labels per Roll

ETICHETTA ADESIVA PER PREZZATRICE 22 X 16 MM
 22 X 16 mm adhesive label

COLORI/ COLOURS :



COD: ETPR2216CP

Colla: Permanente
 Adhesive: Permanent

COD: ETPR2216CR

Colla: Rimovibile
 Adhesive: Removable

COD: ETPR2216CS

Colla: Surgelati
 Adhesive: Frozen Products

COD: ETPR2216FP

Colla: Permanente
 Adhesive: Permanent

COD: ETPR2216FR

Colla: Rimovibile
 Adhesive: Removable

COD: ETPR2216FS

Colla: Surgelati
 Adhesive: Frozen Products

CONFEZIONE: 42 rotoli 1000 Etichette per Rotolo
 PACKAGE: 42 rolls 1000 labels per roll

ETICHETTA ADESIVA PER PREZZATRICE 26 X 12 MM
 26 X 12 mm adhesive label

COLORI/ COLOURS :



COD: ETPR2612CP

Colla: Permanente
 Adhesive: Permanent

COD: ETPR2612CR

Colla: Rimovibile
 Adhesive: Removable

COD: ETPR2612CS

Colla: Surgelati
 Adhesive: Frozen Products

COD: ETPR2612FP

Colla: Permanente
 Adhesive: Permanent

COD: ETPR2612FR

Colla: Rimovibile
 Adhesive: Removable

COD: ETPR2612FS

Colla: Surgelati
 Adhesive: Frozen Products

CONFEZIONE: 36 rotoli 1500 Etichette per Rotolo
 PACKAGE: 36 rolls 1500 labels per roll

ETICHETTA ADESIVA PER PREZZATRICE 26 X 16 MM
 26 X 16 mm adhesive label

COLORI/ COLOURS :

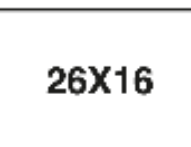

COD: ETPR2616CP

Colla: Permanente
 Adhesive: Permanent

COD: ETPR2616CR

Colla: Rimovibile
 Adhesive: Removable

COD: ETPR2616CS

Colla: Surgelati
 Adhesive: Frozen Products

COD: ETPR2616FP

Colla: Permanente
 Adhesive: Permanent

COD: ETPR2616FR

Colla: Rimovibile
 Adhesive: Removable

COD: ETPR2616FS

Colla: Surgelati
 Adhesive: Frozen Products

CONFEZIONE: 36 rotoli 1000 Etichette per Rotolo
 PACKAGE: 36 rolls 1000 labels per Roll

ETICHETTA ADESIVA PER PREZZATRICE 26 X 19 MM

26 X 19 mm adhesive label

COLORI/ COLOURS :

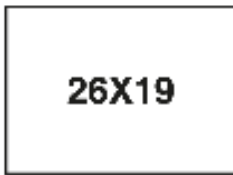

COD: ETPR2619CP

Colla: Permanente
Adhesive: Permanent

COD: ETPR2619CR

Colla: Rimovibile
Adhesive: Removable

COD: ETPR2619CS

Colla: Surgelati
Adhesive: Frozen Products

COD: ETPR2619FP

Colla: Permanente
Adhesive: Permanent

COD: ETPR2619FR

Colla: Rimovibile
Adhesive: Removable

COD: ETPR2619FS

Colla: Surgelati
Adhesive: Frozen Products

CONFEZIONE: 36 rotoli 1000 Etichette per Rotolo

PACKAGE: 36 rolls 1000 labels per Roll

ETICHETTA ADESIVA PER PREZZATRICE 26 X 19 MM

26 X 19 mm adhesive label



COD: ETPR2619HP

Colla: Permanente
Adhesive: Permanent

COD: ETPR2619HR

Colla: Rimovibile
Adhesive: Removable

COD: ETPR2619HS

Colla: Surgelati
Adhesive: Frozen Products

ETICHETTA ADESIVA PER PREZZATRICE 29 X 28 MM

29 X 28 mm adhesive label

COLORI/ COLOURS :

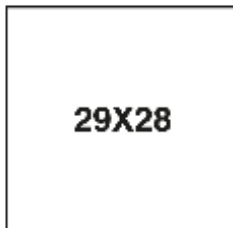

COD: ETPR2928CP

Colla: Permanente
Adhesive: Permanent

COD: ETPR2928CR

Colla: Rimovibile
Adhesive: Removable

COD: ETPR2928CS

Colla: Surgelati
Adhesive: Frozen Products

COD: ETPR2928FP

Colla: Permanente
Adhesive: Permanent

COD: ETPR2928FR

Colla: Rimovibile
Adhesive: Removable

COD: ETPR2928FS

Colla: Surgelati
Adhesive: Frozen Products

CONFEZIONE: 30 rotoli 700 Etichette per Rotolo

PACKAGE: 30 rolls 700 labels per roll

ETICHETTA ADESIVA PER PREZZATRICE 29 X 28 MM

29 X 28 mm adhesive label



COD: ETPR2928HP

Colla: Permanente
Adhesive: Permanent

COD: ETPR2928HR

Colla: Rimovibile
Adhesive: Removable

COD: ETPR2928HS

Colla: Surgelati
Adhesive: Frozen Products

ETICHETTA ADESIVA PER PREZZATRICE 32 X 19 MM

32 X 19 mm adhesive label

COLORI/ COLOURS :

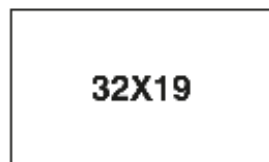

COD: ETPR3219CP

Colla: Permanente
Adhesive: Permanent

COD: ETPR3219CR

Colla: Rimovibile
Adhesive: Removable

COD: ETPR3219CS

Colla: Surgelati
Adhesive: Frozen Products

COD: ETPR3219FP

Colla: Permanente
Adhesive: Permanent

COD: ETPR3219FR

Colla: Rimovibile
Adhesive: Removable

COD: ETPR3219FS

Colla: Surgelati
Adhesive: Frozen Products

CONFEZIONE: 30 rotoli 1000 Etichette per Rotolo

PACKAGE: 30 rolls 1000 labels per Roll

ETICHETTA ADESIVA PER PREZZATRICE 37 X 19 MM
37 X 19 mm adhesive label

COLORI/ COLOURS :



COD: ETPR3719CP

Colla: Permanente
Adhesive: Permanent

COD: ETPR3719CR

Colla: Rimovibile
Adhesive: Removable

COD: ETPR3719CS

Colla: Surgelati
Adhesive: Frozen Products

COD: ETPR3719FP

Colla: Permanente
Adhesive: Permanent

COD: ETPR3719FR

Colla: Rimovibile
Adhesive: Removable

COD: ETPR3719FS

Colla: Surgelati
Adhesive: Frozen Products

CONFEZIONE: 24 rotoli 700 Etichette per Rotolo

PACKAGE: 24 rolls 700 labels per Roll

ETICHETTA ADESIVA PER PREZZATRICE 37 X 28 MM
37 X 28 mm adhesive label

COLORI/ COLOURS :

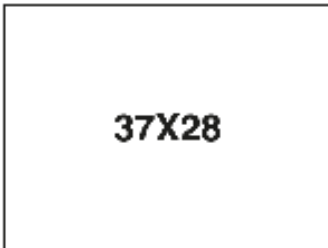

COD: ETPR3728CP

Colla: Permanente
Adhesive: Permanent

COD: ETPR3728CR

Colla: Rimovibile
Adhesive: Removable

COD: ETPR3728CS

Colla: Surgelati
Adhesive: Frozen Products

COD: ETPR3728FP

Colla: Permanente
Adhesive: Permanent

COD: ETPR3728FR

Colla: Rimovibile
Adhesive: Removable

COD: ETPR3728FS

Colla: Surgelati
Adhesive: Frozen Products

CONFEZIONE: 24 rotoli 400 Etichette per Rotolo

PACKAGE: 24 rolls 400 labels per roll

ETICHETTA ADESIVA PER PREZZATRICE FLASH
Flash adhesive label



COD: ETPR3728HP

Colla: Permanente
Adhesive: Permanent

COD: ETPR3728HR

Colla: Rimovibile
Adhesive: Removable

COD: ETPR3728HS

Colla: Surgelati
Adhesive: Frozen Products

ETICHETTE SAGOMATE
Wavy labels

ETICHETTA ADESIVA PER PREZZATRICE 22 X 12 MM
22x12 mm adhesive label

COLORI/ COLOURS :

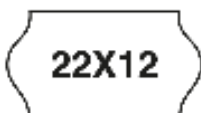

COD: ETPS2212CP

Colla: Permanente
Adhesive: Permanent

COD: ETPS2212CR

Colla: Rimovibile
Adhesive: Removable

COD: ETPS2212CS

Colla: Surgelati
Adhesive: Frozen Products

COD: ETPS2212FP

Colla: Permanente
Adhesive: Permanent

COD: ETPS2212FR

Colla: Rimovibile
Adhesive: Removable

COD: ETPS2212FS

Colla: Surgelati
Adhesive: Frozen Products

CONFEZIONE: 42 rotoli 1500 Etichette per Rotolo

PACKAGE: 42 rolls 1500 labels per Roll

ETICHETTA ADESIVA PER PREZZATRICE 22 X 16 MM

22x16mm adhesive label

COLORI/ COLOURS :



COD: ETPS2216CP

Colla: Permanente
Adhesive: Permanent

COD: ETPS2216CR

Colla: Rimovibile
Adhesive: Removable

COD: ETPS2216CS

Colla: Surgelati
Adhesive: Frozen Products

COD: ETPS2216FP

Colla: Permanente
Adhesive: Permanent

COD: ETPS2216FR

Colla: Rimovibile
Adhesive: Removable

COD: ETPS2216FS

Colla: Surgelati
Adhesive: Frozen Products

CONFEZIONE: 42 rotoli 1000 Etichette per Rotolo

PACKAGE: 42 rolls 1000 labels per Roll

ETICHETTA ADESIVA PER PREZZATRICE 26 X 12 MM

26x12 mm adhesive label

COLORI/ COLOURS :

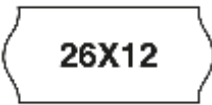

COD: ETPS2612CP

Colla: Permanente
Adhesive: Permanent

COD: ETPS2612CR

Colla: Rimovibile
Adhesive: Removable

COD: ETPS2612CS

Colla: Surgelati
Adhesive: Frozen Products

COD: ETPS2612FP

Colla: Permanente
Adhesive: Permanent

COD: ETPS2612FR

Colla: Rimovibile
Adhesive: Removable

COD: ETPS2612FS

Colla: Surgelati
Adhesive: Frozen Products

CONFEZIONE: 36 rotoli 1500 Etichette per Rotolo

PACKAGE: 36 rolls 1500 labels per roll

ETICHETTA ADESIVA PER PREZZATRICE 26 X 16 MM

26 X 16 mm adhesive labeller

COLORI/ COLOURS :

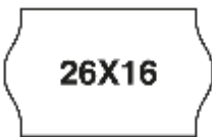

COD: ETPS2616CP

Colla: Permanente
Adhesive: Permanent

COD: ETPS2616CR

Colla: Rimovibile
Adhesive: Removable

COD: ETPS2616CS

Colla: Surgelati
Adhesive: Frozen Products

COD: ETPS2616FP

Colla: Permanente
Adhesive: Permanent

COD: ETPS2616FR

Colla: Rimovibile
Adhesive: Removable

COD: ETPS2616FS

Colla: Surgelati
Adhesive: Frozen Products

CONFEZIONE: 36 rotoli 1000 Etichette per Rotolo

PACKAGE: 36 rolls 1000 labels per roll

ETICHETTA ADESIVA PER PREZZATRICE 26 X 18 MM

26 X 18 mm adhesive label

COLORI/ COLOURS :

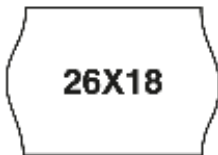

COD: ETPS2618CP

Colla: Permanente
Adhesive: Permanent

COD: ETPS2618CR

Colla: Rimovibile
Adhesive: Removable

COD: ETPS2618CS

Colla: Surgelati
Adhesive: Frozen Products

COD: ETPS2618FP

Colla: Permanente
Adhesive: Permanent

COD: ETPS2618FR

Colla: Rimovibile
Adhesive: Removable

COD: ETPS2618FS

Colla: Surgelati
Adhesive: Frozen Products

CONFEZIONE: 36 rotoli 1000 Etichette per Rotolo

PACKAGE: 36 rolls 1000 labels per Roll

ETICHETTA ADESIVA PER PREZZATRICE 32 X 19 MM

32 X 19 mm adhesive labeller

COLORI/ COLOURS :



COD: ETPS3219CP

Colla: Permanente
Adhesive: Permanent

COD: ETPS3219CR

Colla: Rimovibile
Adhesive: Removable

COD: ETPS3219CS

Colla: Surgelati
Adhesive: Frozen Products

COD: ETPS3219FP

Colla: Permanente
Adhesive: Permanent

COD: ETPS3219FR

Colla: Rimovibile
Adhesive: Removable

COD: ETPS3219FS

Colla: Surgelati
Adhesive: Frozen Products

CONFEZIONE: 30 rotoli 1000 Etichette per Rotolo

PACKAGE: 30 rolls 1000 labels per Roll

ETICHETTE CIRCOLARI

Round labels

ETICHETTA ADESIVA CIRCOLARE PER PREZZATRICE Ø 35 MM.
 Ø 35 mm round label

COLORI/ COLOURS :

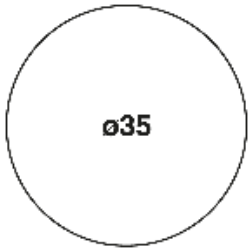

COD: ETPTD035CP

Colla: Permanente
 Adhesive: Permanent

COD: ETPTD035CR

Colla: Rimovibile
 Adhesive: Removable

COD: ETPTD035CS

Colla: Surgelati
 Adhesive: Frozen Products

COD: ETPTD035FP

Colla: Permanente
 Adhesive: Permanent

COD: ETPTD035FR

Colla: Rimovibile
 Adhesive: Removable

COD: ETPTD035FS

Colla: Surgelati
 Adhesive: Frozen Products

CONFEZIONE: 24 rotoli 400 Etichette per Rotolo
 PACKAGE: 24 rolls 400 labels per Roll

ETICHETTA ADESIVA PER PREZZATRICE FLASH
 Flash round adhesive label



COD: ETPTDH35HP

Colla: Permanente
 Adhesive: Permanent

COD: EPTPH035HR

Colla: Rimovibile
 Adhesive: Removable

COD: EPTPH035HS

Colla: Surgelati
 Adhesive: Frozen Products

ETICHETTA ADESIVA OVALE PER PREZZATRICE 37 X 28 MM
 37x28 mm oval adhesive label

COLORI/ COLOURS :



COD: ETPVOV37CP

Colla: Permanente
 Adhesive: Permanent

COD: ETPVOV37CR

Colla: Rimovibile
 Adhesive: Removable

COD: ETPVOV37CS

Colla: Surgelati
 Adhesive: Frozen Products

COD: ETPVOV37FP

Colla: Permanente
 Adhesive: Permanent

COD: ETPVOV37FR

Colla: Rimovibile
 Adhesive: Removable

COD: ETPVOV37FS

Colla: Surgelati
 Adhesive: Frozen Products

CONFEZIONE: 24 rotoli 500 Etichette per Rotolo
 PACKAGE: 24 rolls 500 labels per roll

ETICHETTA ADESIVA PER PREZZATRICE FLASH
 Flash adhesive label



COD: ETPVOV37HP

Colla: Permanente
 Adhesive: Permanent

COD: ETPVOV37HR

Colla: Rimovibile
 Adhesive: Removable

COD: ETPVOV37HS

Colla: Surgelati
 Adhesive: Frozen Products



TE200 SERIES

TE200 Series

► COD: PRPRTE200

TE200 SERIES - stampante desktop di codici a barre a trasferimento termico
 Superiore, veloce, alte prestazioni, caratterizzata dalla resistenza di tsc
Te200 series - desktop thermal transfer bar code printer
Superior, fast, high performance, featuring legendary tsc endurance

CARATTERISTICHE PRINCIPALI

KEY FEATURES

Risoluzione: 203 dpi (8 dots/mm)
Resolution 8 dots/mm (203 DPI)

Dimensioni stampante: 204 mm (L) x 164 mm (A) x 280 mm (P)
204 mm (W) x 164 mm (H) x 280 mm (L)

Metodo di stampa: Trasferimento termico e termico diretto
Printing method Thermal Transfer & Direct Thermal

Processore: 32-bit RISC da 400 MHz
Processor: 32-bit RISC 400 MHz

Memoria: 8 MB di memoria FLASH; 16 MB di SDRAM
Memory 8 MB Flash memory: 16 MB SDRAM

Velocità massima di stampa: 152.4 mm (6")/second
Max. print speed 152.4 mm (6")/second

Larghezza max stampa: 108 mm (4.25")
Max. print width 108 mm (4.25")

Lunghezza max. stampa: 2,794 mm (110")
Max. print length 2,794 mm (110")

Linguaggio: TSPL-EZ™ (Compatibile con EPL, ZPL, ZPL II)
Printer Language: TSPL-EZ™ (Compatible to EPL, ZPL, ZPL II, DPL)

Capacità rotolo: 127 mm
Label roll capacity: 127 mm (5") OD

Interfaccia: USB 2.0
Interface: Usb 2.0

APPLICAZIONI

APPLICATIONS

Produzione & Logistica *Production & Logistics*

- Spedizione e Entrata merci - Etichette di conformità
Work in Progress
- Marcatura prodotto
Item Labels
- Controllo Stock
Instruction Labels
- Gestione Documenti - Etichettatura Scaffali
Agency Labels

Sanità *Healthcare*

- Identità Pazienti
Patient Identification
- Farmacie
Pharmacy
- Etichette per Campioni
Specimen Identification

Servizi Postali *Parcel Post*

- Spedizione e ricevimento merci
Shipping and receiving Labels

Punti Vendita *Retail Marking*

- Riprezzamento
Repricing



G5 SERIES G5 Series

Potenza high-tech con un prezzo accessibile al cliente. La tecnologia "twin sensor" rende la G500 perfetta per la stampa su tutti i tipi di materiali speciali, in particolare per applicazioni commerciali e industriali

High-tech power with a customer friendly price. "Twin-sensor technology" makes G500 perfect for printing on all kinds of special materials especially for retail and industrial application



Il supporto esterno per etichette opzionale offre il massimo volume di stampa.
The optional external label holder offers maximum print volume.



Tecnologia Twin sensor
Twin sensor technology



USB 2.0 RS232 e Ethernet
USB 2.0 RS232 and Ethernet



Design robusto e stabile per affidabilità a lungo termine
Strong design and long term reliable mechanism

▶ COD: PRPRTG500S

CARATTERISTICHE PRINCIPALI G500 G500 KEY FEATURES

Risoluzione: 203 dpi (8 dots/mm)
Resolution 8 dots/mm (203 DPI)

Dimensioni stampante: 285 mm (L) x 171 mm (A) x 226 mm (P)
Printer dimensions: 285 mm (W) x 171 mm (H) x 226 mm (D)

Metodo: Trasferimento termico e termico diretto
Printing method Thermal Transfer & Direct Thermal

Processore: 32-bit RISC CPU
Processor 32-bit RISC CPU

Memoria: 8 MB di memoria FLASH; 16 MB di SDRAM
Memory 8 MB Flash memory: 16 MB SDRAM

Velocità: massima di stampa 127 mm/s (5 IPS)
Max. print speed 127 mm/s (5 IPS)
Lunghezza max stampa: 1727 mm (68")
Max. print length 1727 mm (68")

Larghezza max stampa: 108 mm (4.25")
Max. print width 108 mm (4.25")

Linguaggio: EZPL, GEPL, GZPL auto switch
Printer Language: EZPL, GEPL, GZPL auto switch

Interfaccia: USB 2.0, RS-232 (DB-9), Ethernet port RJ-45
Interfaces: USB 2.0, RS-232 (DB-9), Ethernet port RJ-45

Software: GoLabel Design Software
Software: GoLabel Design Software

▶ COD: PRPRTG530S

CARATTERISTICHE PRINCIPALI G530 G530 KEY FEATURES

Risoluzione: 300 dpi (12 dots/mm)
Resolution 12 dots/mm (300 DPI)

Dimensioni stampante: 285 mm (L) x 171 mm (A) x 226 mm (D)
Printer dimensions: 285 mm (W) x 171 mm (H) x 226 mm (D)

Metodo: Trasferimento termico e termico diretto
Printing method Thermal Transfer & Direct Thermal

Processore: 32-bit RISC CPU
Processor 32-bit RISC CPU

Memoria: 8 MB di memoria FLASH; 16 MB di SDRAM
Memory 8 MB Flash memory: 16 MB SDRAM

Velocità: massima di stampa 102 mm/s (4 IPS)
Max. print speed 102 mm/s (4 IPS)

Larghezza max stampa: 105.7 mm (4.16")
Max. print width 105.7 mm (4.16")

Lunghezza max stampa: 762 mm (30")
Max. print length 762 mm (30")

Linguaggio: EZPL, GEPL, GZPL auto switch
Printer Language: EZPL, GEPL, GZPL auto switch

Interfaccia: USB 2.0, RS-232 (DB-9), Ethernet port RJ-45
Interfaces: USB 2.0, RS-232 (DB-9), Ethernet port RJ-45

Software: GoLabel Design Software
Software: GoLabel Design Software

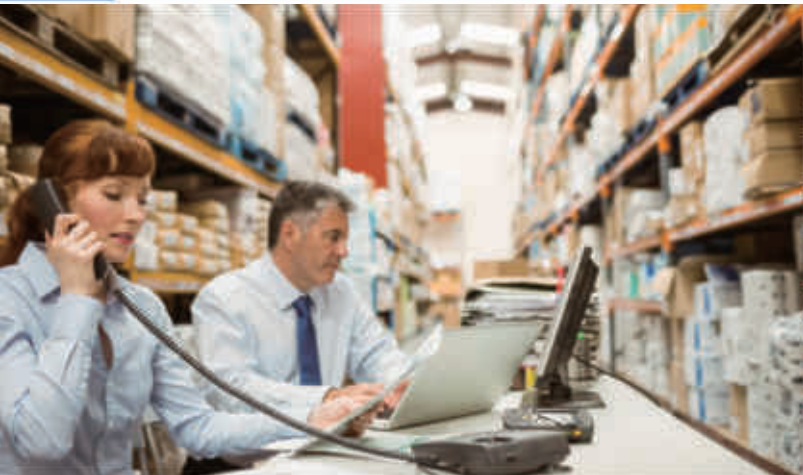

EZ SERIES EZ Series

Stampante di codici a barre industriale di fascia media adatta per la maggior parte delle applicazioni
Il design interamente in metallo con piano centrale e la base pressofusa rendono la serie EZ2250 perfetta per applicazioni ad alto volume.
*Enhanced mid-range industrial barcode printer for most applications
The all-metal design with central top and die-cast base make the EZ2250 series perfect for high volume applications.*



LCD TFT a colori e pannello operativo per un funzionamento facile e intuitivo.
Colour TFT LCD and operation panel for easy and intuitive operation.



Host USB per espansione di memoria e funzionamento stand-alone
USB host for memory expansion and stand-alone operation



Telaio industriale e meccanismo di stampa, tutti in metallo
Metal industrial frame and printing mechanism



Supporta ribbon con inchiostrazione interna / esterna
Supports ribbon with internal / external inking

► COD: PRPRTEZ2250S

CARATTERISTICHE PRINCIPALI EZ2250i EZ2250i KEY FEATURES

Risoluzione: 203 dpi (8 dots/mm)
Resolution 8 dots/mm (203 DPI)

Dimensioni stampante: 512 mm (L) x 291 mm (A) x 274 mm (P)
512 mm (L) x 291 mm (H) x 274 mm (W)

Metodo: Trasferimento termico e termico diretto
Printing method Thermal Transfer & Direct Thermal

Processore: 32-bit RISC CPU
Processor 32-bit RISC CPU

Memoria: 8 MB di memoria FLASH; 16 MB di SDRAM
Memory 8 MB Flash memory: 16 MB SDRAM

Velocità massima di stampa: 177 mm/s (7 IPS)
Max. print speed 177 mm/s (7 IPS)

Larghezza max stampa: 104 mm (4.09")
Max. print width 104 mm (4.09")

Lunghezza max stampa: 2540 mm (100")
Max. print length 2540 mm (100")

Linguaggio: EZPL, GEPL, GZPL; auto switch
Printer Language: EZPL, GEPL, GZPL: auto switch

Software: GoLabel Design Software
Software: GoLabel Design Software

► COD: PRPRTEZ2350S

CARATTERISTICHE PRINCIPALI EZ2350i EZ2350i KEY FEATURES

Risoluzione: 300 dpi (12 dots/mm)
Resolution 300 dpi (12 dots/mm)

Dimensioni stampante: 512 mm (L) x 291 mm (A) x 274 mm (P)
512 mm (L) x 291 mm (H) x 274 mm (W)

Metodo: Trasferimento termico e termico diretto
Printing method Thermal Transfer & Direct Thermal

Processore: 32-bit RISC CPU
Processor 32-bit RISC CPU

Memoria: 8 MB di memoria; 16 MB di SDRAM
Memory 8 MB Flash memory: 16 MB SDRAM

Velocità massima di stampa: 127 mm/s (5 IPS)
Max. print speed: 127 mm/s (5 IPS)

Larghezza max stampa: 104 mm (4.09")
Max. print width 104 mm (4.09")

Lunghezza max stampa: 1143 mm (45")
Max. print length 1143 mm (45")

Linguaggio: EZPL, GEPL, GZPL; auto switch
Printer Language: EZPL, GEPL, GZPL: auto switch

Software: GoLabel Design Software
Software: GoLabel Design Software



ZX SERIES

ZX series

Godex serie ZX rappresenta la nuova frontiera per le stampanti termiche. La serie ZX è caratterizzata da alcune specifiche estremamente importanti, come la robusta struttura metallica e la notevole risoluzione di stampa.

Godex ZX series represents the new frontier for thermal printers. The ZX series is characterized by some extremely important specifications, such as the strong metal structure and the remarkable print resolution.



Ampio touch screen LCD a colori intuitivo che consente all'utente di avere il controllo.
Large intuitive LCD colours touch screen allows the user to be in control



Tre porte host USB standard consentono l'integrazione con diversi dispositivi.
Three standard USB host ports allows integration with several devices



Stampante ad alte prestazioni progettata per applicazioni ad alto volume.
High performance printer designed for high volume applications

▶ COD: PRPRTZX1200S

CARATTERISTICHE PRINCIPALI ZX1200i

ZX1200i KEY FEATURES

Risoluzione: 203 dpi (8 dots/mm)
Resolution: 203 dpi (8 dots/mm)

Dimensioni stampante: 465 mm (L) x 308,20 mm (A) x 270,21 mm (P)
Printer dimensions: 465 mm (L) x 308,20 mm (A) x 270,21 mm (P)

Metodo: Trasferimento termico e termico diretto
Printing method: Thermal Transfer & Direct Thermal

Processore: 32-bit RISC CPU
Processor 32-bit RISC CPU

Memoria: 128 MB di memoria FLASH; 32 MB di SDRAM
Memory 128 MB Flash memory: 32 MB SDRAM

Velocità: massima di stampa 254 mm/s (10 IPS)
Max. print speed 254 mm/s (10 IPS)

Larghezza max stampa: da 104 mm (4.09") a 108 mm (4.25")
Max. print width: 104 mm (4.09") up to 108 mm (4.25")

Lunghezza max stampa: 4572 mm (180")
Max. print length 4572 mm (180")

Linguaggio: EZPL, GEPL, GZPL; auto switch
Printer Language: EZPL, GEPL, GZPL: auto switch

Software: GoLabel Design Software
Software: GoLabel Design Software

▶ COD: PRPRTZX1300S

CARATTERISTICHE PRINCIPALI ZX1300i

ZX1300i KEY FEATURES

Risoluzione: 300 dpi (12 dots/mm)
Resolution: 300 dpi (12 dots/mm)

Dimensioni stampante: 465 mm (L) x 308 mm (A) x 270,21 mm (P)
Printer dimensions: 465 mm (L) x 308,8 mm (H) x 270,21 mm (W)

Metodo stampa: Trasferimento termico e termico diretto
Printing method Thermal Transfer & Direct Thermal

Processore: 32-bit RISC CPU
Processor 32-bit RISC CPU

Memoria: 128 MB di memoria FLASH; 32 MB di SDRAM
Memory 128 MB Flash memory: 32 MB SDRAM

Velocità: massima di stampa 177 mm/s (7 IPS)
Max. print speed 177 mm/s (7IPS)

Larghezza max stampa: da 104 mm (4.09") a 105,7 mm
Max. print width: 104 mm (4.09") up to 105,7 mm

Lunghezza max stampa: 2159 mm (85")
Max. print length 2159 mm (85")

Linguaggio: EZPL, GEPL, GZPL; auto switch
Printer Language: EZPL, GEPL, GZPL: auto switch

Software: GoLabel Design Software
Software: GoLabel Design Software



GODEX TXX GODEX TXX

Il riavvolgitore che può essere usato da tutti.
 Il riavvolgitore T10 / T20 ha un braccio tenditore che può essere posizionato per riavvolgere le etichette da entrambi i lati della stampante. A seconda delle esigenze dell'utente, il riavvolgitore può riavvolgere i rulli di etichette "internamente o esternamente".

A rewriter anyone can use The T10/ T20 rewriter has an idler arm that can be used to rewind labels from either side of the printer. Depending on the user's requirements, the rewriter can rewind "inside or outside" label rolls



L'indicatore LED a colori fornisce lo stato delle operazioni di riavvolgimento
Colour LED indicator provides rewriter operations status

► COD: PRGODEXT10

CARATTERISTICHE PRINCIPALI T10 T10 KEY FEATURES

Larghezza carta: 120 mm (4,72")
Paper width: 120 mm (4,72")

Velocità di riavvolgimento: Modalità automatica fino a 305 mm/s (14 IPS)
Rewind speed: Automatic mode up to 305 mm/s (14 IPS)

Rotolo di etichette: 203,2 mm (8")
Label roll: 203,2 mm (8")

Peso: 5 Kg
Weight: 5 Kg

Motore: motore ibrido
Motor: Hybrid motor

► COD: PRGODEXT20

CARATTERISTICHE PRINCIPALI T20 T20 KEY FEATURES

Larghezza carta: 177,8 mm (7")
Paper width: 177,8 mm (7")

Velocità di riavvolgimento: Modalità automatica fino a 305 mm/s (14 IPS)
Rewind speed: Automatic mode up to 305 mm/s (14 IPS)

Rotolo di etichette: 152,4 mm (6")
Label roll: 152,4 mm (6")

Peso: 5 Kg
Weight: 5 Kg

Motore: motore ibrido
Motor: Hybrid motor



RIBBON

Ribbon

Offriamo un'ampia gamma di ribbon specifici realizzati con materiali idonei ai più svariati utilizzi. La scelta del materiale di consumo più idoneo all'uso è fondamentale per ottenere sempre il massimo del risultato. Abbiamo tre tipologie di ribbon:

-Cera. I ribbon a base cera sono adatti per applicazioni standard, dove è richiesta una buona qualità visiva. Questi ribbon vengono utilizzati per i sovraccolli, per le spedizioni o per la stampa di etichette identificative dei prodotti a magazzino.

-Cera / Resina. I ribbon di composizione mista cera e resina si utilizzano per ottenere stampe di alta qualità resistenti anche al graffio, all'alcool e alle intemperie.

-Resina. I ribbon base resina sono utilizzati per stampa di etichette in materiali plastici, come PVC o poliestere, sui quali la stampa deve durare nel tempo e resistere ad agenti atmosferici o corrosivi.

We offer a wide range of specific ribbons made of materials suitable for a wide range of uses. The choice of the most suitable consumable is fundamental to achieve the best results. We have three types of ribbon:

-Wax. *The wax-based ribbons are suitable for standard applications, where good visual quality is required. These ribbons are used for over-caps, for shipments or for printing identification labels of products in stock.*

- Wax / Resin. *Ribbons of mixed wax and resin composition are used for high quality prints resistant to scratches, alcohol and bad weather conditions.*

-Resin. *The resin base ribbons are used to print labels in plastic materials, such as PVC or polyester, which need the print to last over time resisting to atmospheric or corrosive agents.*



GOLABEL SOFTWARE

GoLabel software

Il software di codici a barre con funzioni più avanzate. GoLabel è un software per la creazione di etichette gratuito e potente. Non solo rende la progettazione delle etichette semplice, intuitiva e facile, ma soddisfa anche una vasta gamma di esigenze di stampa. GoLabel è GRATUITO per tutti gli utenti di stampanti di codici a barre GoDEX.

Supporta la connessione con database e stampa SQL, ACCESS, ORACLE, EXCEL, TEXT, BDF

Supporta la maggior parte dei codici a barre 1D e 2D standard

Supporta la stampa in rete

Interfaccia utente multilingue (21 lingue)

Semplice da impostare per il funzionamento stand alone

Compatibile con tutta la gamma delle stampanti

GoDEX.

Barcode software with the best features. GoLabel is a free and powerful label creation software. Not only it makes label design simple, intuitive and easy, but it also responds to a wide range of printing needs. GoLabel is FREE for all users of GoDEX barcode printers.

It supports connection with database and prints SQL, ACCESS, ORACLE, EXCEL, TEXT, BDF

It supports most 1D and 2D barcodes standard. It supports network printing.

Multilingual user interface (21 languages) Simple to set up for stand alone operation.

Compatible with the entire range of GoDEX printers.



ANTI-THEFT
Consumables



Consumabili
ANTITACCHEGGIO

ACUSTICO MAGNETICO

Alarmed magnetic system

UNITÀ DISATTIVATORE CON PIATTO ACUSTOMAGNETICO
Deactivator unit with acoustomagnetic base



▶ COD: DVA2050

DISTACCATORE MECCANICO ACUSTOMAGNETICO
Acoustomagnetic mechanic detacher



▶ COD: DTAMAN00

DISTACCATORE SUPER CONICO
Super cone-shaped detacher



▶ COD: DTUCON00

DISTACCATORE SUPER ELEGANCE
Super Elegance detacher



▶ COD: DTUELE00

PROTEZIONI ADESIVE PER SISTEMA ACUSTICO MAGNETICO

Adhesive tags for acoustic magnetic system

PROTEZIONE ADESIVA 1,1 X 4,4 CM KE
1,1 X 4,4 cm KE adhesive tag



FALSO BARCODE
Fake barcode

▶ COD: SLAKE000

Confezione: 20.000 pezzi
Package: 20.000 pcs

▶ COD: SLAKE000BL

Blister: 5.000 pezzi
Blister: 5.000 pcs

BIANCA NEUTRA
White neutral

▶ COD: SLAKE001

Confezione: 20.000 pezzi
Package: 20.000 pcs

NERA NEUTRA
Black neutral

▶ COD: SLAKE002

Confezione: 20.000 pezzi
Package: 20.000 pcs

PROTEZIONE ADESIVA 1,1 X 4,4 CM KG
1,1 X 4,4 cm KG adhesive tag



FALSO BARCODE
Fake barcode

▶ COD: SLAKG000

Confezione: 20.000 pezzi
Package: 20.000 pcs

▶ COD: SLAKG000BL

Blister: 5.000 pezzi
Blister: 5.000 pcs

BIANCA NEUTRA
White neutral

▶ COD: SLAKG001

Confezione: 20.000 pezzi
Package: 20.000 pcs

▶ COD: SLAKG001BL

Blister: 5.000 pezzi
Blister: 5.000 pcs

NERA NEUTRA
Black neutral

▶ COD: SLAKG002

Confezione: 20.000 pezzi
Package: 20.000 pcs

▶ COD: SLAKG002BL

Blister: 5.000 pezzi
Blister: 5.000 pcs

PROTEZIONE ADESIVA 1,1 X 4,4 CM KM
1,1 X 4,4 cm KM adhesive tag



FALSO BARCODE
Fake barcode

▶ COD: SLAKM000

Confezione: 20.000 pezzi
Package: 20.000 pcs

▶ COD: SLAKM000BL

Blister: 5.000 pezzi
Blister: 5.000 pcs

BIANCA NEUTRA
White neutral

▶ COD: SLAKM001

Confezione: 20.000 pezzi
Package: 20.000 pcs

▶ COD: SLAKM001BL

Blister: 5.000 pezzi
Blister: 5.000 pcs

NERA NEUTRA
Black neutral

▶ COD: SLAKM002

Confezione: 20.000 pezzi
Package: 20.000 pcs

▶ COD: SLAKM002BL

Blister: 5.000 pezzi
Blister: 5.000 pcs

PROTEZIONE ADESIVA 0,7 X 4,4 CM KP
1,1 X 4,4 cm KP adhesive tag



FALSO BARCODE
Fake barcode

▶ **COD: SLAKP000**

Confezione: 20.000 pezzi
 Package: 20.000 pcs

▶ **COD: SLAKP000BL**

Blister: 5.000 pezzi
 Blister: 5.000 pcs

BIANCA NEUTRA
White neutral

▶ **COD: SLAKP001**

Confezione: 20.000 pezzi
 Package: 20.000 pcs

▶ **COD: SLAKP001BL**

Blister: 5.000 pezzi
 Blister: 5.000 pcs

NERA NEUTRA
Black neutral

▶ **COD: SLAKP002**

Confezione: 20.000 pezzi
 Package: 20.000 pcs

▶ **COD: SLAKP002BL**

Blister: 5.000 pezzi
 Blister: 5.000 pcs

PROTEZIONI PER SISTEMA ACUSTICO MAGNETICO
Acoustic magnetic system tags

PLACCA SUPERTAG GRIGIA
Grey super Tag



▶ **COD: HTA3001SUPT1**

Confezione: 1000 pezzi
 Package: 1000 pcs

PLACCA SUPERTAG2 GRIGIA
Grey super Tag2



▶ **COD: HTA3002SUPT2**

Confezione: 1000 pezzi
 Package: 1000 pcs

PLACCA BIGPEN GRIGIA
Grey BigPen tag



▶ **COD: HTA3010BIGP**

Confezione: 1000 pezzi
 Package: 1000 pcs

PLACCA MIDIPEN GRIGIA
Gey MidiPen tag



▶ **COD: HTA5001MIDP**

Confezione: 1000 pezzi
 Package: 1000 pcs

PLACCA TE5 SUPER Ø 5 CM
ø 5 cm TE5 super tag



▶ **COD: HTA8029TE5BLK** C: nero/black

▶ **COD: HTA8029TE5** C: grigio/grey

Confezione: 1000 pezzi
 Package: 1000 pcs

PLACCA RAGNO GRANDE Ø 7 CM
ø 7 cm black "Ragno" /Spider large tag



▶ **COD: HTA2701SWB2** D: Ø 7 cm

Confezione: 200 pezzi
 Package: 200 pcs

PLACCA RAGNO PICCOLO Ø 5 CM
ø 5,5 cm black, "Ragno"/Spider small



▶ **COD: HTA2501SWB2** D: Ø 5,5 cm

Confezione: 250 pezzi
 Package: 250 pcs

COLLARINO PER BOTTIGLIA MNPEN
MN Pen Bottle-collar tag



▶ **COD: HTA5301BOTLMN**

Confezione: 500 pezzi
 Package: 500 pcs

LACCETTO ACCIAIO RICOPERTO
Coated steel lace



▶ **COD: LYU17ACP** L: 17 cm

▶ **COD: LYU3001BCP** L: 30 cm

Confezione: 10000 pezzi
 Package: 10000 pcs

RADIOFREQUENZA

Radiofrequency systems

UNITÀ DISATTIVATORE CON PIATTO
Deactivator unit with base



► COD: DVR0282

DISTACCATORE SUPER CONICO
Super cone-shaped detacher



► COD: DTUCON00

DISTACCATORE SUPER ELEGANCE
Super Elegance Detacher



► COD: DTUELE00

PROTEZIONI ADESIVE PER SISTEMA RADIOFREQUENZA

Radiofrequency system adhesive protection

ETICHETTA ADESIVA HQ 2,9 X 2,6 CM
HQ 2,9 X 2,6 cm adhesive label



FALSO BARCODE
Fake barcode

► COD: SLR292600

Confezione: 20.000 pezzi
Package: 20.000 pcs

► COD: SLR292600BL

Blister: 2.000 pezzi
Blister: 2.000 pcs

BIANCA NEUTRA
White neutral

► COD: SLR292601

Confezione: 20.000 pezzi
Package: 20.000 pcs

► COD: SLR292601BL

Blister: 2.000 pezzi
Blister: 2.000 pcs

ETICHETTA ADESIVA HQ 3 X 3 CM
HQ 3 X 3 cm adhesive label



FALSO BARCODE
Fake barcode

► COD: SLR303000

Confezione: 20.000 pezzi
Package: 20.000 pcs

► COD: SLR303000BL

Blister: 2.000 pezzi
Blister: 2.000 pcs

BIANCA NEUTRA
White neutral

► COD: SLR303001

Confezione: 20.000 pezzi
Package: 20.000 pcs

► COD: SLR303001BL

Blister: 2.000 pezzi
Blister: 2.000 pcs

ETICHETTA ADESIVA HQ 4 X 3 CM
HQ 4 X 3 cm adhesive label



FALSO BARCODE
Fake barcode

► COD: SLR403000

Confezione: 20.000 pezzi
Package: 20.000 pcs

► COD: SLR403000BL

Blister: 2.000 pezzi
Blister: 2.000 pcs

BIANCA NEUTRA
White neutral

► COD: SLR403001

Confezione: 20.000 pezzi
Package: 20.000 pcs

► COD: SLR403001BL

Blister: 2.000 pezzi
Blister: 2.000 pcs

ETICHETTA ADESIVA HQ 4 X 4 CM
HQ 4 X 4 cm adhesive label



FALSO BARCODE
Fake barcode

► COD: SLR404000

Confezione: 20.000 pezzi
Package: 20.000 pcs

► COD: SLR404000BL

Blister: 2.000 pezzi
Blister: 2.000 pcs

BIANCA NEUTRA
White neutral

► COD: SLR404001

Confezione: 20.000 pezzi
Package: 20.000 pcs

► COD: SLR404001BL

Blister: 2.000 pezzi
Blister: 2.000 pcs

ETICHETTA ADESIVA STD 4 X 4 CM
STD 4 X 4 cm adhesive label



FALSO BARCODE
Fake barcode

▶ **COD: SLR404000-30**

Confezione: 20.000 pezzi
Package: 20.000 pcs

▶ **COD: SLR404000-30BL**

Blister: 2.000 pezzi
Blister: 2.000 pcs

BIANCA NEUTRA
White neutral

▶ **COD: SLR404001-30**

Confezione: 20.000 pezzi
Package: 20.000 pcs

▶ **COD: SLR404001-30BL**

Blister: 2.000 pezzi
Blister: 2.000 pcs

ETICHETTA ADESIVA HQ 5 X 5,2 CM
STD 5 X 5,2 cm adhesive label



FALSO BARCODE
Fake barcode

▶ **COD: SLR505000**

Confezione: 20.000 pezzi
Package: 20.000 pcs

▶ **COD: SLR505000BL**

Blister: 2.000 pezzi
Blister: 2.000 pcs

BIANCA NEUTRA
White neutral

▶ **COD: SLR505001**

Confezione: 20.000 pezzi
Package: 20.000 pcs

▶ **COD: SLR505001BL**

Blister: 2.000 pezzi
Blister: 2.000 pcs

ETICHETTA ADESIVA 4 X 4 CM "OFFERTA SPECIALE"
"Special Offer" 4 X 4 cm adhesive label



FREEZER

▶ **COD: SLR4040F06**

Confezione: 20.000 pezzi
Package: 20.000 pcs

▶ **COD: SLR4040F06BL**

Blister: 2.000 pezzi
Blister: 2.000 pcs

NO FREEZER

▶ **COD: SLR404006**

Confezione: 20.000 pezzi
Package: 20.000 pcs

▶ **COD: SLR404006BL**

Blister: 2.000 pezzi
Blister: 2.000 pcs

ETICHETTA ADESIVA 4 X 4 CM "CONFEZIONE FAMIGLIA"
"Family pack" 4 X 4 cm adhesive label



FREEZER

▶ **COD: SLR4040F21**

Confezione: 20.000 pezzi
Package: 20.000 pcs

▶ **COD: SLR4040F21BL**

Blister: 2.000 pezzi
Blister: 2.000 pcs

ETICHETTA ADESIVA 4 X 4 CM "CONSERVARE IN FRIGO"
"Store in the refrigerator" 4 X 4 cm adhesive label



FREEZER

▶ **COD: SLR4040F88-S**

Confezione: 20.000 pezzi
Package: 20.000 pcs

▶ **COD: SLR4040F88-SBL**

Blister: 2.000 pezzi
Blister: 2.000 pcs

ETICHETTA ADESIVA 4 X 4 CM NERA
Black adhesive label 4 X 4 cm

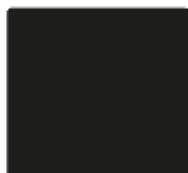

▶ **COD: SLR404002**

Confezione: 20.000 pezzi
Package: 20.000 pcs

▶ **COD: SLR404002BL**

Blister: 2.000 pezzi
Blister: 2.000 pcs

ETICHETTA ADESIVA 4 X 4 CM BIANCA
White adhesive label 4 X 4 cm



FREEZER

▶ **COD: SLR4040F01**

Confezione: 20.000 pezzi
Package: 20.000 pcs

▶ **COD: SLR4040F01BL**

Blister: 2.000 pezzi
Blister: 2.000 pcs

ETICHETTA ADESIVA 5 X 2,3 CM NERA
Black adhesive label 5 X 2,3 cm



▶ **COD: SLR502302**

Confezione: 20.000 pezzi
Package: 20.000 pcs

▶ **COD: SLR502302BL**

Blister: 2.000 pezzi
Blister: 2.000 pcs

ETICHETTA ADESIVA Ø 4 CM "PRODOTTO ITALIANO"
"Italian Product" adhesive label ø 4 cm



▶ **COD: SLRD4007**

Confezione: 20.000 pezzi
Package: 20.000 pcs

▶ **COD: SLRD4007BL**

Blister: 2.000 pezzi
Blister: 2.000 pcs

ETICHETTA ADESIVA HQ Ø 3,3 CM
HQ ø 3,3 cm adhesive label



FALSO BARCODE
Fake barcode

► COD: SLRD3300

Confezione: 20.000 pezzi
Package: 20.000 pcs

► COD: SLRD3300BL

Blister: 2.000 pezzi
Blister: 2.000 pcs

BIANCA NEUTRA
White neutral

► COD: SLRD3301

Confezione: 20.000 pezzi
Package: 20.000 pcs

► COD: SLRD3301BL

Blister: 2.000 pezzi
Blister: 2.000 pcs

ETICHETTA ADESIVA HQ Ø 4 CM
HQ ø 4 cm adhesive label



FALSO BARCODE
Fake barcode

► COD: SLRD4000

Confezione: 20.000 pezzi
Package: 20.000 pcs

► COD: SLRD4000BL

Blister: 2.000 pezzi
Blister: 2.000 pcs

BIANCA NEUTRA
White neutral

► COD: SLRD4001

Confezione: 20.000 pezzi
Package: 20.000 pcs

► COD: SLRD4001BL

Blister: 2.000 pezzi
Blister: 2.000 pcs

ETICHETTA ADESIVA Ø 4 CM "OFFERTA SPECIALE"
"Special Offer" ø 4 cm adhesive label



FREEZER

► COD: SLRD40F06

Confezione: 20.000 pezzi
Package: 20.000 pcs

► COD: SLRD40F06BL

Blister: 2.000 pezzi
Blister: 2.000 pcs

NO FREEZER

► COD: SLRD4006

Confezione: 20.000 pezzi
Package: 20.000 pcs

► COD: SLRD4006BL

Blister: 2.000 pezzi
Blister: 2.000 pcs

ETICHETTA ADESIVA TRASPARENTE HQ 1,5 X 5,2 CM
HQ 1,5 X 5,2 cm transparent adhesive label

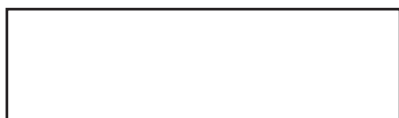

FREEZER

► COD: SLR155103

Confezione: 20.000 pezzi
Package: 20.000 pcs

► COD: SLR155103BL

Blister: 2.000 pezzi
Blister: 2.000 pcs

PROTEZIONI PER SISTEMA RADIOFREQUENZA
Radiofrequency system tags

PLACCA MINI NERA SUPER
Super black mini tag

PLACCA MINI NERA SUPER
Super black mini tag

PLACCA R50 SUPER
Super R50 tag



► COD: HTR8001MIN46 D: 4,2 x 4,6 cm

Confezione: 1000 pezzi
Package: 1000 pcs

► COD: HTR3005MIN52 D: 4,3 x 5,2 cm

Confezione: 1000 pezzi
Package: 1000 pcs

► COD: HTR8010R50BLK C: nero/black

► COD: HTR8010R50 C: grigio/grey
Confezione: 1000 pezzi
Package: 1000 pcs

PLACCA TE4 SUPER Ø 4 cm
Super TE4 tag Ø 4 cm



▶ COD: HTR8026TEBLK C: nero/black

▶ COD: HTR8026TE C: grigio/grey

Confezione: 1000 pezzi

Package: 1000 pcs

PLACCA TE4 SUPER Ø 5 cm
Super TE4 tag Ø 5 cm



▶ COD: HTR8029TEBLK C: nero/black

▶ COD: HTR8029TE C: grigio/grey

Confezione: 1000 pezzi

Package: 1000 pcs

PLACCA RAGNO GRANDE
Large Ragno/Spider tag, Ø 7 cm



▶ COD: HTR2701SWB2 D: Ø 7 cm

Confezione: 100 pezzi

Package: 100 pcs

PLACCA RAGNO PICCOLA
Ø 5,5 cm black, "Ragno"/Spider small



▶ COD: HTR2501SWB2 D: Ø 5,5 cm

Confezione: 250 pezzi

Package: 250 pcs

COLLARINO PER BOTTIGLIA
Bottle collar tag



▶ COD: HTR8301BOTL5 D: Ø 5 cm

Confezione: 500 pezzi

Package: 500 pcs

LACCETTO ACCIAIO RICOPERTO
Coated steel lace



▶ COD: LYU17ACP L: 17 cm

▶ COD: LYU3001BCP L: 30 cm

Confezione: 10.000 pezzi

Package: 10.000 pcs



Queue management
AND VIDEO COMMUNICATION

Gestione code e VIDEOCOMUNICAZIONE



*Gestisci le code
in maniera semplice e veloce*

MANAGE QUEUES QUICKLY AND EASILY



ELIMINACODE

Queue ticket dispenser

La nostra gamma di sistemi eliminacode permette di gestire le problematiche più complesse tipiche di strutture ricettive dotate di numerose postazioni di accoglienza, differenti aree di attesa, accessi multipli ecc, oppure permette il controllo di situazioni più semplici quali farmacie, punti vendita in generale, ambulatori medici, uffici comunali o di aziende di servizi, fino alla più semplice coda tipica di un comune punto vendita.

Our range of queue systems help handle the most complex problems of queue management in facilities with numerous reception stations, different waiting areas, multiple accesses etc. It helps in controlling queues in common situations such as in pharmacies, retail businesses, medical clinics, offices or in service companies. They can also manage the simple queue of a common retail business or more complex situations.





Vuoi migliorare e gestire i tempi di attesa dei tuoi clienti ? Affidati a Eliminacodeitalia, i veri professionisti per la gestione delle code. I nostri sistemi eliminacode rappresentano la giusta soluzione per la gestione delle file. Possono gestire facilmente una o più code e possono essere anche personalizzati su richiesta. Sono prodotti in Italia, sono affidabili e molto eleganti, sono tutti realizzati con materiali resistenti di altissima qualità. Disponiamo d'impianti mono e multi-sportello, mono e multi-servizio. Ogni sistema eliminacode si compone necessariamente di uno o più dispositivi di visualizzazione dello stato delle code, ed infine uno o più comandi per controllare lo stato delle code stesse. Per questi elementi essenziali offriamo varie soluzioni che si differenziano per performance e costo. La nostra offerta si completa con una serie di accessori che ci permettono di offrire un kit completo.



Would you like to improve and manage your customers' waiting time? If so, you should rely on the professional queue management staff of Eliminacodeitalia. Our queue management systems are the best solution for queuing. They can easily manage one or more queues and can be customized on request. They are produced in Italy, they are reliable, very elegant, and are all made of high quality resistant materials. Single and multi-door systems are available with single and multi-service solutions. All systems are equipped with one or more units showing all queue progresses; they are provided with one or more remotes and controls to handle queues. Thanks to these characteristics we have various solutions that differ in performances and costs. Our offer includes a wide range of accessories for a really complete kit.





CODALUX TOUCH *Modello A* Codalux Touch *Model A*

Codalux Touch Modello A è un distributore di ticket dal design elegante con un touch screen da 10" o 15", dotato di un'affidabile stampante termica che dispensa biglietti alfanumerici ed è in grado di regolare diversi flussi, a seconda dei differenti servizi erogati. Può gestire da una a più code, fino ad un massimo di dodici. Inoltre permette di visualizzare messaggi pubblicitari, offerte ed informazioni varie per la clientela. Tutti i prodotti si possono personalizzare e configurare su richiesta del cliente. Molto facile da gestire.

Codalux Touch Model A is a ticket dispenser with an elegant design with a 10" or 15" touch screen, equipped with a reliable thermal printer that dispenses alphanumeric tickets. It can handle different flows, depending on the different services provided. It can manage from one to twelve queues. At the same time it shows customers your ads, offers and various information. All products can be customized to satisfy customers' requests. Very easy to manage.

- ▶ COD: AVECT5Q Monitor 10"
- ▶ COD: AVECT5T Monitor 15"

Rotolo termico 80 x 80
Confezione da 50 pezzi
Cash rolls 80 x 80
Pack of 50 pcs



- ▶ COD: TER80X80CDX

COLORI/ COLOURS:

01 05

Monitor 10", 15"
Monitor 10", 15"



Stampa logo personalizzata
Customized logo print

Led colore fisso a scelta
Choice of fixed LED colour



Colore colonna personalizzabile
Customizable column colour





CODALUX TOUCH *Modello A Wall* Codalux Touch *Model A Wall*

Codalux Touch Modello A Wall è un distributore di ticket dal design elegante con un touch screen da 10" o 15", dotato di un'affidabile stampante termica che dispensa biglietti alfanumerici ed è in grado di regolare diversi flussi, a seconda dei differenti servizi erogati. Può gestire da una a più code, fino ad un massimo di dodici. Inoltre permette di visualizzare messaggi pubblicitari, offerte ed informazioni varie per la clientela. Tutti i prodotti si possono personalizzare e configurare su richiesta del cliente. Molto facile da gestire.

Codalux Touch Model A Wall is a ticket dispenser with an elegant design with a 10 "or 15" touch screen, equipped with a reliable thermal printer that dispenses alphanumeric tickets. It can handle different flows, depending on the different services provided. It can manage from one to twelve queues. At the same time it shows customers your ads, offers and various information. All products can be customized to satisfy customers' requests. Very easy to manage.

Supporto salvaspazio

Staffa di appoggio da fissare alle pareti. Utile quando non si vuole occupare spazio su pavimento.

SPACE-SAVING HOLDER

Bracket holder to be fixed on walls. Useful to save floor space.

▶ COD: AVECT10P

Monitor 10"
COLORI/ COLOURS:

01 05

▶ COD: AVECT5P15

Monitor 15"
COLORI/ COLOURS:

05

Rotolo termico 80 x 80
Confezione da 50 pezzi
Cash roll 80 x 80
Pack of 50 pcs



▶ COD: TER80X80CDX

Monitor
10", 15"
Monitor
10", 15"



Stampa logo personalizzata
Customized logo print



Staffa 20 x 13 cm
20 x 13 cm bracket

▶ COD: AVECTSTFE

COLORI/ COLOURS:

01 05



CODALUX TOUCH *Modello B* Codalux Touch *Model B*

Codalux Touch Classe B è un distributore di ticket dal design elegante con un touch screen da 15", 17", 22", 24", 27", 32" dotato di stampante termica che dispensa biglietti alfanumerici ed è in grado di regolare diversi flussi. Può gestire fino ad un massimo di dodici code. Permette di visualizzare messaggi pubblicitari, offerte ed informazioni varie. Tutti i modelli possono essere usati come semplici punti informativi anche senza la stampante. Alcune versioni (quelle che terminano con V) possono avere il monitor verticale.

Codalux Touch Class B is an elegant designed ticket dispenser with a 15", 17", 22", 24", 27" or 32" touch screen equipped with thermal printer which dispenses alphanumeric tickets. It manages different flows, up to a maximum of twelve. It shows advertisements, offers and various information. All models can be used as simple information points even without the printer. Some versions (those ending with V) may have a vertical monitor.

▶ COD: AVECT5B15H	Monitor 15"
▶ COD: AVECT5B17H	Monitor 17"
▶ COD: AVECT5B22H	Monitor 22"
▶ COD: AVECT5B22V	Monitor 22"
▶ COD: AVECT5B24H	Monitor 24"
▶ COD: AVECT5B24V	Monitor 24"
▶ COD: AVECT5B27H	Monitor 27"
▶ COD: AVECT5B32H	Monitor 32"

Rotolo termico 60 x 60
Confezione da 50 pezzi
Cash roll 60 X 60
Pack of 50 pcs



▶ COD: TER60X60CDX

COLORI/ COLOURS:

01

05

Monitor
15", 17", 22", 24", 27", 32"
Monitor
15", 17", 22", 24", 27", 32"

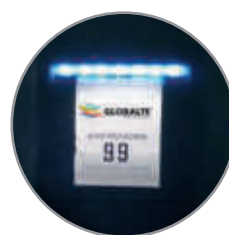

Stampa logo personalizzata
Customized logo print

Led colore fisso a scelta
Choice of LED fixed colour



Colore colonna personalizzabile
Column colour customizable





CODALUX

Codalux

Il Codalux a pulsanti è un distributore di ticket dal design elegante. Le linee essenziali ed il design moderno lo rendono particolarmente adatto ad essere usato anche come elemento di arredo. Può gestire da una a più code. Il nostro distributore è equipaggiato con un'affidabile stampante termica dotata di taglierina automatica per il rilascio del biglietto, ad accesso protetto, e i rotoli usati sono i termici 60x60. Colore della colonna : nera, bianca o altri colori su richiesta (con 1 / 2 / 3 / 4 tasti). Molto facile da gestire.

The Codalux with buttons is a ticket dispenser with an elegant design. Its clean shape and modern design make it suitable to be used also as "a piece of furniture". It can manage from one to more queues. Our distributor is equipped with a reliable thermal printer and an automatic ticket release cutter, with protected access; and the thermal rolls used are 60x60. Column colours: black, white or other colours on request (with 1/2/3/4 keys). Very easy to manage

- ▶ COD: CPSPJD01 1 Pulsante
1 Button
- ▶ COD: CPSPJD02 2 Pulsanti
2 Buttons
- ▶ COD: CPSPJD03 3 Pulsanti
3 Buttons
- ▶ COD: CPSPJD04 4 Pulsanti
4 Buttons

Rotolo termico 60 x 60
Confezione da 50 pezzi
Cash roll 60 X 60
Pack of 50 pcs



▶ COD: TER60X60CDX

COLORI/ COLOURS:

01 05

Pulsanti multipli
Multiple buttons



Stampa logo personalizzata
Customized logo print

Led colore fisso a scelta
Choice of fixed LED colour

Colore colonna personalizzabile
Customizable column colour



DISTRIBUTORI DI TICKET

Ticket dispenser

Erogatore manuale di ticket a chiocciola

E' un semplicissimo distributore di ticket cartacei numerati progressivamente, mono servizio, fissabile a muro o su piantana da pavimento.

Manual ticket dispenser

It is a very simple dispenser of progressively numbered paper tickets, one at a time, wall-mounted or on floor standing.

Erogatore manuale di ticket a leva

E' un distributore di ticket a leva e la sua particolarità è dovuta alla meccanica presente che consente la fuoriuscita di un solo numero per volta progressivamente, mono servizio, fissabile a muro o su piantana da pavimento.

Manual lever ticket dispenser

It is a lever ticket dispenser with a peculiar mechanics which allows the release of one number at a time, single service, to be mounted on wall or stand on floor.

COD: AVECCH01

COLORI/ COLOURS:

02

03

06

07



Distributore a chiocciola VX1.
VX1 ticket dispenser.

COD: AVECCH03

COLORI/ COLOURS:

05

06



Distributore a leva VX3.
VX3 dispenser with lever.

COD: AVECCH0405



Supporto da parete per VX3. Materiale: FE
Wall holder for VX3. Made of: FE

TICKET ADATTI AL DISTRIBUTORE VX1
Tickets suitable for the VX1 distributor



Ticket numerici
Numeric ticket

Conf. 40 rotoli
Box of 40 rolls

► COD: AVECT140

Conf. 5 rotoli
Box 5 rolls

► COD: AVECT105



Ticket alfanumerici
Alphanumeric ticket

Conf. 40 rotoli
Box of 40 rolls

► COD: AVECT240

Conf. 15 rotoli
Box of 15 rolls

► COD: AVECT205

TICKET ALFANUMERICI ADATTI AL DISTRIBUTORE VX3
Alphanumeric tickets suitable for the VX3 distributor



Conf. 10 rotoli
Box of 10 rolls

► COD: AVECT310

Conf. 15 rotoli
Box of 15 rolls

► COD: AVECT315

CARTELLO INFORMATIVO BIFACCIALE COMPLETO DI CORNICE
Two-sided information sign with frame



► COD: AVECVP04

RACCOGLITORE TICKET IN PLEXIGLASS
Plexiglass ticket collector



Con clip a chiocciola
With spiral clip

► COD: AVECRT0208

Con ventose
With suction cups

► COD: AVECRT0108

Con mollettone
With clip

► COD: AVECRT0308

DISTRIBUTORI DI TICKET: PIANTANE PER VX1 E VX3

Ticket dispenser: free standing stands for vx1 and vx3

Asta in metallo per distributore ticket con cartello istruzioni cliente che indica dove ritirare il proprio numero
Metal rod for ticket dispenser with instruction sign for customers.



► COD: AVECVP0105

► COD: AVECVP0205

► COD: AVECVP0305



Piantana VP1.
 H: 140 cm
VP1 free standing stand. H: 140 cm



Piantana VP2.
 H: 135 cm
VP2 free standing stand. H: 135 cm



Piantana VP3.
 H: 134 cm
VP3 free standing stand. H: 134 cm

Esempio di distributore di ticket
Example of ticket dispenser with stand

Logo e nome dell'Attività
 Logo and name of the company



Visualizzazione delle chiamate
 Display of calls

Ultime notizie (RSS)
 Latest news (RSS)

BOX ELIMINACODE MULTIMEDIALE

Multimedia queue ticket dispenser box



▶ COD: AVECSBLX05



▶ COD: AVECRC0405

Box multimediale di gestione delle code rivolto a farmacie, studi medici, ambulatori, aziende ospedaliere, studi professionali, strutture pubbliche, supermercati e tanti altri settori. Può gestire da una a "n" code, definite dall'utente, permette la visualizzazione di video, immagini, slide, grafici, avvisi in tempo reale, news dal mondo esterno (notizie, meteo, curiosità, etc), può gestire l'avanzamento delle code via LAN da PC o con telecomando RF dedicato per ogni singola coda.

Permette l'inserimento di immagini e video in tempo reale e la modifica del layout grafico, in termini di definizione di posizioni, dimensione delle aree e scelta dei colori e delle scritte. Facilissimo da usare, va posizionato dietro al monitor/TV, va alimentato con un alimentatore a 220 Vac (in dotazione) e va collegato con un semplice cavo HDMI. A questo sistema si possono collegare anche più monitor/TV.

Multimedia queue management box for pharmacies, doctors' surgeries, clinics, hospitals, professional offices, public facilities, supermarkets, and many other sectors. It can manage from one to "n" queues, set by the user. It can show videos, images, slides, graphics, real-time alerts, news from the outside world (news, weather, curiosity, etc.), it can manage the queue progress via LAN from PC or with dedicated RF remote control for each queue.

It is possible to insert images or videos in real time and to change both definition and position of the graphic layout, of the size of the areas or the choice of colours and writings. Very easy to use, it must be positioned behind the monitor/ TV, it must be powered with a 220Vac power supply (included) and has to be connected via a simple HDMI cable. Multiple monitors / TVs can also be connected to the same system.



VISORI GESTIONE CODE

Queue management displays

Caratteristiche:

VD1 - Visore a led modello VD1 a due cifre alte 120mm, completo di staffa di montaggio. Materiale ABS. Alimentazione VAC/VDC. A questo visore è possibile applicare un sistema vocale wireless.

VD3 - Visore a led modello VD3 a due cifre alte 120mm, completo di staffa di montaggio. Materiale ABS. Alimentazione VAC/VDC. A questo visore è possibile applicare un sistema vocale via cavo.

Features:

VD1 - Model VD1 LED display with two 120mm high digits, complete with mounting bracket. ABS material. VAC / VDC power supply. A wireless voice system can be applied to this display.

VD3 - Model VD3 LED display with two 120mm high digits, complete with mounting bracket. ABS material. VAC / VDC power supply. It is possible to apply a voice system via cable to this display.



COD: AVECDP01
VD1

COLORI/ COLOURS:



COD: AVECDP03
VD3

COLORI/ COLOURS:



Staffa orientabile
Collegamento wireless in serie
Collegamento via cavo di più visori
Avanzamento con pulsante
Visore 12-24 V per ambulanti
Sistema vocale wireless
Sistema vocale via cavo

VD1 VD3

SI	SI
SI	NO
optional	SI
optional	SI
optional	NO
SI	NO
optional	SI

Adjustable bracket
Wireless connection in series
Cable connection of multiple viewers
Advance with button
12-24 V display for street vendors
Wireless voice system
Cable voice system

VD1 VD3

SI	SI
SI	NO
optional	SI
optional	SI
optional	NO
SI	NO
optional	SI



COD: AVECRC01

Radiocomando modello VT1 per visore VD1
VT 1 remote control for VD1 display



COD: AVECRC02

Radiocomando modello VT2 con display LCD a 2 cifre per visore VD1
VT 2 remote control with 2-digit LCD display for VD1 display



COD: AVECRC03

Radiocomando modello VT3 per visore VD3
VT 3 r remote control for VD3 display



COD: AVECRC05

Modello VTVS per visore compatibile
VTVS model for compatible display

COD: AVECMT01

Staffa trifacciale
Three sided bracket



COD: AVECSV0105

Sistema vocale VD1
VD1 Voice control



COD: AVECSV0205

Sistema vocale VD3
VD3 Voice control

ACCESSORI: DELIMITATORI

Accessories: columns for queues

COLONNINA TENDINASTRO
Column with belt

COLORI NASTRO:
Belt colours:



- Cromo
Chrome
- ▶ COD: SPCR D: 91 H cm
- Silver
- ▶ COD: SP803 D: 91 H cm
- Nero
Black
- ▶ COD: SP913 D: 91 H cm

RULLO TENDINASTRO A MURO
Wall belt tensioner roller

COLORI NASTRO:
Belt colours:



- Cromo
Chrome
- ▶ COD: RUCR
- Silver
- ▶ COD: RU803
- Nero
Black
- ▶ COD: RU913



- Attacco di partenza
o finale a muro
*Starting or final
holder on the wall*
- ▶ COD: ATTMUR

DELIMITATORE A CORDONE
Columns with rope

COLORI CORDA:
Rope colours:



- Cromo
Chrome
- ▶ COD: SPCR D: 91 H cm

INSEGNA PUBBLICITARIA PER COLONNINA
Advertising sign for column



- ▶ COD: BRDSY040070 D: 40 x 75 H cm



SOFTWARE GESTIONALI E SISTEMI INFORMATIVI PERSONALIZZABILI

*Management software and
customizable information systems*



▶ COD: AVECSBDS05



▶ COD: AVECSBMC05

I nostri sistemi di video comunicazione si adattano a tutte le tipologie di attività: farmacie, supermercati, pasticcerie, gelaterie, studi medici, banche, punti vendita in generale. GLOBALTESHOP è la giusta soluzione di digital signage per arricchire di contenuti digitali e servizi la tua attività. Il software è un applicativo avanzato, sviluppato appositamente per supportare in modo organico, automatico e sicuro la distribuzione dell'informazione e della comunicazione in-store. Il software GLOBALTESHOP applicato a monitor, TV o totem interattivi può:

- Gestire messaggi promozionali;
- Fornire informazioni sui prodotti;
- Gestire le code;
- Gestire il libro ingredienti;
- Gestire i prezzi per tipologia di reparto;
- Visualizzare menù nei ristoranti, gastronomie e pizzerie;
- Molto altro ancora!

L'interfaccia è molto intuitiva e la grafica è personalizzabile, può essere installato in diverse configurazioni hardware e si può scegliere la più adatta alle Vostre esigenze.

Our video communication systems are suitable for all kinds of activities: pharmacies, supermarkets, pastry shops, ice cream parlors, doctors, banks, retail outlets, etc. GLOBALTESHOP is the right digital signage solution to enhance your business with digital content and services. The Software is an advanced application system, specifically developed to support the distribution of information and in-store communication in a logic, automatic and safe way. The GLOBALTESHOP Software applied to monitors, TVs or interactive totems can:

- *Manage promotional messages;*
- *Provide product information;*
- *Manage queues;*
- *Manage the ingredients book;*
- *Manage prices according to different departments;*
- *Display menus in restaurants, delicatessens and pizzerias;*
- *And much more!*

The interface is very intuitive and the graphics are customizable, it can have different hardware configurations and you can choose the most suitable for your needs.



VIDEOCOMUNICAZIONE PREZZI



Video communication prices

Gestisci tutta la tua comunicazione e scopri come è semplice cambiare i prezzi ai prodotti o realizzare le offerte del momento.

Il nostro software e i nostri sistemi espositivi sono uno strumento efficace di promozione dei prezzi all'interno del reparto. Attraverso l'installazione del nostro sistema puoi proporre ai tuoi clienti un modo innovativo di visualizzare i prodotti e i relativi prezzi sfruttando una strategia di marketing moderna e innovativa.

Manage all your advertising system and your communication, finding out how simple it is to change product prices or make current offers.

Our software and our display systems are very successful tools which can promote prices within the department. Installing our system you can offer your customers an innovative way to see products and their prices using a modern and innovative marketing strategy.

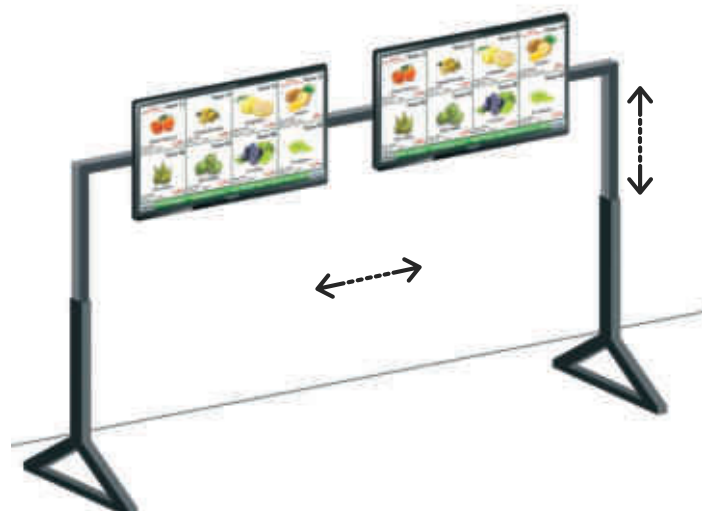

MONITOR PROFESSIONALI PER COMUNICARE

Professional monitors to communicate

PHILIPS DISPLAY 65" Q-LINE



▶ COD: GCMPPH01

65", 4K formato 16:9 - Ris: 3840x2160.
350 cd/m²- VGA - cavo DVI doppia uscita
- display port - HDMI (2.0) Vesa Mount
400x400 e 200x400 (M6)
65", 4K 16:9 format - Res: 3840x2160.
350 cd / m² - VGA - dual output DVI cable
- port display - HDMI (2.0) Vesa Mount
400x400 and 200x400 (M6)

PHILIPS DISPLAY 75" Q-LINE



▶ COD: GCMPPH02

75", 4K formato 16:9 - Ris: 3840x2160.
410 cd/m²- VGA, display port (1,2),
HDMI (x4) - Vesa Mount 600x400 (m8)
75", 4K 16:9 format - Res: 3840x2160.
410 cd / m² - VGA, display port (1,2),
HDMI (x4) - Vesa Mount 600x400 (M8)

PHILIPS DISPLAY H-LINE 55"



▶ COD: GCMPPH03

55"- Direct led full HD 1920x1080 slim.
Bezel display 2500 cd/m²- Ultra high
brightness
55"- Direct led full HD 1920x1080 slim.
2500 cd / m² display bezel - Ultra high
brightness

PHILIPS DISPLAY H-LINE 75"



▶ COD: GCMPPH04

75" direct led UHD 3840x2160 - 4K
direct led slim bezel display 3000 cd/m² -
Ultra high brightness
75" direct led UHD 3840x2160 - 4K
direct led slim bezel display 3000 cd / m² -
Ultra high brightness

PHILIPS DISPLAY VIDEO WALL 49"



▶ COD: GCMPPH05

49"- 450 nits full HD- 16:9 -
Ris: 1920x1080 - Bezel ultra slim
tot. 3,5 mm
49" - 450 nits full HD - 16: 9 -
Ris: 1920x1080 - Ultra slim Bezel
tot. 3.5 mm

PHILIPS DISPLAY VIDEO WALL 55"



▶ COD: GCMPPH06

55"- 500 nits full HD- 16:9 -
Ris: 1920x1080 - Bezel ultra slim
tot. 3,5 mm
55" - 500 nits full HD - 16: 9 -
Ris: 1920x1080 - Ultra slim Bezel
tot. 3.5 mm

PHILIPS VIDEO WALL 49"



▶ COD: GCMPPH07

49"- 700 nits full HD- 16:9 -
Ris: 1920x1080 - Bezel ultra slim
tot. 3,5 mm
55" - 700 nits full HD - 16: 9 -
Ris: 1920x1080 - Ultra slim Bezel
tot. 3.5 mm

PHILIPS VIDEO WALL 55"



▶ COD: GCMPPH08

55"- 500 nits full HD- 16:9 -
Ris: 1920x1080 - Bezel ultra slim
tot.1,8 mm
55" - 500 nits full HD - 16: 9 -
Ris: 1920x1080 - Ultra slim Bezel
tot. 1,8 mm

PHILIPS VIDEO WALL 55"



▶ COD: GCMPPH09

55"- 700 nits full HD- 16:9 -
Ris: 1920x1080 - Bezel ultra slim
tot. 1,8 mm
55" - 700 nits full HD - 16: 9 -
Ris: 1920x1080 - Ultra slim Bezel
tot. 1,8 mm

TV LED

TV led

TV LED 24"



▶ COD: GCTLEC01

Dimensione schermo 24" - 16:9 (60cm)
 Risoluzione 1366 x 768
 Retroilluminazione a led - tipo DLED
 Screen size 24" - 16: 9 (60cm)
 Resolution 1366 x 768
 LED backlight - DLED type

TV LED 32"



▶ COD: GCTLEC02

Dimensione schermo 32" - 16:9 (81cm)
 Risoluzione 1366 x 768
 Retroilluminazione a led - tipo DLED
 Screen size 32" - 16: 9 (81 cm)
 Resolution 1366 x 768
 LED backlight - DLED type

TV LED 40"



▶ COD: GCTLEC03

Dimensione schermo 40" - 16:9 (101cm)
 Risoluzione 1920 x 1080 (Full HD)
 Retroilluminazione a led - tipo DLED
 Screen size 40" - 16: 9 (101cm)
 1920 x 1080 resolution (Full HD)
 LED backlight - DLED type



TOTEM TOUCH SCREEN MENÙ

I nostri totem touch screen sono eleganti e poco ingombranti, consentono di visualizzare menù di pizzerie, gelaterie, pasticcerie e bar.... Questi speciali totem possono essere configurati sia in orizzontale che in verticale e gli schermi touch screen sono di diversi formati. Con i nostri totem cambia positivamente l'immagine del tuo punto vendita in maniera forte e innovativa. La gestione dei contenuti e i listini prezzi possono essere gestiti facilmente in remoto attraverso una specifica applicazione da noi fornita. Alcune versioni (quelle che terminano con V) possono avere il monitor verticale.

Our touch screen totems are elegant and space-saving, allow you to show menus and much more in pizzerias, ice cream parlors, pastry shops and bars These special totems can be either horizontal or vertical. Their touch screens can have different sizes. Our totems will enhance the image of your store in a positive and innovative way. Content management and price lists can be easily handled remotely by the specific application provided. Some versions (those ending with V) may have a vertical monitor.

- ▶ COD: AVECT5M15H Monitor 15"
- ▶ COD: AVECT5M17H Monitor 17"
- ▶ COD: AVECT5M22H Monitor 22"
- ▶ COD: AVECT5M22V Monitor 22"
- ▶ COD: AVECT5M24H Monitor 24"
- ▶ COD: AVECT5M24V Monitor 24"
- ▶ COD: AVECT5M27H Monitor 27"
- ▶ COD: AVECT5M32H Monitor 32"

COLORI/ COLOURS:

01

05

Monitor
15", 17", 22", 24", 27", 32"
Monitor
15", 17", 22", 24", 27", 32"



Colore colonna personalizzabile
Customizable column colour



LIBRO INGREDIENTI

Ingredient Book

Da qualche tempo in molti punti vendita sono installati i nostri TOTEM CODALUX TOUCH con il software GLOBALTESHOP per gestire il libro ingredienti in formato digitale. Infatti quando si fa la spesa, sapere cosa si sta acquistando è importante, soprattutto per capire se sono presenti allergeni o ingredienti che dobbiamo evitare per la nostra dieta. I nostri prodotti sono la giusta soluzione digitale per gestire il libro degli ingredienti in modo centralizzato e in tempo reale. Con semplici operazioni fatte da remoto, si possono tenere aggiornati tutti libri ingredienti dei Vostri prodotti. Il software applicato ai nostri prodotti per il libro ingredienti è molto affidabile ed è dotato di una grafica intuitiva e chiara; in più può offrire altri contenuti in tema di comunicazione alla clientela, ad esempio si può gestire la cantina dei vini, le ricette e tante altre cose ancora. Disponiamo di diversi formati video. Colore colonna standard nero, su richiesta sono disponibili altri colori. Chiamateci per ulteriori informazioni.

In many stores you may find our TOTEM CODALUX TOUCH instilled with the GLOBALTESHOP software to manage the ingredient book in digital format. It is important to know what kind of food you are buying, especially when you are allergic or when you need to avoid ingredients. Some our products are the right digital solution to manage the ingredient book in a centralized and real-time manner. With simple remote operations you can update all the ingredients of your products. The software applied to our products for the ingredient book is very reliable and has an intuitive and clear graphic. Moreover it can communicate other contents to customers, such as the wine cellar, the recipes and much more. We have different screen sizes. Standard column colour is black, but other colours are available on request. Pleas call us for more information.



APPLICAZIONI PER LA RISTORAZIONE E IL FOOD IN GENERALE

Applications for catering and food in general

Oggi nel settore della ristorazione e del food si richiede sempre di più la digitalizzazione delle informazioni sui prodotti e sui menù. I nostri sistemi trasformeranno il vostro locale in un contesto moderno e permetteranno di gestire in tempo reale tutti i vostri contenuti quali menù, listini prezzi, video, immagini, animazioni e testi all'interno di un palinsesto personalizzabile che potete gestire direttamente. La visualizzazione sui nostri sistemi sarà in grado di dare risalto a tutte le vostre proposte con stile e design.

Nowadays restaurants and food sector in general look for more and more detailed and digitalized information about products and menus. Our systems will make your restaurant a modern context allowing you to manage all your content in real time. It can handle menus, price lists, videos, images, animations and texts within a customizable schedule directly managed by you. The visualization on our systems will be able to emphasize all your proposals with style and design.



VIDEOWALL LED MENU

Videowall led menu

I nostri videowall led, consentono di visualizzare, in alta definizione, i menù di pizzerie, gelaterie, pasticcerie, bar. Questi speciali monitor possono essere configurati in modo particolare, dando una chiara immagine del tuo punto vendita in maniera forte, innovativa ed originale. La gestione dei contenuti e i listini prezzi possono essere gestiti da remoto attraverso una specifica applicazione da noi fornita.

Our LED video walls show menus of pizzerias, ice cream parlors, pastry shops and coffee shops in high definition. These special monitors can be prepared in order to give a powerful image of your store in an innovative and original way. We can provide you a specific application to manage content and price lists on remote mode.

BANNER MONITOR LED MENU

Banner monitor led menu

Disponiamo di speciali monitor a led che consentono di visualizzare i menù di pizzerie, gelaterie, pasticcerie e bar... Questi sistemi possono essere appesi con cavi d'acciaio sopra il banco o attaccati alla parete o posizionati davanti le vetrine. La gestione dei contenuti e i listini prezzo possono essere gestiti da remoto direttamente.

We have special LED monitors that can show menus of pizzerias, ice cream parlors, pastry shops and coffee shops... These systems can be hung with steel cables above the bench or attached onto the wall or can be put in front of windows. Content management and price lists can be directly managed remotely.

MONITOR LCD MENU

Monitor lcd menu

I nostri monitor forniscono un'eccellente visualizzazione in ambienti ad elevata luminosità. Grazie alla qualità del contrasto e ai colori naturali, riproducono contenuti video e immagini in maniera perfetta. Alta luminosità e ultime tecnologie elettroniche garantiscono un funzionamento prolungato. Sono garantiti per affidabilità e qualità. Questi monitor prevedono la gestione dei contenuti da remoto in maniera semplice ed intuitiva.

Our monitors can grant excellent visualization even in highly brightened settings. Thanks to contrast and natural colour quality, they perfectly play video content and images. High brightness and the latest electronic technologies ensure extended operation quality, being highly reliable. These monitors provide remote content management in a simple and intuitive manner.



SOFTWARE E NUOVE TECNOLOGIE

Software and New Technologies

Da diversi anni offriamo ai nostri clienti le nostre competenze nel settore dell'Information Technology, a partire dalle soluzioni software e hardware per la comunicazione visiva nei punti vendita.

Proponiamo solo prodotti di qualità e soluzioni personalizzate.

Il cliente viene aiutato a trovare la soluzione più adatta alle sue esigenze e integrarla, se necessario con le infrastrutture preesistenti o personalizzarla.

Il team di GLOBALTE è competente e preparato ed è in grado di fornire consulenza e assistenza tecnica in ogni ambito tecnologico da noi sviluppato.

We have been offering our customers our expertise in the Information Technology sector for several years now, with software and hardware solutions for visual communication in sales points.

We offer only quality products and customized solutions. We help every and each customer showing them the best tailored solution to their needs. Whenever needed we can integrate our solutions to pre-existing or customized infrastructures.

The GLOBALTE team is highly skilled and ready to provide any possible suggestion or technical assistance in any technological area.



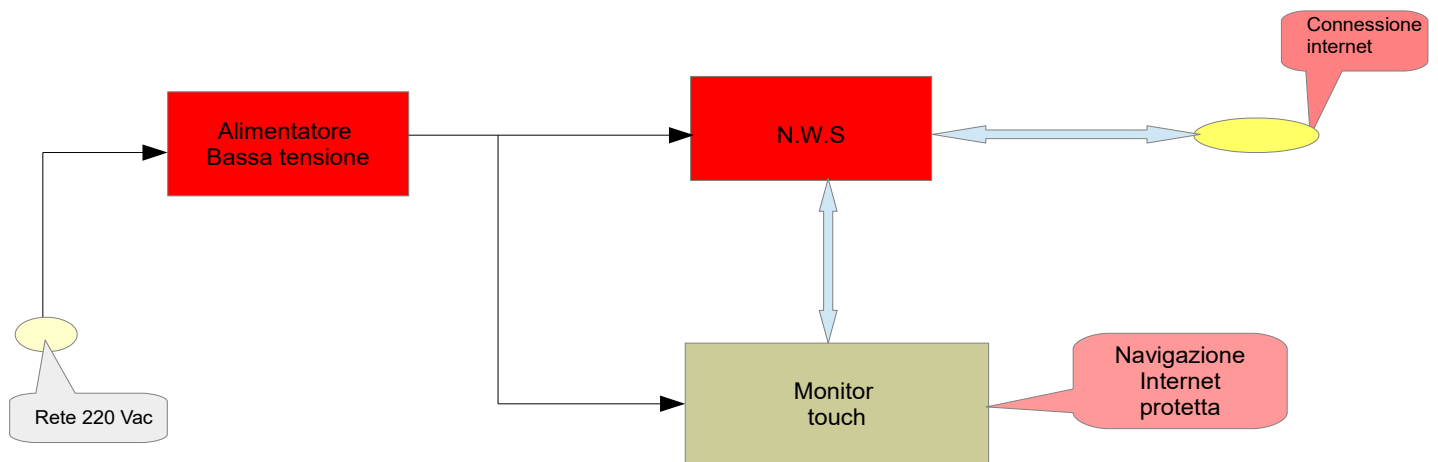

APP. N.W.S. (NAVIGATOR WEBSITE SOFTWARE)

APP. N.W.S. (Navigator Website Software)



Disponiamo di sistemi hardware e programmi software per far girare solo ed esclusivamente il vostro sito web su dispositivi interattivi multimediali come monitor, TV, professional monitor, monitor videowall e totem touch screen, telefonini e pc. Questi programmi sono ideali sia per uso privato che per attività commerciali, inoltre possono essere usati per musei, chiese, pubblica amministrazione.

Il Digital Signage come applicazione pura ha, infatti, sempre evitato "contaminazioni" con altre tecnologie e utilizzi perché questi ultimi possono essere fonte di "distrazione" rispetto allo scopo principale. Con gli schermi touch che permettono la navigazione su internet c'è poi la necessità di evitare che un utilizzatore visiti altri siti (magari anche di dubbio gusto o a rischio virus informatici) costringendo quindi a continui restart delle attrezzature. D'altro lato è però un peccato non permettere la navigazione interattiva in modo che un visitatore possa informarsi su quello che più gli interessa in una determinata presentazione. L'HW di facilissima installazione e il SW che proponiamo risolvono completamente questo problema e quindi non è più necessario costruire versioni "blindate" dei propri siti e inoltre è possibile collegare il proprio sistema anche a siti di pubblica utilità o informativi (come quelli degli enti turistici) senza nessun rischio.









We have hardware systems and software programs to run your website exclusively on interactive multimedia devices such as monitors, TVs, professional monitors, video wall monitors and touch screen totems, mobile phones and PCs. These programs are ideal both for private use and commercial activities. They can be used for museums, churches, public administration too.

The Digital Signage as a pure application has, in fact, always avoided "contamination" with other technologies and uses because the latter can be a source of "distraction" with respect to the main purpose. With touch screens that allow the surfing on internet, there is the need to prevent a user from visiting other sites (maybe of dubious taste or a computer virus) thus forcing a continuous restart of the equipment. On the other side it is not good to prevent interactive browsing. The very easy installation of our HW and its SW completely solves this problem and therefore it is no longer necessary to build closed versions of sites. It is also possible to connect your system to public utility or information sites (such as those of institutions tourism) without any risk.

DESCRIZIONE MATERIALI

MATERIALE	SIGLA	DURATA	RESISTENZA	ASPETTO ESTERIORE	TEMP. MAX	DESCRIZIONE
Acrilico	ACR	Eccellente resistenza alla rottura	Medio-alta	Eccellente	85°	Materiale molto duro, adatto per una varietà di usi
ABS	ABS	Infrangibile	Medio-alta	Molto buono	85°	Materiale robusto con lunga durata. Perfetto per assolvere funzionalità di resistenza.
SAN	SAN	Resistente alla rottura	Medio-alta	Eccellente	70°	Materiale trasparente per applicazioni industriali. Eccellente risultato estetico.
ABS + Acrilico	3FLEX	Resistente alla rottura	Alta	Eccellente	85°	Ha per caratteristiche la resistenza dell' ABS e la qualità dell'aspetto estetico dell'acrilico.
Policarbonato	PC	Infrangibile	Molto Alta	Molto buono	130°	Materiale infrangibile con resistenza alla superficie molto alta. Perfetto per cucchiari e pinze.
Polipropilene	PP	Infrangibile	Media	Buono	65°	Materiale estremamente versatile. Idoneo ai più vari utilizzi.
Polietilene	PE	Infrangibile	Media	Buono	65°	Materiale estremamente versatile. Idoneo ai più vari utilizzi.
Melamina	CM	Resistente alla rottura	Molto Alta	Eccellente	120°	Materiale termoindurente dalle proprietà estetiche.
Metacrilato	PMMA	Resistente alla rottura	Alta	Eccellente	70°	Materiale con alta resistenza e caratteristiche estetiche eccellenti.
Acciaio	ST	/	/	/	/	Prodotti estremamente forti e durevoli nel tempo. Resistente alle alte temperature.
Acciaio Inox	STS	/	/	/	/	Materiale che permette di unire la bellezza inossidabile con la progettazione creativa.
Bamboo	BAM	Resistente alla rottura	Molto Alta	Eccellente	/	Bamboo naturale con laccatura protettiva compatibile con contatto di prodotti alimentari.
Perplex	PC	Infrangibile	Molto Alta	Molto buono	130°	Materiale infrangibile con resistenza alla superficie molto alta. Perfetto per cucchiari e pinze.
Symbioplex	PMMA/ABS	Infrangibile	Molto Alta	Molto buono	130°	Materiale con caratteristiche del metacrilato e dell'ABS.
PETG	PETG	Infrangibile	Media	Buono	70°	Utilizzato specificamente quando serve un materiale trasparente e indistruttibile.

MATERIAL DESCRIPTION

MATERIAL	SIGN	LIFE	RESISTANCE	APPEARENCE	TEMP. MAX	DESCRIPTION
Acrylic	ACR	Excellent resistance at break	Medium-high	Excellent	85°	Very hard material, suitable for a variety of uses
ABS	ABS	Unbreakable	Medium-high	Very good	85°	Robust material with long life. Perfect for carrying out resistance functions.
SAN	SAN	Resistant to breakage	Medium-high	Excellent	70°	Transparent material for industrial applications. Excellent aesthetic result.
ABS + Acrylic	3FLEX	Resistant to breakage	High	Excellent	85°	Its characteristics are the resistance of ABS and the quality of the aesthetic appearance of the acrylic.
Polycarbonate	PC	Unbreakable	Very high	Very good	130°	Unbreakable material with very high surface resistance. Perfect for spoons and pliers.
Polypropylene	PP	Unbreakable	Medium	Good	65°	Extremely versatile material. Suitable for various uses.
Polyethylene	PE	Unbreakable	Medium	Good	65°	Extremely versatile material. Suitable for various uses.
Melamine	CM	Resistant to breakage	Very high	Excellent	120°	Thermosetting material with aesthetic properties.
Methacrylate	PMMA	Resistant to breakage	High	Excellent	70°	Material with high resistance and excellent aesthetic characteristics.
Steel	ST					Extremely strong and long lasting products. Resistant to high temperatures.
Stainless steel	STS					Material that allows you to combine stainless beauty with creative design.
Bamboo	BAM	Resistant to breakage	Very high	Excellent		Natural bamboo with protective lacquer compatible with food contact.
Perplex	PC	Unbreakable	Very high	Very good	130°	Unbreakable material with very high surface resistance. Perfect for spoons and pliers.
Symbioplex	PMMA/ABS	Unbreakable	Very high	Very good	130°	Material with methacrylate and ABS characteristics.
PETG	PETG	Unbreakable	Medium	Good	70°	Used specifically when an indestructible transparent material is needed.

INDICE ANALITICO

Index

CODICE CODE	PAG. PAGE	CODICE CODE	PAG. PAGE	CODICE CODE	PAG. PAGE	CODICE CODE	PAG. PAGE
AAP		AVAVCB32001	180	AVBNRGD133	173	AVDP000799	156
AAPFA060084	123	AVAVCB32501	180	AVC	159	AVDSCS0101	165
ACS		AVAVCB33001	180	AVCB3030XX	159	AVDSEC0105	165
ACSPLD0105	167	AVAVCB42001	180	AVCB4545XX	159	AVDSEC0107	165
ACSPLD0205	167	AVAVCB42501	180	AVCD5380XX	183	AVDSEC0101	165
ACSPLD0305	167	AVAVCB43001	180	AVCP3T12	133	AVDSIX0112	164
ACSPLS0105	167	AVAVCB61	184	AVCPH080	133	AVDSMG0105	164
ACSPLS0205	167	AVAVGL0L31	181	AVCPH115	133	AVDSMG0205	164
ACSPLS0305	167	AVAVGL0M31	181	AVCPH180	133	AVDSMG0305	164
ACSPLS0405	167	AVAVGL0S31	181	AVCPH215	152	AVDSRSB103	184
ACSPSD0105	167	AVAVGLXL31	181	AVCRBK0212	152	AVDSRSB106	184
ACSPSD0205	167	AVAVGLXS31	181	AVCRBKDG12	152	AVDSRSB107	184
ACSPSD0305	167	AVAVGS0L31	181	AVCS210102	151	AVDSRSB113	184
ACSPSD0405	167	AVAVGS0M31	181	AVCS210103	151	AVDSSB0102	184
ACS PSS0105	167	AVAVGS0S31	181	AVCS210105	151	AVE	
ACS PSS0205	167	AVAVGSXS31	181	AVCS210106	151	AVECCH0102	184
ACS PSS0305	167	AVAVHW4031	180	AVCS210107	151	AVECCH0103	184
ACS PSS0405	167	AVAVHW4531	180	AVCS210109	151	AVECCH0106	184
ACS PSS0505	167	AVAVMT1531	180	AVCS212102	151	AVECCH0107	184
ALB		AVAVMT2031	180	AVCS212103	151	AVECCH0305	184
ALBCC07501	185	AVAVMT2031	181	AVCS212105	151	AVECCH0306	184
ALBCC10001	185	AVAVPS0031	181	AVCS212106	151	AVECCH0405	184
ALBCC15001	185	AVAVSC0031	180	AVCS212107	151	AVECDP0101	262
ALBPB08001	185	AVAVSC0031	181	AVCS212109	151	AVECDP0102	262
ALBPB08010	185	AVAVSXBT	184	AVCS270102	151	AVECDP0103	262
ALBPB12001	185	AVAVSXWB	184	AVCS270103	151	AVECDP0104	262
ALBPB12002	185	AVB		AVCS270105	151	AVECDP0106	262
ALBPB12003	185	AVBACM5012	181	AVCS270106	151	AVECDP0107	262
ALBPB12004	185	AVBCA07507	185	AVCS270107	151	AVECDP0301	262
ALBPB12006	185	AVBCA10007	185	AVCS270109	151	AVECDP0302	262
ALBPB12007	185	AVBCA15007	185	AVCS272102	151	AVECDP0303	262
ATT		AVBCB07501	185	AVCS272103	151	AVECDP0304	262
ATTMUR	263	AVBCB10001	185	AVCS272105	151	AVECDP0305	262
AVA		AVBCB15001	185	AVCS272106	151	AVECDP0306	262
AVAB661208	182	AVBCG10112	182	AVCS272107	151	AVECDP0307	262
AVACSPS108	178	AVBCG10212	182	AVCS272109	151	AVECMT01	262
AVAFSP0108	182	AVBCG10312	182	AVCS5080XX	159	AVECRC01	262
AVAS12410508	176	AVBCG10412	182	AVCSJR0112	153	AVECRC02	262
AVAS12410708	176	AVBCG10512	182	AVCSMTY202	149	AVECRC03	262
AVASPGFA1308	178	AVBCG10612	182	AVCSMTY203	149	AVECRC0405	260
AVASPGFM1108	178	AVBCG10712	182	AVCSMTY205	149	AVECRC05	262
AVASPGFM1208	178	AVBCG10812	182	AVCSMTY206	149	AVECRT0108	258
AVASPGFM1308	178	AVBCG10912	182	AVCSMTY207	149	AVECRT0208	258
AVASTT3360	182	AVBCG11012	182	AVCSTY3302	149	AVECRT0308	258
AVAVBCC105	183	AVBCG11112	182	AVCSTY3303	149	AVECSBDS05	264
AVAVBCS101	183	AVBCG11212	182	AVCSTY3305	149	AVECSBLX05	260
AVAVBCS105	183	AVBCG11312	182	AVCSTY3306	149	AVECSBMC05	264
AVAVBP0108	183	AVBCG11412	182	AVCSTY3307	149	AVECSTFE01	255
AVAVCB02001	180	AVBCG11512	182	AVCTMI1505	144	AVECSTFE05	255
AVAVCB02501	180	AVBCG11612	182	AVCUB806	136	AVECSV0105	262
AVAVCB03001	180	AVBCG11712	182	AVCUB812	136	AVECSV0205	262
AVAVCB12001	180	AVBCG11812	182	AVD		AVECT105	258
AVAVCB12501	180	AVBCG11912	182	AVDP000199	155	AVECT10P01	255
AVAVCB13001	180	AVBCG12012	182	AVDP000299	155	AVECT10P05	255
AVAVCB22001	180	AVBGOXL PPL	157	AVDP000399	155	AVECT140	258
AVAVCB22501	180	AVBGOXXL PPL	157	AVDP000499	155	AVECT205	258
AVAVCB23001	180	AVBNRGD099	173	AVDP000699	156	AVECT240	258

CODICE CODE	PAG. PAGE	CODICE CODE	PAG. PAGE	CODICE CODE	PAG. PAGE	CODICE CODE	PAG. PAGE
AVECT310	258	AVSB640107	148	CGACBP0203	126	CGACBR5005	126
AVECT315	258	AVSB640109	148	CGACBP0205	126	CGACBR5006	126
AVECT5B15H01	256	AVSB640510	148	CGACBP0206	126	CGACBR5007	126
AVECT5B15H05	256	AVSB640608	148	CGACBP0207	126	CGACBR5009	126
AVECT5B17H01	256	AVSB640608	148	CGACBP0209	126	CGALPE0501	106
AVECT5B17H05	256	AVSB640608	148	CGACBP0301	126	CGB	
AVECT5B22H01	256	AVSB640608	148	CGACBP0303	126	CGBITBXX08	105
AVECT5B22H05	256	AVSB640608	148	CGACBP0305	126	CGC	
AVECT5B22V01	256	AVSB640608	148	CGACBP0306	126	CGCAAPR012	121
AVECT5B22V05	256	AVSB640608	148	CGACBP0307	126	CGCAAPR112	121
AVECT5B24H01	256	AVSB640608	148	CGACBP0309	126	CGCACBW020	121
AVECT5B24H05	256	AVSB640608	148	CGACBP5001	126	CGCADB84	124
AVECT5B24V01	256	AVSB640608	148	CGACBP5003	126	CGCAE20312	119
AVECT5B24V05	256	AVSB640608	148	CGACBP5005	126	CGCAE30512	119
AVECT5B27H01	256	AVSB640608	148	CGACBP5006	126	CGCAED2012	120
AVECT5B27H05	256	AVSB640608	148	CGACBP5007	126	CGCAED2112	120
AVECT5B32H01	256	AVSB640608	148	CGACBP5009	126	CGCAEPR012	121
AVECT5B32H05	256	AVSB640608	148	CGACBR0101	126	CGCAEPR112	121
AVECT5P1505	255	AVSB640608	148	CGACBR0103	126	CGCAPEB108	119
AVECT5Q01	254	AVSB640608	148	CGACBR0105	126	CGCAPEB208	119
AVECT5Q05	254	AVSB640608	148	CGACBR0106	126	CGCAPSB108	119
AVECT5T01	254	AVSB640608	148	CGACBR0107	126	CGCAPSB208	119
AVECT5T05	254	AVSB640608	148	CGACBR0109	126	CGCAR20312	119
AVECVP0105	259	AVSB640608	148	CGACBR0101	126	CGCAR30512	119
AVECVP0205	259	AVSB640608	148	CGACBR0103	126	CGCARD2012	120
AVECVP0305	259	AVSB640608	148	CGACBR0105	126	CGCARD2112	120
AVECVP04	258	AVSB640608	148	CGACBR0106	126	CGCARE2012	120
AVF		AVSB640608	148	CGACBR0107	126	CGCARE2112	120
AVFGPRSBXX	159	AVSB640608	148	CGACBR0109	126	CGCARI0012	123
AVM		AVSB640608	148	CGACBR0201	126	CGCARM2012	120
AVMIRN86CBXX	144	AVSB640608	148	CGACBR0203	126	CGCARM2012	120
AVMIRN86FBXX	144	AVSB640608	148	CGACBR0205	126	CGCAYB0012	124
AVMIRN86PBXX	144	AVSB640608	148	CGACBR0206	126	CGCAYD4012	124
AVMPLCFE	181	AVSB640608	148	CGACBR0207	126	CGCAYM0012	124
AVP		AVSB640608	148	CGACBR0209	126	CGCAYM3012	124
AVPFMI6005	144	AVSB640608	148	CGACBR0201	126	CGCAYM4012	124
AVPL0015XX	134	AVSB640608	148	CGACBR0203	126	CGE	
AVPL0035XX	134	AVSB640608	148	CGACBR0205	126	CGEBA3VR08	101
AVPL0060XX	135	AVSB640608	148	CGACBR0206	126	CGEBA4VH08	101
AVPL0062XX	134	AVSB640608	148	CGACBR0207	126	CGEBA4VR08	101
AVPL0062XX	135	AVSB640608	148	CGACBR0209	126	CGEBA5VH08	101
AVPL0081XX	135	AVSB640608	148	CGACBR0301	126	CGEBA5VR08	101
AVPL0082XX	134	AVSB640608	148	CGACBR0303	126	CGEBA6VR08	101
AVPL0083XX	135	AVSB640608	148	CGACBR0305	126	CGECA30FHD	115
AVPL0120XX	134	AVSB640608	148	CGACBR0306	126	CGECA30FVD	115
AVPL0122XX	134	AVSB640608	148	CGACBR0307	126	CGECA3NVHD	115
AVPL050XX	134	AVSB640608	148	CGACBR0309	126	CGECA3NVVD	115
AVPL080XX	134	AVSB640608	148	CGACBR0301	126	CGECA40FHD	115
AVPL8060W1	137	AVSB640608	148	CGACBR0303	126	CGECA40FVD	115
AVPL8060W2	137	AVSB640608	148	CGACBR0305	126	CGECA4NVHD	115
AVPL8060W3	137	AVSB640608	148	CGACBR0306	126	CGECA4NVVD	115
AVPL8060W4	137	AVSB640608	148	CGACBR0307	126	CGECA50FHD	115
AVPLMI8005	144	AVSB640608	148	CGACBR0309	126	CGECA50FVD	115
AVPRBN13AD	173	AVSB640608	148	CGACBR5001	126	CGECA5NVHD	115
AVPRBN13MG	173	AVSB640608	148	CGACBR5003	126	CGECA5NVVD	115
AVR		AVSB640608	148	CGACBR5005	126	CGF	
AVRP050617	182	AVSB640608	148	CGACBR5006	126	CGFITFX08	105
AVS		AVSB640608	148	CGACBR5007	126	CGP	
AVSB640102	148	AVSB640608	148	CGACBR5009	126	CGPS000908	111
AVSB640103	148	AVSB640608	148	CGACBR5001	126	CGPS001008	111
AVSB640106	148	AVSB640608	148	CGACBR5003	126	CGPS004108	111

CODICE CODE	PAG. PAGE	CODICE CODE	PAG. PAGE	CODICE CODE	PAG. PAGE	CODICE CODE	PAG. PAGE
CGPS004108	155	CPAA000308	116	CPAAAIIV05	85	CPAAIN0705	94
CGPS004108	155	CPAA000708	116	CPAAAIC601	86	CPAAMU64	61
CGPS004108	155	CPAA001708	117	CPAAAIC605	86	CPAAMU6401	94
CGPS004108	155	CPAA007001	117	CPAAAIC701	86	CPAAMU6405	94
CGPS004108	156	CPAA0100012	73	CPAAAIC705	86	CPAAPM0108	116
CGPSABH508	101	CPAA0100012	73	CPAAAICL01	85	CPAAPSAV05	89
CGPSABH608	101	CPAA0100012	74	CPAAAICL05	85	CPAAPSAV08	89
CGPSABV508	101	CPAA0100012	74	CPAAAM00505	88	CPAAPZ0105	89
CGPSABV608	101	CPAA0100012	75	CPAAAM01005	88	CPAAPZ0205	90
CGPSAH0408	101	CPAA0100012	75	CPAAAM01505	88	CPAAPZC105	90
CGPSAH0508	101	CPAA010012	73	CPAAAPAP01	86	CPAAPZC205	91
CGPSAH0608	101	CPAA010012	73	CPAAAPAP05	86	CPAAPZF105	90
CGPSAV0408	101	CPAA010012	74	CPAAAPAV01	86	CPAAPZF205	90
CGPSAV0508	101	CPAA010012	74	CPAAAPAV05	86	CPAAPZM105	90
CGPSAV0608	101	CPAA010012	75	CPAAAPC601	86	CPAAPZM205	90
CGPSDFBX99	107	CPAA010012	75	CPAAAPC605	86	CPAAPZP105	90
CGPSDFMXX99	107	CPAA010012	129	CPAAAPC701	86	CPAAPZP205	90
CGPSEEBX99	107	CPAA015012	73	CPAAAPC705	86	CPAAPZV105	90
CGPSEEMX99	107	CPAA015012	73	CPAAAPCL01	86	CPAAPZV205	90
CGPSEEXX99	106	CPAA015012	74	CPAAAPCL05	86	CPAAQ60501	93
CGPSGL0108	108	CPAA015012	74	CPAAAT0101	87	CPAAQ60505	93
CGPSHS0401	112	CPAA015012	75	CPAAAT0105	87	CPAAQ60508	93
CGPSIEXX99	106	CPAA015012	75	CPAAAT0208	87	CPAAQ61001	93
CGPSLRCV09	77	CPAA015012	129	CPAAB05012	118	CPAAQ61005	93
CGPSLRFT02	77	CPAA030012	73	CPAAB10012	118	CPAAQ61008	93
CGPSLRLM06	77	CPAA030012	73	CPAABS0101	94	CPAAQ61501	93
CGPSLRUM03	77	CPAA030012	74	CPAACF3012	118	CPAAQ61505	93
CGPSMFA308	101	CPAA030012	74	CPAACF5012	118	CPAAQ61508	93
CGPSMFA408	101	CPAA030012	75	CPAACL0101	94	CPAAQ70501	93
CGPSMHA308	101	CPAA030012	75	CPAACL0105	94	CPAAQ70505	93
CGPSMHA408	101	CPAA030012	129	CPAACL0201	94	CPAAQ70508	93
CGPSPB0101	112	CPAA050012	73	CPAACL0205	94	CPAAQ71001	93
CGPSST0199	109	CPAA050012	73	CPAACLC101	88	CPAAQ71005	93
CGPSST0299	109	CPAA050012	74	CPAACLC101	111	CPAAQ71008	93
CGPSST0399	110	CPAA050012	74	CPAACLC201	112	CPAAQ71501	93
CGPSST0499	110	CPAA050012	75	CPAACR3005	127	CPAAQ71505	93
CGPSST0599	110	CPAA050012	75	CPAACS3012	118	CPAAQ71508	93
CGPSTB0208	104	CPAA050012	129	CPAACS5012	118	CPAAQC0501	92
CGPSTB0308	104	CPAA070012	73	CPAADHOT08	94	CPAAQC0505	92
CGPSTB0408	104	CPAA070012	73	CPAAEF3001	118	CPAAQC0508	92
CGPSTB0508	104	CPAA070012	74	CPAAEF5001	118	CPAAQC1001	92
CGPSTB0608	104	CPAA070012	74	CPAAES3001	118	CPAAQC1005	92
CGPSTB1008	104	CPAA070012	75	CPAAES5001	118	CPAAQC1008	92
CGPSTF0108	104	CPAA070012	75	CPAAFF3022	118	CPAAQC1501	92
CGPSTF0208	104	CPAA070012	129	CPAAFF5022	118	CPAAQC1505	92
CGPSTF0308	104	CPAA070B01	117	CPAAFF7522	118	CPAAQC1508	92
CGPSTF0408	104	CPAA100012	129	CPAAFS3022	118	CPAAQE0501	92
CGPSTF0508	104	CPAA174T01	116	CPAAFS5022	118	CPAAQE0505	92
CGPSTF0608	104	CPAAAG0101	85	CPAAFS7522	118	CPAAQE0508	92
CGPSWD0208	108	CPAAAG0105	85	CPAAHHS112	129	CPAAQE1001	92
CGPSWN8508	108	CPAAAG0401	85	CPAAHM0112	129	CPAAQE1005	92
CMS		CPAAAG0405	85	CPAAHP0008	117	CPAAQE1008	92
CMSEGTB108	112	CPAAAG0501	85	CPAAHS0212	129	CPAAQE1501	92
CP2		CPAAAG0505	85	CPAAHS0312	129	CPAAQE1505	92
CP27PIA12	93	CPAAAGC601	87	CPAAIG0101	93	CPAAQE1508	92
CP28PIA12	93	CPAAAGC605	87	CPAAIG0105	93	CPAAQM0501	93
CP29ATT01	93	CPAAAGC701	87	CPAAIG0101	94	CPAAQM0505	93
CP29ATT05	93	CPAAAGC705	87	CPAAIG0105	94	CPAAQM0508	93
CPA		CPAAAIAP01	85	CPAAIN0601	94	CPAAQM1001	93
CPAA000108	116	CPAAAIAP05	85	CPAAIN0605	94	CPAAQM1005	93
CPAA000208	116	CPAAAIIV01	85	CPAAIN0701	94	CPAAQM1008	93

CODICE CODE	PAG. PAGE	CODICE CODE	PAG. PAGE	CODICE CODE	PAG. PAGE	CODICE CODE	PAG. PAGE
CPAAQM1501	93	CPAASA1005	89	CPASCDKC05	60	CPLAF53005	72
CPAAQM1505	93	CPAASA1501	89	CPASCDKTCL	60	CPLAF53105	72
CPAAQM1508	93	CPAASA1505	89	CPASCDRB01	60	CPLAF60105	72
CPAAQP0501	93	CPAASC0501	89	CPASCDRB05	60	CPLAF60605	72
CPAAQP0505	93	CPAASC0505	89	CPASCDRB99	60	CPLAF63005	72
CPAAQP0508	93	CPAASC1001	89	CPC		CPLAF63105	72
CPAAQP1001	93	CPAASC1005	89	CPCRA30001	114	CPLAF6VS05	17
CPAAQP1005	93	CPAASC1501	89	CPCRA30002	114	CPLAFF0105	73
CPAAQP1008	93	CPAASC1505	89	CPCRA30003	114	CPLAFF3005	73
CPAAQP1501	93	CPAASE0501	89	CPCRA30004	114	CPLAFF3105	73
CPAAQP1505	93	CPAASE0505	89	CPCRA30005	114	CPLAFV0105	74
CPAAQP1508	93	CPAASE1001	89	CPCRA30006	114	CPLAFV3005	74
CPAAQS0501	93	CPAASE1005	89	CPCRA30007	114	CPLAFV3105	74
CPAAQS0505	93	CPAASE1501	89	CPCRA30008	114	CPLALR0102	76
CPAAQS0508	93	CPAASE1505	89	CPCRA40001	114	CPLALR0202	76
CPAAQS1001	93	CPAASL6401	94	CPCRA40002	114	CPLALR0308	76
CPAAQS1005	93	CPAASN0105	91	CPCRA40003	114	CPLALR0402	76
CPAAQS1008	93	CPAASN0108	91	CPCRA40004	114	CPLALR0505	76
CPAAQS1501	93	CPAASN0505	91	CPCRA40005	114	CPLAMFA305	68
CPAAQS1505	93	CPAASN0508	91	CPCRA40006	114	CPLAOF0105	75
CPAAQS1508	93	CPAASN1005	91	CPCRA40007	114	CPLAOF0605	75
CPAAQT0101	92	CPAASN1008	91	CPCRA40008	114	CPLAOF3005	75
CPAAQT0105	92	CPAASQ3005	127	CPCRA50001	114	CPLAOF3105	75
CPAAQT0108	92	CPAAST0501	89	CPCRA50002	114	CPLAOFH405	68
CPAAQT0501	92	CPAAST0505	89	CPCRA50003	114	CPLAOFV405	68
CPAAQT0505	92	CPAAST1001	89	CPCRA50004	114	CPLAOX0105	75
CPAAQT0508	92	CPAAST1005	89	CPCRA50005	114	CPLAOX3005	75
CPAAQT1001	92	CPAAST1501	89	CPCRA50006	114	CPLAOX3105	75
CPAAQT1005	92	CPAAST1505	89	CPCRA50007	114	CPLAP20101	69
CPAAQT1008	92	CPAASV0101	94	CPCRA50008	114	CPLAP30101	69
CPAAQT1501	92	CPAASV0105	94	CPCRA60001	114	CPLAP40101	69
CPAAQT1505	92	CPAASVCL01	94	CPCRA60002	114	CPLAPL2002	70
CPAAQT1508	92	CPAASVCL05	94	CPCRA60003	114	CPLAPL2003	70
CPAAQW0501	92	CPAAT00101	117	CPCRA60004	114	CPLAPL2004	70
CPAAQW0505	92	CPAAT00208	117	CPCRA60005	114	CPLAPL2005	70
CPPAAQW0508	92	CPAAT00308	117	CPCRA60006	114	CPLAPL2006	70
CPAAQW1001	92	CPAAT00308	117	CPCRA60007	114	CPLAPL2007	70
CPAAQW1005	92	CPAAT0501	88	CPCRA60008	114	CPLAPP2005	70
CPAAQW1008	92	CPAAT0505	88	CPI		CPLAWD0101	70
CPAAQW1501	92	CPAAT1001	88	CPIPCF0001	77	CPLAXF0105	67
CPAAQW1505	92	CPAAT1005	88	CPIPCF0005	77	CPLAXF0605	73
CPAAQW1508	92	CPAAT1501	88	CPIPCF0101	77	CPLAXF3005	73
CPAARB0101	128	CPAAT1505	88	CPIPCF0105	77	CPLAXF3105	73
CPAARL0101	128	CPAATJ0801	88	CPIPCF0201	77	CPLAXV0105	73
CPAART0101	128	CPAATJ0805	88	CPL		CPLAXV0605	74
CPAAS02108	116	CPAATN0101	88	CPLA010105	67	CPLAXV3005	74
CPAAS60501	89	CPAATN0105	88	CPLA110101	67	CPLAXV3105	74
CPAAS60505	89	CPAATNCL01	88	CPLA120102	67	CPLBFX73X140	74
CPAAS61001	89	CPAATNCL05	88	CPLA1F0605	70	CPLMNF000005	83
CPAAS61005	89	CPAATS0308	117	CPLA1F2005	70	CPLMNF000105	82
CPAAS61501	89	CPAATS0408	117	CPLA1F3205	70	CPLMNF000205	82
CPAAS61505	89	CPAATS0508	117	CPLA2F0605	71	CPLPNFX000005	82
CPAAS70501	89	CPAATS0608	117	CPLA2F2005	71	CPLPNFX00105	81
CPAAS70505	89	CPAATS0708	117	CPLA2F3205	71	CPLPNFX00205	81
CPAAS71001	89	CPAAVWC108	116	CPLA3F0605	71	CPLPNFX00305	81
CPAAS71005	89	CPAAYQ3005	127	CPLA3F2005	71	CPLPNFX00405	81
CPAAS71501	89	CPACO0308	128	CPLA3F3205	71	CPLPNFX00505	81
CPAAS71505	89	CPACO0408	128	CPLA50101	69	CPLTNFX000005	81
CPAASA0501	89	CPACV0308	128	CPLABFA305	68	CPLTNFX00105	79
CPAASA0505	89	CPACV0408	128	CPLAF50105	72	CPLTNFX00205	79
CPAASA1001	89	CPASCDKC01	60	CPLAF50605	72	CPLTNFX00305	79

CODICE CODE	PAG. PAGE	CODICE CODE	PAG. PAGE	CODICE CODE	PAG. PAGE	CODICE CODE	PAG. PAGE
CPLTNFX00405	79	CPPRBC0P3906	97	CPSPJD0201	257	ETBT060090NP01	213
CPLTNFX00505	79	CPPRBC0P3907	97	CPSPJD0205	257	ETBT060150NP01	213
CPLTNFX00605	79	CPPRCEB41001	95	CPSPJD0301	257	ETBT061055NP01	218
CPLTNFX00705	79	CPPRCEB41008	95	CPSPJD0305	257	ETBT062030NP01	213
CPLTNFX00805	79	CPPRCEB41301	95	CPSPJD0401	257	ETBT062090NP01	213
CPLTNFX00905	79	CPPRCEB41308	95	CPSPJD0405	257	ETBT062150NP01	213
CPLTNFX01005	79	CPPRCEG31001	96	CPSPJK2002	63	ETP	
CPLTNFX01105	79	CPPRCEG31008	96	CPSPJK2003	63	ETPR2112CP01	231
CPLTNFX01205	80	CPPRCEG31301	96	CPSPJK2005	63	ETPR2112CP03	231
CPLTNFX01305	80	CPPRCEG31308	96	CPSPJK2006	63	ETPR2112CP06	231
CPLTNFX01405	80	CPPRCEG41001	96	CPSPJK2007	63	ETPR2112CP07	231
CPLTNFX01505	80	CPPRCEG41008	96	CPSPJK3002	63	ETPR2112CP09	231
CPLTNFX01605	80	CPPRCEG41301	96	CPSPJK3006	63	ETPR2112CP13	231
CPLTNFX01705	80	CPPRCEG41308	96	CPSPJK3102	63	ETPR2112CP14	231
CPP		CPPRHEM10001	97	CPSPJK3106	63	ETPR2112CR01	231
CPPCTBC	61	CPPRHEM10008	97	CPSPJK3206	63	ETPR2112CR03	231
CPPNMG33X130	82	CPPRHEM11301	97	CPSPLR01	63	ETPR2112CR06	231
CPPR03210101	96	CPPRHEM11308	97	CPSPLR01	63	ETPR2112CR07	231
CPPR03210108	96	CPPRPET41001	96	CPSPMT2008	64	ETPR2112CR09	231
CPPR03218008	144	CPPRPET41008	96	CPSPMT30	64	ETPR2112CR13	231
CPPR04126001	97	CPPRPET41301	96	CPSPMT31	64	ETPR2112CR14	231
CPPR04126008	97	CPPRPET41308	96	CPSPMT34	64	ETPR2112CS01	231
CPPR04126501	97	CPPRSGM41301	172	CPSPSB2002	63	ETPR2112CS03	231
CPPR04126508	97	CPPRSGT41301	172	CPSPSB2003	63	ETPR2112CS06	231
CPPR04127501	97	CPPRSY101001	96	CPSPSB2005	63	ETPR2112CS07	231
CPPR04127508	97	CPPRSY101008	96	CPSPSB2006	63	ETPR2112CS09	231
CPPR04601001	96	CPPRSY101301	96	CPSPSB2007	63	ETPR2112CS13	231
CPPR04601008	96	CPPRSY101308	96	CPSPSB3006	63	ETPR2112CS14	231
CPPR04601301	96	CPPRSY102001	96	CPSPSB3106	63	ETPR2112FP50	231
CPPR04601308	96	CPPRSY102008	96	CPSPSB3306	63	ETPR2112FP51	231
CPPR102S1001	95	CPPRSY102301	96	CPSPTA2008	64	ETPR2112FP52	231
CPPR102S1008	95	CPPRSY102308	96	CPSPTA30	64	ETPR2112FP53	231
CPPR102S1301	95	CPPRTA260501	96	CPSPTA31	64	ETPR2112FP54	231
CPPR102S1308	95	CPPRTA260508	96	CPSPTA34	64	ETPR2112FR50	231
CPPR111S1001	96	CPPRTA260801	96	CPSPVF3508	65	ETPR2112FR51	231
CPPR111S1008	96	CPPRTA260808	96	CPSPVF4508	65	ETPR2112FR52	231
CPPR111S11301	96	CPPRTGM41001	95	CPSPVF5508	65	ETPR2112FR53	231
CPPR111S11308	96	CPPRTGM41008	95	DTA		ETPR2112FR54	231
CPPRADH31001	95	CPPRTGM41301	95	DTAMAN00	244	ETPR2112FS50	231
CPPRADH31008	95	CPPRTGM41308	95	DTU		ETPR2112FS51	231
CPPRADH31301	95	CPPRTR310001	97	DTUCON00	244,246	ETPR2112FS52	231
CPPRADH31308	95	CPPRTR310008	97	DTUELE00	244,246	ETPR2112FS53	231
CPPRADH41001	95	CPPRTR311301	97	DVA		ETPR2112FS54	231
CPPRADH41005	95	CPPRTR311308	97	DVA2050	244	ETPR2112TP01	231
CPPRADH41301	95	CPPRTRC11001	97	DVR		ETPR2112TR01	231
CPPRADH41305	95	CPPRTRC11008	97	DVR0282	246	ETPR2112TS01	231
CPPRALG31001	96	CPPRTRC11301	97	EAR		ETPR2216CP01	231
CPPRALG31008	96	CPPRTRC11308	97	EART58747601	218	ETPR2216CP03	231
CPPRALG31301	96	CPPRTVB41001	96	ETB		ETPR2216CP06	231
CPPRALG31308	96	CPPRTVB41008	96	ETBT040072NP01	218	ETPR2216CP07	231
CPPRANG07401	97	CPPRTVB41301	96	ETBT047061NP01	218	ETPR2216CP09	231
CPPRANG07408	97	CPPRTVB41308	96	ETBT047081NP01	218	ETPR2216CP13	231
CPPRANG12401	97	CPS		ETBT057030NP01	213	ETPR2216CP14	231
CPPRANG12408	97	CPSCMGC300	57	ETBT057235NP01	213	ETPR2216CR01	231
CPPRBCOC38	97	CPSCPR00	58	ETBT058043NP01	218	ETPR2216CR03	231
CPPRBCOP2602	97	CPSPJBLD02	63	ETBT058053NP01	218	ETPR2216CR06	231
CPPRBCOP2603	97	CPSPJBLD06	63	ETBT058060NP01	218	ETPR2216CR07	231
CPPRBCOP2606	97	CPSPJBLD02	63	ETBT058074NP01	218	ETPR2216CR09	231
CPPRBCOP2607	97	CPSPJBLD06	63	ETBT060030NP01	213	ETPR2216CR13	231
CPPRBCOP3902	97	CPSPJD0101	257	ETBT060045NP01	218	ETPR2216CR14	231
CPPRBCOP3903	97	CPSPJD0105	257	ETBT060075NP01	218	ETPR2216CS01	231

CODICE CODE	PAG. PAGE	CODICE CODE	PAG. PAGE	CODICE CODE	PAG. PAGE	CODICE CODE	PAG. PAGE
ETPR2216CS03	231	ETPR2616CP09	231	ETPR2619FS53	232	ETPR3219CS07	232
ETPR2216CS06	231	ETPR2616CP13	231	ETPR2619FS54	232	ETPR3219CS09	232
ETPR2216CS07	231	ETPR2616CP14	231	ETPR2619HR	232	ETPR3219CS13	232
ETPR2216CS09	231	ETPR2616CR01	231	ETPR2619HS	232	ETPR3219CS14	232
ETPR2216CS13	231	ETPR2616CR03	231	ETPR2928CP01	232	ETPR3219FP50	232
ETPR2216CS14	231	ETPR2616CR06	231	ETPR2928CP03	232	ETPR3219FP51	232
ETPR2216FP50	231	ETPR2616CR07	231	ETPR2928CP06	232	ETPR3219FP52	232
ETPR2216FP51	231	ETPR2616CR09	231	ETPR2928CP07	232	ETPR3219FP53	232
ETPR2216FP52	231	ETPR2616CR13	231	ETPR2928CP09	232	ETPR3219FP54	232
ETPR2216FP53	231	ETPR2616CR14	231	ETPR2928CP13	232	ETPR3219FR50	232
ETPR2216FP54	231	ETPR2616CS01	231	ETPR2928CP14	232	ETPR3219FR51	232
ETPR2216FR50	231	ETPR2616CS03	231	ETPR2928CR01	232	ETPR3219FR52	232
ETPR2216FR51	231	ETPR2616CS06	231	ETPR2928CR03	232	ETPR3219FR53	232
ETPR2216FR52	231	ETPR2616CS07	231	ETPR2928CR06	232	ETPR3219FR54	232
ETPR2216FR53	231	ETPR2616CS09	231	ETPR2928CR07	232	ETPR3219FS50	232
ETPR2216FR54	231	ETPR2616CS13	231	ETPR2928CR09	232	ETPR3219FS51	232
ETPR2216FS50	231	ETPR2616CS14	231	ETPR2928CR13	232	ETPR3219FS52	232
ETPR2216FS51	231	ETPR2616FP50	231	ETPR2928CR14	232	ETPR3219FS53	232
ETPR2216FS52	231	ETPR2616FP51	231	ETPR2928CS01	232	ETPR3219FS54	232
ETPR2216FS53	231	ETPR2616FP52	231	ETPR2928CS03	232	ETPR3719CP01	233
ETPR2216FS54	231	ETPR2616FP53	231	ETPR2928CS06	232	ETPR3719CP03	233
ETPR2612CP01	231	ETPR2616FP54	231	ETPR2928CS07	232	ETPR3719CP06	233
ETPR2612CP03	231	ETPR2616FR50	231	ETPR2928CS09	232	ETPR3719CP07	233
ETPR2612CP06	231	ETPR2616FR51	231	ETPR2928CS13	232	ETPR3719CP09	233
ETPR2612CP07	231	ETPR2616FR52	231	ETPR2928CS14	232	ETPR3719CP13	233
ETPR2612CP09	231	ETPR2616FR53	231	ETPR2928FP50	232	ETPR3719CP14	233
ETPR2612CP13	231	ETPR2616FR54	231	ETPR2928FP51	232	ETPR3719CR01	233
ETPR2612CP14	231	ETPR2616FS50	231	ETPR2928FP52	232	ETPR3719CR03	233
ETPR2612CR01	231	ETPR2616FS51	231	ETPR2928FP53	232	ETPR3719CR06	233
ETPR2612CR03	231	ETPR2616FS52	231	ETPR2928FP54	232	ETPR3719CR07	233
ETPR2612CR06	231	ETPR2616FS53	231	ETPR2928FR50	232	ETPR3719CR09	233
ETPR2612CR07	231	ETPR2616FS54	231	ETPR2928FR51	232	ETPR3719CR13	233
ETPR2612CR09	231	ETPR2619CP01	232	ETPR2928FR52	232	ETPR3719CR14	233
ETPR2612CR13	231	ETPR2619CP03	232	ETPR2928FR53	232	ETPR3719CR01	233
ETPR2612CR14	231	ETPR2619CP06	232	ETPR2928FR54	232	ETPR3719CR03	233
ETPR2612CS01	231	ETPR2619CP07	232	ETPR2928FS50	232	ETPR3719CR06	233
ETPR2612CS03	231	ETPR2619CP09	232	ETPR2928FS51	232	ETPR3719CR07	233
ETPR2612CS06	231	ETPR2619CP13	232	ETPR2928FS52	232	ETPR3719CR09	233
ETPR2612CS07	231	ETPR2619CP14	232	ETPR2928FS53	232	ETPR3719CR13	233
ETPR2612CS09	231	ETPR2619CR01	232	ETPR2928FS54	232	ETPR3719CR14	233
ETPR2612CS13	231	ETPR2619CR03	232	ETPR2928HP	232	ETPR3719CS01	233
ETPR2612CS14	231	ETPR2619CR06	232	ETPR2928HP	232	ETPR3719CS03	233
ETPR2612FP50	231	ETPR2619CR07	232	ETPR2928HR	232	ETPR3719CS06	233
ETPR2612FP51	231	ETPR2619CR09	232	ETPR2928HS	232	ETPR3719CS07	233
ETPR2612FP52	231	ETPR2619CR13	232	ETPR3219CP01	232	ETPR3719CS09	233
ETPR2612FP53	231	ETPR2619CR14	232	ETPR3219CP03	232	ETPR3719CS13	233
ETPR2612FP54	231	ETPR2619CS01	232	ETPR3219CP06	232	ETPR3719CS14	233
ETPR2612FR50	231	ETPR2619CS03	232	ETPR3219CP07	232	ETPR3719FP50	233
ETPR2612FR51	231	ETPR2619CS06	232	ETPR3219CP09	232	ETPR3719FP51	233
ETPR2612FR52	231	ETPR2619CS07	232	ETPR3219CP13	232	ETPR3719FP52	233
ETPR2612FR53	231	ETPR2619CS09	232	ETPR3219CP14	232	ETPR3719FP53	233
ETPR2612FR54	231	ETPR2619CS13	232	ETPR3219CR01	232	ETPR3719FP54	233
ETPR2612FS50	231	ETPR2619CS14	232	ETPR3219CR03	232	ETPR3719FR50	233
ETPR2612FS51	231	ETPR2619FP50	232	ETPR3219CR06	232	ETPR3719FR51	233
ETPR2612FS52	231	ETPR2619FP51	232	ETPR3219CR07	232	ETPR3719FR52	233
ETPR2612FS53	231	ETPR2619FP52	232	ETPR3219CR09	232	ETPR3719FR53	233
ETPR2612FS54	231	ETPR2619FP53	232	ETPR3219CR13	232	ETPR3719FR54	233
ETPR2616CP01	231	ETPR2619FP54	232	ETPR3219CR14	232	ETPR3719FS50	233
ETPR2616CP03	231	ETPR2619FR50	232	ETPR3219CS01	232	ETPR3719FS51	233
ETPR2616CP06	231	ETPR2619FR51	232	ETPR3219CS03	232	ETPR3719FS52	233
ETPR2616CP07	231	ETPR2619FR52	232	ETPR3219CS06	232	ETPR3719FS53	233

CODICE CODE	PAG. PAGE	CODICE CODE	PAG. PAGE	CODICE CODE	PAG. PAGE	CODICE CODE	PAG. PAGE
ETPR3719FS54	233	ETPS2212FR52	233	ETPS2612CS07	234	ETPS2612CS14	234
ETPR3728CP01	233	ETPS2212FR53	233	ETPS2612CS09	234	ETPS2612FP50	234
ETPR3728CP03	233	ETPS2212FR54	233	ETPS2612CS13	234	ETPS2612FP51	234
ETPR3728CP06	233	ETPS2212FS50	233	ETPS2612CS14	234	ETPS2612FP52	234
ETPR3728CP07	233	ETPS2212FS51	233	ETPS2612FP50	234	ETPS2612FP53	234
ETPR3728CP09	233	ETPS2212FS52	233	ETPS2612FP51	234	ETPS2612FP54	234
ETPR3728CP13	233	ETPS2212FS53	233	ETPS2612FP52	234	ETPS2612FR50	234
ETPR3728CP14	233	ETPS2212FS54	233	ETPS2612FP53	234	ETPS2612FR51	234
ETPR3728CS01	233	ETPS2216CP01	234	ETPS2612FP54	234	ETPS2612FR52	234
ETPR3728CS03	233	ETPS2216CP03	234	ETPS2612FR50	234	ETPS2612FR53	234
ETPR3728CS06	233	ETPS2216CP06	234	ETPS2612FR51	234	ETPS2612FR54	234
ETPR3728CS07	233	ETPS2216CP07	234	ETPS2612FR52	234	ETPS2612FS50	234
ETPR3728CS09	233	ETPS2216CP09	234	ETPS2612FR53	234	ETPS2612FS51	234
ETPR3728CS13	233	ETPS2216CP13	234	ETPS2612FR54	234	ETPS2612FS52	234
ETPR3728CS14	233	ETPS2216CP14	234	ETPS2612FS50	234	ETPS2612FS53	234
ETPR3728FP50	233	ETPS2216CR01	234	ETPS2612FS51	234	ETPS2612FS54	234
ETPR3728FP51	233	ETPS2216CR03	234	ETPS2612FS52	234	ETPS2616CP01	234
ETPR3728FP52	233	ETPS2216CR06	234	ETPS2612FS53	234	ETPS2616CP03	234
ETPR3728FP53	233	ETPS2216CR07	234	ETPS2612FS54	234	ETPS2616CP06	234
ETPR3728FP54	233	ETPS2216CR09	234	ETPS2616CP01	234	ETPS2616CP07	234
ETPR3728FR50	233	ETPS2216CR13	234	ETPS2616CP03	234	ETPS2616CP09	234
ETPR3728FR51	233	ETPS2216CR14	234	ETPS2616CP06	234	ETPS2616CP13	234
ETPR3728FR52	233	ETPS2216CS01	234	ETPS2616CP07	234	ETPS2616CP14	234
ETPR3728FR53	233	ETPS2216CS03	234	ETPS2616CP09	234	ETPS2616CR01	234
ETPR3728FR54	233	ETPS2216CS06	234	ETPS2616CP13	234	ETPS2616CR03	234
ETPR3728F550	233	ETPS2216CS07	234	ETPS2616CP14	234	ETPS2616CR06	234
ETPR3728F551	233	ETPS2216CS09	234	ETPS2616CR01	234	ETPS2616CR07	234
ETPR3728F552	233	ETPS2216CS13	234	ETPS2616CR03	234	ETPS2616CR09	234
ETPR3728F553	233	ETPS2216CS14	234	ETPS2616CR06	234	ETPS2616CR13	234
ETPR3728F554	233	ETPS2216FP50	234	ETPS2616CR07	234	ETPS2616CR14	234
ETPR3728HP	233	ETPS2216FP51	234	ETPS2616CR09	234	ETPS2616CS01	234
ETPR3728HR	233	ETPS2216FP52	234	ETPS2616CR13	234	ETPS2616CS03	234
ETPR3728HS	233	ETPS2216FP53	234	ETPS2616CR14	234	ETPS2616CS06	234
ETPS2212CP01	233	ETPS2216FP54	234	ETPS2616CS01	234	ETPS2616CS07	234
ETPS2212CP03	233	ETPS2216FR50	234	ETPS2616CS03	234	ETPS2616CS09	234
ETPS2212CP06	233	ETPS2216FR51	234	ETPS2616CS06	234	ETPS2616CS13	234
ETPS2212CP07	233	ETPS2216FR52	234	ETPS2616CS07	234	ETPS2616CS14	234
ETPS2212CP09	233	ETPS2216FR53	234	ETPS2616CS09	234	ETPS2616FP50	234
ETPS2212CP13	233	ETPS2216FR54	234	ETPS2616CS13	234	ETPS2616FP51	234
ETPS2212CP14	233	ETPS2216FS50	234	ETPS2616CS14	234	ETPS2616FP52	234
ETPS2212CR01	233	ETPS2216FS51	234	ETPS2616FP50	234	ETPS2616FP53	234
ETPS2212CR03	233	ETPS2216FS52	234	ETPS2616FP51	234	ETPS2616FP54	234
ETPS2212CR06	233	ETPS2216FS53	234	ETPS2616FP52	234	ETPS2616FR50	234
ETPS2212CR07	233	ETPS2216FS54	234	ETPS2616FP53	234	ETPS2616FR51	234
ETPS2212CR09	233	ETPS2612CP01	234	ETPS2616FP54	234	ETPS2616FR52	234
ETPS2212CR13	233	ETPS2612CP03	234	ETPS2616FR50	234	ETPS2616FR53	234
ETPS2212CR14	233	ETPS2612CP06	234	ETPS2616FR51	234	ETPS2616FR54	234
ETPS2212CS01	233	ETPS2612CP07	234	ETPS2616FR52	234	ETPS2616FS50	234
ETPS2212CS03	233	ETPS2612CP09	234	ETPS2616FR53	234	ETPS2616FS51	234
ETPS2212CS06	233	ETPS2612CP13	234	ETPS2616FR54	234	ETPS2616FS52	234
ETPS2212CS07	233	ETPS2612CP14	234	ETPS2616FS50	234	ETPS2616FS53	234
ETPS2212CS09	233	ETPS2612CR01	234	ETPS2616FS51	234	ETPS2616FS54	234
ETPS2212CS13	233	ETPS2612CR03	234	ETPS2616FS52	234	ETPS2618CP01	234
ETPS2212CS14	233	ETPS2612CR06	234	ETPS2616FS53	234	ETPS2618CP03	234
ETPS2212FP50	233	ETPS2612CR07	234	ETPS2616FS54	234	ETPS2618CP06	234
ETPS2212FP51	233	ETPS2612CR09	234	ETPS2618CP01	234	ETPS2618CP07	234
ETPS2212FP52	233	ETPS2612CR13	234	ETPS2618CP03	234	ETPS2618CP09	234
ETPS2212FP53	233	ETPS2612CR14	234	ETPS2618CP06	234	ETPS2618CP13	234
ETPS2212FP54	233	ETPS2612CS01	234	ETPS2618CP07	234	ETPS2618CP14	234
ETPS2212FR50	233	ETPS2612CS03	234	ETPS2618CP09	234	ETPS2618CR01	234
ETPS2212FR51	233	ETPS2612CS06	234	ETPS2618CP13	234	ETPS2618CR03	234

CODICE CODE	PAG. PAGE	CODICE CODE	PAG. PAGE	CODICE CODE	PAG. PAGE	CODICE CODE	PAG. PAGE
ETPS2618CR06	234	ETPS3219FS53	234	ETPVOV37CS14	235	LYU	
ETPS2618CR07	234	ETPS3219FS54	234	ETPVOV37FP50	235	LYU17ACP	245,249
ETPS2618CR09	234	ETPTD035CP01	235	ETPVOV37FP51	235	LYU3001BCP	245,249
ETPS2618CR13	234	ETPTD035CP03	235	ETPVOV37FP52	235	PAN	
ETPS2618CR14	234	ETPTD035CP06	235	ETPVOV37FP53	235	PANODDZ70LP	158
ETPS2618CS01	234	ETPTD035CP07	235	ETPVOV37FP54	235	PANODDZ90LP	158
ETPS2618CS03	234	ETPTD035CP09	235	ETPVOV37FR50	235	PANODOV70LP	158
ETPS2618CS06	234	ETPTD035CP13	235	ETPVOV37FR51	235	PANODOV90LP	158
ETPS2618CS07	234	ETPTD035CP14	235	ETPVOV37FR52	235	PEP	
ETPS2618CS09	234	ETPTD035CR01	235	ETPVOV37FR53	235	PEPROVL001	220
ETPS2618CS13	234	ETPTD035CR03	235	ETPVOV37FR54	235	PEPROVL002	220
ETPS2618CS14	234	ETPTD035CR06	235	ETPVOV37FS50	235	PEPRRCT001	221
ETPS2618FP50	234	ETPTD035CR07	235	ETPVOV37FS51	235	PEPRRCT002	221
ETPS2618FP51	234	ETPTD035CR09	235	ETPVOV37FS52	235	PEPRRCT003	221
ETPS2618FP52	234	ETPTD035CR13	235	ETPVOV37FS53	235	PEPRRCT004	221
ETPS2618FP53	234	ETPTD035CR14	235	ETPVOV37FS54	235	PEPRRCT005	221
ETPS2618FP54	234	ETPTD035CS01	235	ETPVOV37HP	235	PEPRRCT006	221
ETPS2618FR50	234	ETPTD035CS03	235	ETPVOV37HR	235	PEPRRCT007	221
ETPS2618FR51	234	ETPTD035CS06	235	ETPVOV37HS	235	PEPRRCT008	221
ETPS2618FR52	234	ETPTD035CS07	235	FC9		PEPRRCT009	221
ETPS2618FR53	234	ETPTD035CS09	235	FC95DIV/17	34	PEPRRND001	220
ETPS2618FR54	234	ETPTD035CS13	235	FC97DIV/17	34	PEPRRND002	220
ETPS2618FS50	234	ETPTD035CS14	235	FC98DIV/17	34	PEPRRND003	220
ETPS2618FS51	234	ETPTD035FP50	235	FX6		PEPRRND004	220
ETPS2618FS52	234	ETPTD035FP51	235	FX620	162	PEPRRND005	220
ETPS2618FS53	234	ETPTD035FP52	235	GCM		PEPRRND006	220
ETPS2618FS54	234	ETPTD035FP53	235	GCMPPH01	266	PEPRRND007	220
ETPS3219CP01	234	ETPTD035FP54	235	GCMPPH02	266	PEPRRND008	220
ETPS3219CP03	234	ETPTD035FR50	235	GCMPPH03	266	PEPRRND009	220
ETPS3219CP06	234	ETPTD035FR51	235	GCMPPH04	266	PEPRRND010	220
ETPS3219CP07	234	ETPTD035FR52	235	GCMPPH05	266	PEPRRND011	220
ETPS3219CP09	234	ETPTD035FR53	235	GCMPPH06	266	PEPRRND012	220
ETPS3219CP13	234	ETPTD035FR54	235	GCMPPH07	266	PEPRRND013	220
ETPS3219CP14	234	ETPTD035FS50	235	GCMPPH08	266	PEPRRND014	220
ETPS3219CR01	234	ETPTD035FS51	235	GCMPPH09	266	PEPRSQR001	221
ETPS3219CR03	234	ETPTD035FS52	235	GCT		PEPRSQR002	221
ETPS3219CR06	234	ETPTD035FS53	235	GCTLEC01	267	PEPRSQR003	221
ETPS3219CR07	234	ETPTD035FS54	235	GCTLEC02	267	PEPRSQR004	221
ETPS3219CR09	234	ETPTDH35HP	235	GCTLEC03	267	PEPRSQR005	221
ETPS3219CR13	234	ETPTH035HR	235	HTA		PFS	
ETPS3219CR14	234	ETPTH035HS	235	HTA2501SWB2	245	PFSS25021030WF	120
ETPS3219CS01	234	ETPVOV37CP01	235	HTA2701SWB2	245	PFSS25030042WF	120
ETPS3219CS03	234	ETPVOV37CP03	235	HTA3001SUPT1	245	PFSS25050070WF	120
ETPS3219CS06	234	ETPVOV37CP06	235	HTA3002SUPT2	245	PFSS25070100WF	120
ETPS3219CS07	234	ETPVOV37CP07	235	HTA3010BIGP	245	PFSS25100140WF	120
ETPS3219CS09	234	ETPVOV37CP09	235	HTA5001MIDP	245	PFSS70050070	120
ETPS3219CS13	234	ETPVOV37CP13	235	HTA5301BOTLMN	245	PFSS70070100	120
ETPS3219CS14	234	ETPVOV37CP14	235	HTA8029TE5	245	PFSS70100140	120
ETPS3219FP50	234	ETPVOV37CR01	235	HTA8029TE5BLK	245	PIU	
ETPS3219FP51	234	ETPVOV37CR03	235	HTR		PIUMA100X200	160
ETPS3219FP52	234	ETPVOV37CR06	235	HTR2501SWB2	249	PIUMA100X250	160
ETPS3219FP53	234	ETPVOV37CR07	235	HTR2701SWB2	249	PIUMA100X300	160
ETPS3219FP54	234	ETPVOV37CR09	235	HTR3005MIN52	248	PIUMA60X200	160
ETPS3219FR50	234	ETPVOV37CR13	235	HTR8001MIN46	248	PIUMA75X200	160
ETPS3219FR51	234	ETPVOV37CR14	235	HTR8010R50	248	PRB	
ETPS3219FR52	234	ETPVOV37CS01	235	HTR8010R50BLK	248	PRBZ06L105	228
ETPS3219FR53	234	ETPVOV37CS03	235	HTR8026TE	249	PRBZP1L3	229
ETPS3219FR54	234	ETPVOV37CS06	235	HTR8026TEBLK	249	PRBZP1L305	228
ETPS3219FS50	234	ETPVOV37CS07	235	HTR8029TE	249	PRBZP2L305	228
ETPS3219FS51	234	ETPVOV37CS09	235	HTR8029TEBLK	249	PRBZP3L305	228
ETPS3219FS52	234	ETPVOV37CS13	235	HTR8301BOTL5	249	PRD	

CODICE <i>CODE</i>	PAG. <i>PAGE</i>	CODICE <i>CODE</i>	PAG. <i>PAGE</i>	CODICE <i>CODE</i>	PAG. <i>PAGE</i>	CODICE <i>CODE</i>	PAG. <i>PAGE</i>
PRDEAL7005	224	PRSW16L212	226	PWFFPL0108	196	SEACFX1205	17
PRDEBC7005	224	PRSW17L212	226	PWFFPL0208	196	SEACTX5098	50
PRDEBT7005	224	PWB		PWFFPL0308	196	SEACYT1K98	50
PRDELD7010	224	PWBSPL0108	206	PWFFPL0408	196	SEC	
PRDMMD6005	224	PWBSPL0208	206	PWM		SECB102F31	48
PRE		PWBSPL0308	206	PWMEPL0134	203	SECB1036	50
PREV06L105	226	PWBSPL0408	206	PWMEPL0208	203	SECB1037	50
PREV10L105	226	PWBSPL0508	207	PWMEPL0308	203	SECB140032	21
PREV14L205	226	PWBSPL0608	207	PWMEPL0408	203	SECB140032	21
PREV27M210	227	PWBSPL0708	207	PWP		SECB144532	21
PREVA17310	227	PWBSPL0808	207	PWPGPL0199	194	SECB146532	21
PREVC77310	227	PWC		PWPGPL0299	194	SECB167331	47
PREVPRL110	227	PWCSPLO199	204	PWPGPL0399	194	SECB210032	21
PREVPTL110	227	PWCSPLO299	204	PWPGPL0499	194	SECB210032	21
PRG		PWCSPLO399	204	PWPGPL0599	195	SECB214532	21
PRGODEXT10	240	PWCSPLO499	204	PWPGPL0699	195	SECB216532	21
PRGODEXT20	240	PWCSPLO599	205	PWPGPL0799	195	SECB251131	47
PRI		PWCSPLO699	205	PWPGPL0899	195	SECB270231	48
PRIRBL0105	229	PWCSPLO799	205	RTT		SECB270931	48
PRIRBL0505	229	PWCSPLO899	205	RTTA57362501	213	SECB500931	48
PRIRBL3205	229	PWE		RTTA57402501	213	SECB811131	48
PRIRBL3405	229	PWENPL0199	189	RTTA60362501	213	SECB811931	48
PRIRCT0105	229	PWENPL0299	189	RTTA60402501	213	SECBAF9005	30
PRIRCT0505	229	PWENPL0399	189	RTTA62382501	213	SECBAPO301	29
PRIREV0105	229	PWENPL0499	189	RTTM28301201	211	SECBAPO305	29
PRIREV0505	229	PWENPL0599	190	RTTM38301201	211	SECBAPO308	29
PRIREV3205	229	PWENPL0699	190	RTTM38351201	211	SECBAPO9005	30
PRIREV3405	229	PWENPL0799	190	RTTM44351201	211	SECBAR0301	29
PRIRJL0105	229	PWENPL0899	190	RTTM57251201	211	SECBAR0305	29
PRIRJL0505	229	PWENPL0999	191	RTTM57271201	211	SECBAR0308	29
PRIRME0105	229	PWENPL1099	191	RTTM57301201	211	SECBAS0301	29
PRIRME0505	229	PWENPL1199	191	RTTM57321201	211	SECBAS0305	29
PRIRME3205	229	PWENPL1299	191	RTTM57351201	211	SECBAS0308	29
PRIRME3405	229	PWENPL1599	193	RTTM57601201	211	SECBAW0355	29
PRIRMX0105	229	PWENPL1699	193	RTTM57751201	211	SECBAW0360	29
PRIRMX0505	229	PWENPL1799	193	RTTM60601201	211	SECBAW0356	29
PRIROP0105	229	PWESPL0108	197	RTTM62351201	211	SECBAZ0101	28
PRIROP0505	229	PWESPL0208	197	RTTM80701201	211	SECBAZ0105	28
PRIRPN3205	229	PWESPL0308	197	RTTM80721201	211	SECBAZ0201	28
PRIRPN3405	229	PWESPL0408	197	RTTM80751201	211	SECBAZ0205	28
PRIRPX0105	229	PWESPL0508	198	RTTM80761201	211	SECBBG3017	19
PRIRPX0505	229	PWESPL0608	198	RTTM80801201	211	SECBBG3017	26
PRIRSK0105	229	PWESPL0708	198	RTPP57121201	212	SECBBG6417	19
PRIRSM0105	229	PWESPL0808	199	RTPP57151201	212	SECBBRBG99	53
PRIRSM0505	229	PWESPL0908	199	RTPP57161201	212	SECBBRPN99	53
PRIRSW0105	229	PWESPL1008	199	RTPP57181201	212	SECBC10032	19
PRIRSW0505	229	PWESPL1108	200	RTPP57201201	212	SECBC15532	19
PRIRTV0105	229	PWESPL1208	200	RU8		SECBC15532	19
PRIRTV0505	229	PWESPL1308	200	RU80302	263	SECBC20032	19
PRP		PWESPL1408	200	RU80305	263	SECBC30032	19
PRPRTEZ2250S	238	PWESPL1508	201	RU80306	263	SECBC36532	19
PRPRTEZ2350S	238	PWESPL1608	201	RU9		SECBCA0104	24
PRPRTG500S	237	PWESPL1708	198	RU91302	263	SECBCA0105	24
PRPRTG530S	237	PWESPL1808	199	RU91305	263	SECBCA0117	24
PRPRTTE200	236	PWESPL1908	201	RU91306	263	SECBCA0204	24
PRPRTZX1200S	239	PWESPL2008	201	RUC		SECBCA0205	24
PRPRTZX1300S	239	PWESPL2108	202	RUCR02	263	SECBCA0217	24
PRS		PWESPL2208	202	RUCR05	263	SECBCA0304	23
PRSW06L112	226	PWESPL2308	202	RUCR06	263	SECBCA0305	23
PRSW08L112	226	PWESPL2408	202	SEA		SECBCA0317	23
PRSW14L212	226	PWF		SEACFX0705	17	SECBCA0704	24

CODICE CODE	PAG. PAGE	CODICE CODE	PAG. PAGE	CODICE CODE	PAG. PAGE	CODICE CODE	PAG. PAGE
SECBCA0705	24	SECBL10531	47	SECTCPF208	13	SECTP13501	11
SECBCA0717	24	SECBL11931	48	SECTCPF308	13	SECTP13505	11
SECBCA0804	23	SECBL30931	48	SECTCR0205	15	SECTP15001	11
SECBCA0805	23	SECBL39931	48	SECTCS2601	41	SECTP15005	11
SECBCA0817	23	SECBM25631	48	SECTCS2622	41	SECTP18501	11
SECBCA0904	23	SECBPM3731	47	SECTCS3101	41	SECTP18505	11
SECBCA0905	23	SECBPS10	50	SECTCS3122	41	SECTP23501	11
SECBCA0917	23	SECBRX0501	28	SECTCS3234	41	SECTP23505	11
SECBCA1004	23	SECBRX0505	28	SECTCS4101	41	SECTP25001	11
SECBCA1005	23	SECBRX0508	28	SECTCS4122	41	SECTP25005	11
SECBCA1017	23	SECBRX1001	28	SECTCS5334	41	SECTP28501	11
SECBCP8107	50	SECBRX1005	28	SECTCT45	40	SECTP28505	11
SECBCS0105	22	SECBRX1008	28	SECTCT55	40	SECTP32601	10
SECBCS0104	22	SECBRX1501	28	SECTCT65	40	SECTP32605	10
SECBCS0204	22	SECBRX1505	28	SECTCT75	40	SECTP33501	10
SECBCS0205	22	SECBRX1508	28	SECTDP0105	38	SECTP33505	10
SECBCS0304	22	SECBS51632	20	SECTDP0205	38	SECTP35001	10
SECBCS0305	22	SECBS52232	20	SECTDP0305	38	SECTP35005	10
SECBCS0317	22	SECBS61632	20	SECTDP0405	38	SECTP38501	10
SECBCS0604	22	SECBS62232	20	SECTDP0705	37	SECTP38505	10
SECBCS0605	22	SECBSAP99	53	SECTDP0805	37	SECTP42601	10
SECBCS0704	22	SECBSB21	50	SECTDP0905	37	SECTP42605	10
SECBCS0705	22	SECBSP0101	47	SECTDP1005	37	SECTP43501	10
SECBCS0804	22	SECBSP0105	47	SECTDP1105	37	SECTP43505	10
SECBCS0805	22	SECBSP01201	47	SECTFF3401	43	SECTP45001	10
SECBCS0904	23	SECBSP01205	47	SECTFF3404	43	SECTP45005	10
SECBCS0905	23	SECBSP0201	47	SECTFF3405	43	SECTP48501	10
SECBCS2004	23	SECBSP0205	47	SECTFF3406	43	SECTP48505	10
SECBCS2005	23	SECBSP0301	47	SECTFF4101	43	SECTP51001	10
SECBD03201	50	SECBSP0305	47	SECTFF4104	43	SECTP51005	10
SECBD03205	50	SECBSP0401	47	SECTFF4105	43	SECTP52601	10
SECBDG3001	50	SECBSP0405	47	SECTFF4106	43	SECTP52605	10
SECBDG3005	50	SECBSQ1632	20	SECTFF5301	43	SECTP53501	10
SECBDR3201	50	SECBSQ1632	20	SECTFF5304	43	SECTP53505	10
SECBDR3205	50	SECBSQ2232	20	SECTFF5305	43	SECTP55001	10
SECBEGOE99	53	SECBSQ2232	20	SECTFF5306	43	SECTP55005	10
SECBEST101	28	SECBV24408	32	SECTFFMN01	43	SECTP58501	10
SECBEST105	28	SECBV26408	32	SECTFFMN04	43	SECTP58505	10
SECBEST108	28	SECBV28608	32	SECTFFMN05	43	SECTP58501	19
SECBEVP101	28	SECBVPC208	32	SECTFFMN06	43	SECTP58505	19
SECBEVP105	28	SECBVPD308	32	SECTFFPG01	43	SECTP62601	10
SECBEVP108	28	SECBVPX108	32	SECTFFPG04	43	SECTP62605	10
SECBFOPR99	53	SECBVT4408	32	SECTFFPG05	43	SECTP63501	10
SECBFRAA98	52	SECBVT6408	32	SECTFFPG06	43	SECTP63505	10
SECBFRA99	52	SECBVT8608	32	SECTFX0705	17	SECTP65001	10
SECBFRRBN99	52	SECFMP1301	45	SECTFX1205	17	SECTP65005	10
SECBFRA99	52	SECFMP4701	45	SECTGRTY01	12	SECTP68501	10
SECBFRRKW99	52	SECP603001	45	SECTGRTY05	12	SECTP68505	10
SECBFRLM99	52	SECP604001	45	SECTIC4505	21	SECTP68501	19
SECBFMA98	52	SECSMP0701	45	SECTIC4505	21	SECTP68505	19
SECBFML99	52	SECSMP1001	45	SECTIC6505	21	SECTP72601	10
SECBFPM99	52	SECSMP1001	45	SECTIC6505	21	SECTP72605	10
SECBFPP99	52	SECSMP1301	45	SECTLD1608	13	SECTP73501	10
SECBFRRD99	52	SECSMP2001	45	SECTLDC408	13	SECTP73505	10
SECBITAA99	53	SECSMP2201	45	SECTLDD708	13	SECTP75001	10
SECBITGA99	53	SECSMP3201	45	SECTLDF108	13	SECTP75005	10
SECBITP199	53	SECTBT0205	38	SECTLDF208	13	SECTP78501	10
SECBITP299	53	SECTBT0305	38	SECTLDF308	13	SECTP78505	10
SECBITP399	53	SECTBT0405	38	SECTLDG508	13	SECTP78501	19
SECBL10331	47	SECTBT0505	38	SECTP02601	11	SECTP78505	19
SECBL10431	47	SECTBT0605	38	SECTP02605	11	SECTPL2601	11

CODICE <i>CODE</i>	PAG. <i>PAGE</i>	CODICE <i>CODE</i>	PAG. <i>PAGE</i>	CODICE <i>CODE</i>	PAG. <i>PAGE</i>	CODICE <i>CODE</i>	PAG. <i>PAGE</i>
SECTPL2605	11	SEDVAGM405	170	SEDVM10001	174	SEEPWHCIFR	141
SECTPM2601	9	SEDVB10001	174	SEDVM12401	174	SEEPWHCTEL	139
SECTPM2605	9	SEDVB12401	174	SEDVM13301	174	SEEPWHCTFR	139
SECTPM6001	9	SEDVB13201	174	SEDVON5020	76	SEEPWHFX	139
SECTPM6005	9	SEDVBF2808	168	SEDVPM0108	174	SEEPWHPIEL	141
SECTPMA105	15	SEDVBF3308	168	SEDVPM0208	174	SEEPWHPIFR	141
SECTPMAA05	15	SEDVBF3608	168	SEDVPM0408	174	SEEPWHPLEL	139
SECTPMBB05	15	SEDVBF3808	168	SEDVR61508	34	SEEPWHPLFR	139
SECTPMCC05	15	SEDVBF4308	168	SEDVR63008	34	SEK	
SECTPMDD05	15	SEDVBF4608	168	SEDVR71508	34	SEKTPB01	26
SECTPMEE05	15	SEDVBF4808	168	SEDVR73008	34	SEKTPB02	26
SECTPN1001	9	SEDVCF2808	168	SEDVR81508	34	SEKTPB03	26
SECTPN1005	9	SEDVCF3308	168	SEDVR83008	34	SEKTPB04	26
SECTPN3001	9	SEDVCF3608	168	SEDVSA0108	176	SEKTPB05	26
SECTPN3005	9	SEDVCF3808	168	SEDVSA0208	176	SEKTPB06	26
SECTPN5001	9	SEDVCF4308	168	SEDVSDW108	169	SEKTPB07	26
SECTPN5005	9	SEDVCF4608	168	SEDVSEW108	169	SEM	
SECTPP3134	41	SEDVCF4808	168	SEDVSFW108	169	SEMI40FX	141
SECTPP3734	41	SEDVDF2808	168	SEDVSGW108	169	SEMIWHFX	141
SECTPX26W1	11	SEDVDF3308	168	SEDVSHW108	169	SEMNFE3605	17
SECTPX26W2	11	SEDVDF3608	168	SEDVSIW108	169	SEMNFE3605	17
SECTPX26W3	11	SEDVDF3808	168	SEDVSP02KT08	175	SEP	
SECTPX26W4	11	SEDVDF4308	168	SEDVSP04KT08	175	SEPBMPI005	31
SECTPY0905	20	SEDVDF4608	168	SEE		SEPCCG1T08	172
SECTPY0905	20	SEDVDF4808	168	SEEB40FX	139	SEPCCG2M08	172
SECTPY1605	20	SEDVF10001	174	SEEBWHFX	139	SEPCCG2T08	172
SECTPY1605	20	SEDVF13301	174	SEEP40CIEL	141	SET	
SECTVA0105	36	SEDVF3B008	171	SEEP40CIFR	141	SETPASCC01	50
SECTVA0205	36	SEDVF3B208	171	SEEP40CTEL	139	SETPSPCC05	50
SECTVA0305	36	SEDVF3B408	171	SEEP40CTFR	139	SLA	
SECTVA0405	36	SEDVF3M008	171	SEEP40FX	139	SLAKE00	244
SECTVA0505	36	SEDVF3M208	171	SEEP40PIEL	141	SLAKE001	244
SECTVA0605	36	SEDVF3M408	171	SEEP40PIFR	141	SLAKE002	244
SECTVA0705	36	SEDVF4B208	171	SEEP40PLEL	139	SLAKG000	244
SECTVA0805	36	SEDVF4B408	171	SEEP40PLFR	139	SLAKG001	244
SECTVA0905	36	SEDVF4M208	171	SEEP9FR612	137	SLAKG002	244
SECTVA1005	36	SEDVF4M408	171	SEEP9FR812	137	SLAKM000	244
SECTVA1105	36	SEDVF6B208	171	SEEPBEC205	31	SLAKM001	244
SECTVA1205	36	SEDVF6B408	171	SEEPBQ0220	31	SLAKM002	244
SECTVA1305	36	SEDVF6M008	171	SEEPBS4005	143	SLAKP000	245
SECTVA1505	36	SEDVF6M208	171	SEEPBSWH05	143	SLAKP001	245
SECTVA1605	36	SEDVF6M408	171	SEEPBW0305	146	SLAKP002	245
SECTVA1705	36	SEDVF8B208	171	SEEPBW0308	146	SLR	
SECTVA1805	37	SEDVF8B408	171	SEEPKA03	146	SLR155103	248
SECTVA1905	37	SEDVF8M208	171	SEEPCT0104	146	SLR292600	246
SECTWD2534	40	SEDVF8M408	171	SEEPCT0105	146	SLR292601	246
SECTWD3034	40	SEDVFPC108	170	SEEPCT0117	146	SLR303000	246
SECTWD3035	40	SEDVFPC208	170	SEEPFRA401	143	SLR303001	246
SECTWD8134	40	SEDVFPC308	170	SEEPFRA402	143	SLR403000	246
SECTWD9634	40	SEDVFPC408	170	SEEPFRA403	143	SLR403001	246
SECTYSC105	15	SEDVFPX108	170	SEEPFRA405	143	SLR404000	246
SECTYSC305	15	SEDVFPX208	170	SEEPFRA406	143	SLR40400030	247
SECTYSC505	15	SEDVFPX308	170	SEEPFRA407	143	SLR404001	246
SECTYTL105	15	SEDVFPX408	170	SEEPGF0812	137	SLR40400130	247
SECTYTR105	15	SEDVGAB201	172	SEEPGF1212	137	SLR404002	247
SED		SEDVGAB401	172	SEEPN0112	45	SLR404006	247
SEDPBSP105	17	SEDVGAM201	172	SEEPN0206	45	SLR4040F01	247
SEDPBSP105	17	SEDVGAM205	172	SEEPRTA407	146	SLR4040F06	247
SEDPCF0105	17	SEDVGAM401	172	SEEPRTC3	146	SLR4040F21	247
SEDVAF0208	174	SEDVGAM605	172	SEEPSLT105	143	SLR4040F88S	247
SEDVAFCL08	174	SEDVHDR108	34	SEEPWHCIEL	141	SLR502302	247

CODICE <i>CODE</i>	PAG. <i>PAGE</i>	CODICE <i>CODE</i>	PAG. <i>PAGE</i>
SLR505000	247	TLL	
SLR505001	247	TLL563020F	215
SLRD3300	248	TLL565020P	215
SLRD3301	248	TLL565020R	215
SLRD4000	248	TLL578065P	215
SLRD4001	248	TLL578065R	215
SLRD4006	248	TLL600030P	215
SLRD4007	247	TLL600030R	215
SLRD40F06	248	TLL600090P	215
SP8		TLL600090R	215
SP80302	263	TLL620150P	215
SP80305	263	UB1	
SP80306	263	UB196	160
SP9		UB1971000	160
SP91302	263	UB1971200	160
SP91305	263	UB197600	160
SP91306	263	UB197600	160
SPC		UB7	
SPCR02	263	UB719C	162
SPCR05	263	UBI	
SPCR06	263	UBI1971500	160
SPP		UBI1972000	160
SPPLEX6	123	UFF	
SPPLEX8	123	UFFLFL	161
SUP		UFFLFM	161
SUPLBIO	60	UFFLFS	161
SUPLCAR	60	UFFLFXL	161
SUPLCC	60	UFFLQL	162
SUPLCD	60	UFFLQM	162
SUPLCIT	60	UFFLQS	162
SUPLCON	60	UFFLQXL	162
SUPLOFF	60	UFFLRL	161
SUPLOFS	60	UFFLRM	161
SUPLPC	60	UFFLRXL	161
SUPLPDN	60	UFZ	
SUPLPK	60	UFZMCEM	162
SUPLPT	60	UFZMCFS	162
SUPLSC	60	UFZMEXLA	161,162
SUPLSG	60	UFZMLA	161,162
SUPLVEG	60	UFZMLCB	162
SUPLVGN	60	UFZMLSQ	162
SUPSBIO	60	UFZMLWB	162
SUPSFRE	60	UFZMME	161,162
SUPSN0V	60	UFZMPSS	162
SUPSO F	60	UFZMSCB	162
SUPSOFF	60	UFZMSM	161,162
SUPSPDN	60	VDC	
SUPSPES	60	VDCNWS	272
SUPSVGN	60	WD1	
SWS		WD102B	162
SWSDR35050070	122	ZFZ	
SWSDR35050070WP	122	ZFZMGS	162
SWSDR35060084	122		
SWSDR35060084WP	122		
SWSDR35070100	122		
SWSDR35070100WP	122		
SWSDR35084118	122		
SWSDR35084118WP	122		
TER			
TER60X60CDX	256,257		
TER80X80CDX	254,255		



L'azienda informa la gentile clientela che le dimensioni, i pesi, le misure, i colori dei prodotti e le caratteristiche in generale, sono meramente indicativi e potranno essere oggetto di variazioni. L'azienda non si ritiene responsabile di eventuali difformità rispetto a quanto riportato nel catalogo. Tutti i diritti sono riservati. La riproduzione, in ogni forma o di tutta la presente pubblicazione è vietata senza autorizzazione preventiva.

The company informs its customers of the dimensions, weights, sizes and colors of products and features in general, are merely indicative and used be subject to changes. The company is not responsible for any differences with respect to what is reported in the catalog. All rights reserved. Reproduction, in any form or throughout this publication it is prohibited without prior authorization.

Regia e grafica: **Gennaro Carola**

Editor: **Quattrociocchi Iole**

Photo: **Peruzza Daniele**



Contrada Ponte del Tremio snc
03012 - Anagni (Fr) - ITALY

Tel. (+39) 0775. 774581
0775. 772235
Fax (+39) 0775. 744410

email: info@globalte.it
www.globalte.it